

Since 1980/1993

KOSDAQ
LISTED COMPANY

Smart-Lab™ Sys.
On Mobile

Small Giant
Corp. of Korea

GOOD
DESIGN

Excellent
Service Quality

- ☑ CE Certified
- ☑ Excellent Service Quality - Certified
- ☑ Global Small Giant Corp. of Korea
- ☑ GMP Certified for Medical Instruments
- ☑ ISO 9001 Certified
- ☑ ISO 13485 Certified for Medical Instruments
- ☑ UL Certified
- ☑ PL Insurance, Validation(IQ & OQ) Service
- ☑ Patented(No. 10-0554098) Jog Shuttle Control System

ALLforLAB.com Open-market
DAIHAN-Analy.com
DAIHAN-Sci.com Shopping-mall
DAIHANused.com
LabRental.co.kr
Lab-Service.co.kr

2020 DAIHAN Scientific

Laboratory & Measuring Instruments
with **New & Renewed Products**



Sales & Service
- by the Nearest Distributors

DAIHAN Scientific
YOUR PARTNER in LABORATORY
Republic of Korea

Ordering & Inquiring

Easy, Fast, Comfortable & Economical!

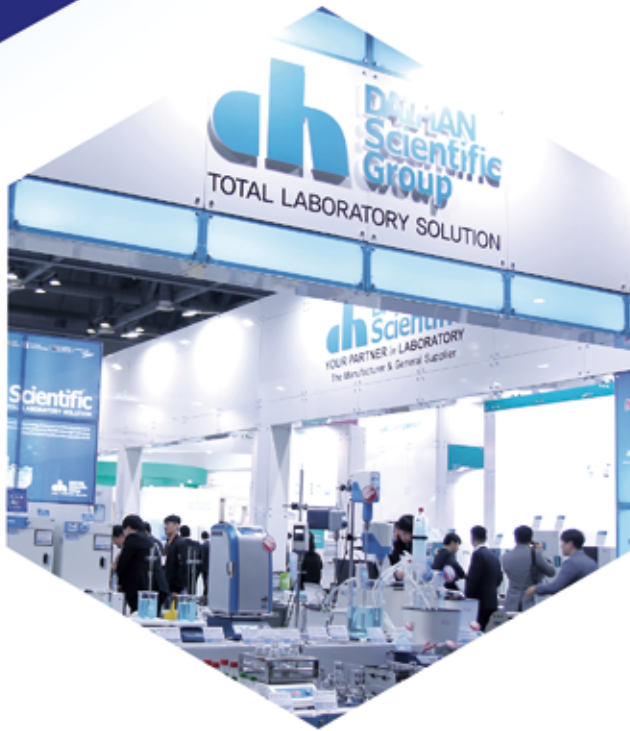

via Phone

DAIHAN's Official Distributor Nearest You
or DAIHAN Call Center
080-008-3000 or 070-5020-1516
Int'l : +82-2-967-5235



via Fax

DAIHAN's Official Distributor Nearest You
or DAIHAN Fax : 033-737-7575
Int'l : +82-2-963-5231



via Website

DAIHAN-Sci.com / ALLforLAB.com
DAIHANused.com
LabRental.co.kr
Lab-Service.co.kr



via Mail

daihan@daihansci.co.kr
Int'l : info@daihan-sci.com

DAIHAN Scientific Worldwide Distributors

The Representatives of DAIHAN Scientific
Please check our website "www.DAIHAN-Sci.com"



There is **DAIHAN** General Catalog
of Big Volume.
You can request the Catalog anytime.



DAIHAN Scientific was founded in 1980 and has been broadening its business as one of the leaders in global Laboratory market. We have been cooperating with 70 international distributors to support Laboratory customers with various kind of high-quality instruments under the brand of DAIHAN.

We've focused on extending the product lines with some new innovative products especially valuable for the customers in Life Science, Pharmaceutical, and Medical. This catalog provides the information of all the DAIHAN Product Lines, and you can get the same full information in our website, "DAIHAN-Sci.com" at any time and in any place in the world. DAIHAN would make its best efforts to be the best Service company for Customer Satisfaction rather than a simple manufacturer. Thank you very much.

Shu, Hyun Jeong
co-CEO / President

Shu, Chong Ku
co-CEO / Chairman

23 Jul. 2019

(주)대한과학

LAB RENTAL

Total Laboratory Solution

· DAIHANRental.co.kr

· LabRental.co.kr

국내 1위 기술력 대한과학의 업계 최초 실험장비 종합렌탈 서비스

- 부담없는 사용료 & 최상의 품질
- 할부구매식 인수렌탈
- 지속적인 유지보수 관리 서비스
- 필요시사용 일시렌탈

선택의 다양성

실험장비 종합렌탈 & 서비스



Direct Call.(수신자 부담)

대전 : 080-858-3001 서울 : 080-008-9009

E-mail.

rental@daihansci.co.kr

KOSDAQ LISTED COMPANY | Small Giant Corp. of Korea | Excellent Service Quality

· 중고장터 : DAIHANused.com, UsedLab.kr
· 대한과학쇼핑몰 : DAIHAN-Sci.com Shopping-mall

· 올포럼오픈마켓 : ALLforLAB.com Open-market
· 싸이랩쇼핑몰 : SciLab.kr Shopping-mall

(주)대한과학

LAB SERVICE

Total Laboratory Solution

· lab-service.co.kr

· Labas.kr

- 제조사에 구매없는 모든 실험장비의 유지보수 One Stop Service
- 전문가에 의한 안전한 실험장비 이전 설치 서비스
- 완벽한 절차의 적격성 평가 IQ & OQ Service
- 연구실험실 안전진단 포함 장비의 정기점검 및 유지보수 Total Solution

Full Service Network! Covering the Whole Nation



서비스 본부

Direct Call.(수신자 부담)

대전 : 080-858-3001 서울 : 080-008-9009
E-mail : service@daihansci.co.kr

전국 Service Network

- 광주 : 062-525-1155 (광주과학)
- 대구 : 053-381-8445 (대한과학대구)
- 부산 : 051-247-2875 (대한과학부산)
- 전주 : 063-277-8901 (대한과학전북)
- 진주 : 055-745-8622 (선일과학)
- 제주 : 064-721-7749 (금성하이텍)
- 청주 : 043-234-6200 (충북과학)
- 춘천 : 033-262-7720 (메디코아펙스)



A	
Autoclave ⇒ See Sterilizer	212 ~ 216
B	
Balance	11 ~ 26
Analytical	12 ~ 13
Electronic Laboratory New	14 ~ 16
General Purpose & Industry New	17 ~ 19
Healthcare-InBalance™	20 ~ 21
Moisture Analyzer	22
Accessory	23 ~ 25
Bath	26 ~ 32
Basic-type, 100°C / 250°C	27 ~ 28
Cold Trap	29
Extraction Water Bath	30
Shaking Water Bath	31
Viscosity Bath	32
Bath Circulator	33 ~ 37
Circulation Water Bath	33
High-temp. 250°C	34
Refrigerated / Heating	35 ~ 36
Accessory, Circulation Hose & Transfer Fluid New	37
Blender New	38
C	
Centrifuge	39 ~ 44
Mini-microcentrifuge	40
Pro-microcentrifuge	41 ~ 42
Table-top Classic	43
Table-top Microprocessor	44
Chiller/Cooling Circulator	45
D	
Desiccator Cabinet	46 ~ 49
Auto-Dry	48 ~ 49
Gas Exchangeable	47
General Purpose	47
UV Protection Auto-Dry	49
Vacuum	49
Accessory, Desiccant New	49
E	
Electrophoresis	50 ~ 53
Gel Documentation System	51 ~ 52
UV Transilluminator	53
Evaporator	54 ~ 61
Circulator Coolers "Chiller"	60
Rotary Vacuum Evaporator	55 ~ 59
0.1~5Lit Vertical-type New	55 ~ 56
0.5~2Lit Vertical & Diagonal-type	57
5~50Lit Large Capacity, Vertical-type	58 ~ 59
Vacuum Aspirator and Cooler	61
Vacuum Pump for Evaporator	178 ~ 179
F	
Freeze Dry System	62 ~ 63
Fume Hood	64 ~ 69
Clean Bench, Ductless	65 ~ 66
Ducted Fume Hood	67 ~ 69
Furnace	70 ~ 75
Muffle, 1000 & 1200°C	71 ~ 72
Muffle, High Temp. 1450 & 1650°C	73 ~ 74
Tube	75
Furniture	76 ~ 79
Assembly Sink & Table	76 ~ 78
Safety Cabinet	79
H	
Heating Block/Dry Bath Incubator	80 ~ 82
Heating	80 ~ 81
Heating & Cooling	82
Heating Circulator	83 ~ 84
250°C High-temp Bath Circulator	34, 83
-30+200°C Refrigerated / Heating External Circulator	84
Transfer Fluid New & Circulation Hose	83 ~ 84
Heating Mantle & Controller	85 ~ 94
Controller	94

For Beaker / Flask / Reaction Vessel	86 ~ 91
For Soxhlet Extraction, Multi	92
Heating Tapes & Custom-made	93
Homogenizer	95 ~ 99
Direct Control	96
Remote Digital Control	97
Tool & Stand	98
Homogenizing Stirrer	99
Hotplate	100 ~ 104
380°C, Analog & Digital	103
500°C, Solid Ceramic Glass	101 ~ 102
600°C, Hi-Light New	101
Large Plate, 350°C	104
Hotplate Stirrer	105 ~ 107
380°C, Analog & Digital	106
500°C, Solid Ceramic Glass	105
Systematic Multi, 350°C	107

I	
Ice Maker New	108
Incubator	109 ~ 139
CO ₂ Incubator New	110 ~ 111
General Low Temp Mini New	112
General Purpose	113 ~ 122
Forced-air / Gravity-air / Multi-Room	113 ~ 122
Heating Block / Dry Bath Incubator	123 ~ 125
Heating	123 ~ 124
Heating & Cooling	125
Humidity / Temp Test Chamber	126 ~ 128
Low Temp(B.O.D) Incubator	129 ~ 131
Plant Growth Chamber	132 ~ 133
Shaking Incubator New	134 ~ 139

J	
Jar Tester(6-Paddle)	236

M	
Magnifier, Fluorescent & LED Light	140
Measuring	141 ~ 160
Anemometer / Airflow Meter	141 ~ 142
Gas Detector / Meter	143 ~ 144
Manometer	145
Salinity Meter	145
Soil Analyzer	145
Sound Level(Noise) Meter	146
Tachometer	147
Thermo-Hygrometer New	148 ~ 150
Thermometer	151 ~ 164
Digital Infra-Red	151
Digital K-Type	152 ~ 154
Digital NTC-Type	155 ~ 159
Digital Pt100	160
Digital WBGT	160
Specialty	160
Melting Point Analyzer	161
Mill	162 ~ 164
Ball Mill	162
Cutting Mill & Pin Mill	163
Mill Mixer	164

O	
Oven	165 ~ 177
General Purpose Forced- / Gravity-air	166 ~ 173
High Clean Air	174
Industrial / Large-capacity	175
Vacuum	176 ~ 177
Pump for Vacuum Oven	178 ~ 179

P	
Pump New	178 ~ 179
Diaphragm Vacuum	179
Oil Free Vacuum	179
Oil Sealed Vacuum	178

R	
Reactor	180 ~ 185
Complete Set	182 ~ 185

AutoLifting	182
Classic	183 ~ 184
Mantle Heated	185
System Overview	181
Refrigerator & ULT Freezer	186 ~ 196
0(2)~10°C Blood Bank&Pharmaceutical New	187 ~ 188
0°C~10°C Cold Lab Chamber	189
-35°C Bio Freezer	190
Ultra-Low Temp. Freezer	191 ~ 196
-86°C Personal	192
-86°C Upright-type	193
-95°C Upright-type	194
Accessory, Racks / Boxes / etc.	195 ~ 196

S	
Safety Cabinet	197 ~ 201
For Chemicals	198 ~ 200
For Flammable	201
Shaker	202 ~ 210
Mixer	203 ~ 204
Orbital / Reciprocating Motion	205 ~ 208
Rocker	209
Rotor	210
Sterilizer	211 ~ 219
Autoclave	212 ~ 216
Bench-top New	214 ~ 215
Front Door New	216
Vertical	212 ~ 213
Dry Heat Sterilizer New	217
Plasma Sterilizer New	218 ~ 219
Sterilization Deodorant	213
Sterilization Indicator Tape & Label	213
Stirrer	220 ~ 243
Magnetic	221 ~ 224
High-performance	223
120 × 120 Mini & 180 × 180 Midi New	221
Multi-point	224
Standard Analog & Digital	222
Magnetic with Heating	225 ~ 227
350°C, Systematic Multi-point	227
380°C, Analog / Digital	226
500°C, Solid Ceramic Glass	225
Overhead	228 ~ 243
High-Speed New	229 ~ 231
High-Torque New	232 ~ 235
Jar tester(6-Paddle)	236
Accessory	236 ~ 243
Flexible Coupling	239
Stand & Clamp Holder	243
Stir-Guide / Seal	237 ~ 239
Stirring Shaft / Impeller New	239 ~ 242
Stirring Rod, Glass / PP / PTFE / STS	236 ~ 237

U	
Ultrasonic Cleaner	244 ~ 247
Analog & Digital	245 ~ 246
Remote Control, Large Capacity	247

V	
Viscosity, Rotary Viscometer	248 ~ 253
Multi-speed	250
Portable	253
Programmable	251
Remote Temp Control	252
Standard	249

W	
Washer, Glass / Labware Washer	254 ~ 255
Water Purification	256 ~ 262
Basic Water Still	257
Classic Water Still New	258 ~ 259
Water Purification System	260 ~ 262
Reverse Osmosis(RO)	260
Ultra Pure(UP)	261
Ultra Pure(UP) & Pure(RO)	262

2020 DAIHAN® Laboratory & Measuring Instruments “Overview”

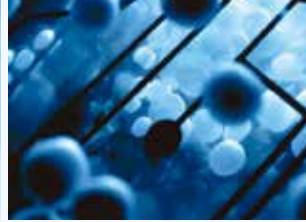

Balance



Analytical



Electronic Lab



General Purpose & Industry



InBalance™ Body Composition Analyzer



Moisture Analyzer

Bath



Basic Bath, 100~250 °C



Cold Trap Bath



Extraction Water Bath



Shaking Water Bath



Viscosity Bath

Bath Circulator

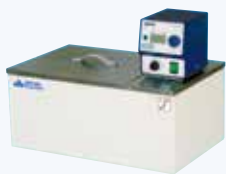

Circulation Water bath



Refrigerated / Heating

Blender



Sample Mixer

Centrifuge



Mini-micro Centrifuge



Pro-micro Centrifuge

Centrifuge



Table Top Centrifuge

Chiller/Cooling Circulator



Chiller / External Circulator

Desiccator Cabinet



Desiccator Cabinet

Electrophoresis



Gel Documentation System



UV Transilluminator

Evaporator



Rotary Vacuum Evaporator

Freeze Dry System



Bench-top Freeze Dryer

Fume Hood & Clean Bench



Clean Bench-Ductless



Fume Hood-Ducted

Furnace



Muffle Furnace, 1000~1650 °C

<Continued On Next Page>

All DAIHAN® Lab Instruments have a *1-1/2-Year Global Warranty*

Furniture



Laboratory Assembly-type

Heating Block / Dry Bath Incubator

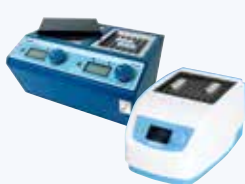

Heating Block

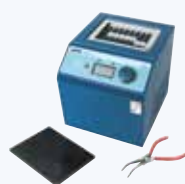

Heating & Cooling Block

Heating / Cooling Circulator



-30 ~ +200°C

External Circulator

Heating Mantle



Heating Mantle

Heating Mantle



Multi Heating Mantle

Homogenizer



Analog & Digital

Hotplate



600°C High-Temp. Hi-Light Hotplate



500°C High-Temp. Hotplate



380°C Hotplate Analog & Digital

Hotplate



350°C Large Plate Hotplate

Hotplate Stirrer



500°C High-Temp. Hotplate Stirrer



380°C Hotplate Stirrer Analog & Digital



Multi Hotplate Stirrer 3- / 6-places

Ice Maker



Ice Maker

Incubator



CO₂ Incubator



General Mini Low Temp / Shaking 20Lit



General Purpose Forced- & Gravity-air



General Purpose Multi, 4-room



Humidity / Temp. Chamber

Incubator



Low Temp (B.O.D) Incubator



Plant Growth Chamber



Shaking Incubator Front Door-type, 127Lit



Shaking Incubator Top Door-type, 101Lit



Shaking Incubator Top Door-type, 229Lit

<Continued On Next Page>

2020 DAIHAN® Laboratory & Measuring Instruments “Overview”

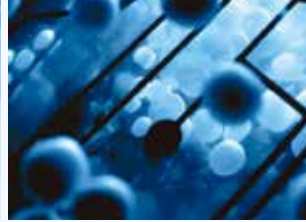

Incubator



Shaking Multi-Stack Incubator

Magnifier



Light Magnifier Fluorescent / LED

Measuring



Anemometer / Air Flow



Gas Detector / Monitor



Salinity Meter

Measuring



Sound Level (Noise) Meter



Thermo-Hygrometer



Thermometer, Infra-Red “IR”



Thermometer, K-type / NTC-type / Pt100 / WBG

Melting Point Analyzer



Melting Point Analyzer

Mill



Ball Mill



Cutting Mill & Pin Mill



Mill Mixer

Oven



General Oven Forced- & Gravity-air



High Clean Air Oven

Oven



Industrial Forced-air Oven



Vacuum Oven

Pump



Vacuum Pump

Reaction System



Reaction System for Lab & Pilot Plant Glass Vessel 0.1~100Lit.

Refrigerator



2~10°C Blood Bank & Pharmaceutical



0~10°C Lab Refrigerator



-35°C Bio Freezer



-86°C ULT Freezer, UniFreez™



-95°C ULT Freezer, DuoFreez™

<Continued On Next Page>

All DAIHAN® Lab Instruments have a *1-1/2-Year Global Warranty*

Safety Cabinet

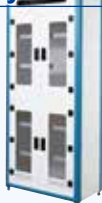

Cabinet for Chemicals, PP



Cabinet for Flammable, Steel

Shaker

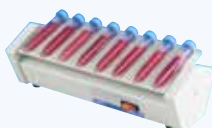

Mixer / Rocker



Mixer / Tube Rotor



Mixer / Vortex

Shaker



Orbital-/Reciprocating-Shaker



Rocker



Rotator

Sterilizer



Autoclave



Autoclave, Bench-top

Sterilizer



Autoclave, Front Door



Dry Heat Sterilizer



Plasma Sterilizer



Magnetic, Digital Mini & Midi



Magnetic, High-Performance

Stirrer, Magnetic



Magnetic, Multi-point

Stirrer, Overhead



Overhead, Hi-speed ~3000rpm



Overhead, Hi-torque ~200,000mPas



Overhead, Hi-torque Ultra ~350,000mPas

Ultrasonic Cleaner



Ultrasonic Cleaner

Viscosity



Rotary Viscometer

Washer



Glass / Labware Washer

Water Purification



Basic Water Still



Classic Water Still



UP & RO Filtration System

※ The Details ; Please See the “Sterilizer” Section, Page 212~216

Autoclave , Bench-top New	P. 214~215
, Front Door New	P. 216
, Vertical	P. 212~213
, Accessory New	P. 213

Coming Soon



Programmable Bench-top, 21.5Lit
“MaXterile™ B21”

NEW



Programmable Bench-top, 25 · 40 Lit
“MaXterile™ BT”

NEW



Front Door, 90Lit
“MaXterile™ FL90”



Vertical, 47 · 60 · 80 · 100 Lit
“MaXterile™ 80”

DAIHAN Scientific

Balance

Balance - Analytical	P. 12~13
- Electronic Laboratory New	P. 14~16
- General purpose & Industry New	P. 17~19
- Pocket	P. 11, 16
InBalance™ - 200	P. 20
- 300	P. 21
Moisture Analyzer	P. 22
Accessory	P. 23~25

“Auto Int-CAL”



Analytical Balance

“WBA-220A”

[d] 0.1mg, max.220g

“Ext-CAL”



Electronic Lab Balance

“Bal-D210S”

[d] 1mg, max.210g

“Ext-CAL”



Moisture Analyzer

“WBA-110M”

[d] 1mg, max.110g

DAIHAN® [d] 0.05g/0.2g, max.300g/1000g Pocket Digital Balance “Bap”, 9×14×2.4cm, 400g
With Counting Pcs · %, Function and Leather Case, Pocket-size Body, 포켓 디지털 바란스

“Ext-CAL”

[d] 0.05g, max.300g



1-Year Warranty

Pocket Balance, “Bap300”



■ **Made in Korea**

- * Ergonomic Design for Intuitive User Interface
- * Pcs. Counting & Weighing Mode
- * External Calibration

■ **CE Certified**

- * Ambient Temperature 5℃~35℃
- * Numeric Linearity Calibration
- * Included Battery(AAA 1.5V×3Ea)

■ **1-Year Warranty**

Specifications & Ordering information

Spec.	Model	“Bap300”	“Bap1.0k”
Weighing Range. g		max.300g	max.1000g
Weighing Plate. mm		68×85 mm	
Read-Out [d] & Reproducibility. g		0.05 g & 0.05 g	0.2 g & 0.2 g
Material		Body : ABS, Platform : Stainless-steel	
Dimension & Weight		90×140×h24 mm, and 0.4 kg	
Packing & Gross Weight		95×160×h35 mm, and 0.5 kg	
Power Supply		AAA Battery(DC 1.5V)	
Cat. No.		DH.Bal3011	DH.Bal3012
Price, Each. ₩			

DAIHAN® [d] 0.1mg, max.220g Standard Analytical Balance, Ext-CAL "WBA-220", Auto Int-CAL "WBA-220A"
 With Glass Draft Shield, Backlit LCD, Counting Function, Various Weight Mode, ϕ 80 / 90mm Weighing Plate
 "Ext-CAL 외부 보정형" & "Int-CAL 자동 보정형" 표준 분석/화학 천평, 계수계 겸용, 작업보호커버 포함



- Made in Korea
- CE Certified
- PL(Product Liability) Insurance
- with Certificate & Traceability : Controlled by Serial Number, Certificate, Delivery-information, and Traceable Data Base System
- Available Counting & Weighing Mode
- Various Weight Mode (g/ct%/GN/dwt/etc)
- Numeric Linearity Calibration
- Weighing Response Time Adjustable
- Blue Back Light LCD
- Supplied with : - ϕ 80/90mm Weighing Plate and Glass Draft Shield
 - AC 230V Adapter for DC Power 15V / 500mA(WBA-220A)
 - 200g Calibration Weight (Ext-CAL Model)

- * Ambient Temperature 5.0~35°C
- * Stabilization Time(Typical at Fast) \leq 8 Seconds
- * Appearance Parameters
- * Built in RS232C for Printer
- * Built in Under Hook
- * Electro Magnetic Base

Specifications & Ordering information

Spec.	Model	"WBA-220" Ext-CAL	"WBA-220A" Auto Int-CAL
Weighing Range. g		max.220 g	
Weighing Plate. mm		ϕ 80 mm	ϕ 90 mm
Read-Out [d]. mg		0.1 mg	
Reproducibility. mg		0.1 mg	
Linearity. mg		0.1 mg	
Ambien Temperature		5.0~35°C	
Weight Mode		g / ct	g / ct / % / GN / dwt / etc.
Counting Mode		Available Counting & Weighing Mode	
Calibration		External Calibration, Included 200g Calibration Weight	Internal Calibration, AUTO
Display		Digital LCD with Back-Light Function	
Dimension & Net Weight		190 × 240 × h265mm / 6.3 kg	223 × 345 × h331mm / 5.7 kg
Packing Size & Gross Weight		290 × 420 × h490mm / 8.3 kg	390 × 510 × h520mm / 10.1 kg
Electrical Reqts.		AC 220V, 50 / 60Hz	DC 15V, with AC 230V Adapter, 50/60Hz
Cat. No.		DH.WBA0220	DH.WBA0220A
Price, Each. ₩			



Optional Thermal Printer

* Model Name Required for Printer Installation

- | | | Ea. Price, ₩ |
|-------------|---|--------------|
| SL.WBA.100P | (1) Thermal Printer, Paper Roll, "WBA-100"
Included Cable Module, 1 × Paper Roll | |
| DH.WBA0084 | Thermal Paper Package, 5 × Paper Roll, for "WBA-100" | |
| SL.WBA.420P | (2) Thermal Printer, Label Paper Roll, "WBA-420"
Included Cable Module, 1 × Label Paper Roll | |
| DH.WBA0771 | Thermal Label Paper Package, 5 × Label Paper Roll, for "WBA-420" | |



(1) RS-232C Thermal Printer, "WBA-100"



(2) RS-232C Thermal Label Printer, "WBA-420"

Articles	Cat. No	Description
----------	---------	-------------

DAIHAN® [d] 1mg, max.320g/620g Hi-Precision Lab Balance, Ext-CAL “WBA-320/620”, Int-CAL “WBA-620A”
 With Glass Draft Shield, Super Size Backlit LCD, Counting Function, Various Weight Mode, ϕ 90 / 110 / 128mm Weighing Plate
 “Ext-CAL 외부 보정형” & “Int-CAL 자동 보정형” 다기능 랩 바란스, g / 계수 / % 측정, 작업보호커버 포함

“Ext-CAL”
[d] 1mg, max.320g / 620g



CE



Included 200g
Calibration Weight

2-Year Warranty

Ext-CAL “WBA-320” & “WBA-620”

- Made in Korea
 - CE Certified
 - PL(Product Liability) Insurance
 - with Certificate & Traceability : Controlled by Serial Number, Certificate, Delivery-information, and Traceable Data Base System
 - Available Counting & Weighing Mode
 - Various Weight Mode (g/ct/GN/dwt/etc.) and Percent(%) Weighing Mode
 - Numeric Linearity Calibration
 - Time & Date Setting for Recording Data
 - Supplied with : - Glass Draft Shield
 - 200g or 500g Calibration Weight (WBA-320 : 200g, WBA-620 : 500g)
 - AC Adapter for DC Power 12V/500mA(WBA-320), 15V/300mA(WBA-620/620A)
 - Available Rechargeable Battery(WBA-320, 6V/1.2A, Excluded)
 - Four Level Anti-shock Adjustable Function
 - Weighing Response Time Adjustable
 - For Both AC and DC
 - Super Size Back Light LCD
- * Ambient Temperature 5.0~35℃
- * Stabilization Time(Typical at Fast) ≤ 8 Seconds
- * Default and Auto Lock Present Working Mode
- * Built in RS232C & USB port for Printer
- * Electro Magnetic Base
- * Display Present Temperature
- * Built in Under Hook

Specifications & Ordering information

Spec.	Model	“WBA-320” Ext-CAL, 320g	“WBA-620” Ext-CAL, 620g	“WBA-620A” Auto Int-CAL, 620g
Weighing Range. g		max.320 g	max.620 g	
Weighing Plate. mm		ϕ 90 mm	ϕ 128 mm	ϕ 110 mm
Read-Out [d]. g		0.001 g		
Reproducibility. g		0.001 g		
Linearity. g		0.001 g		
Ambient Temp.		5.0~35℃		
Weight Mode		% Mode and Available g-/ct-/GN-/dwt-/etc.		
Counting Mode		Available Counting & Weighing Mode		
Calibration		External Calibration		Internal Calibration
		Included 200g Calibration Weight	Included 500g Calibration Weight	AUTO
Display		Digital Super Size LCD with Back-Light Function		
Dimension & Net Weight		223×345×h331mm 3.6 kg	223×345×h331mm 5.7 kg	
Packing Size & Gross Weight		290×385×h365mm 5.1 kg	390×510×h520mm 10.1 kg	
Electrical Reqts.		DC 12V, with AC 230V Adapter, 50/60Hz	DC 15V, with AC 230V Adapter, 50/60Hz	
Cat. No.		DH.WBA0320	DH.WBA0620	DH.WBA0620A
Price, Each. ₩				

“Auto Int-CAL”
[d] 1mg, max.620g



CE

2-Year Warranty

Int-CAL “WBA-620A”

Optional Thermal Printer

* Model Name Required for Printer Installation

- | | Ea. Price, ₩ |
|--|--------------|
| SL.WBA.100P (1) Thermal Printer, Paper Roll, “WBA-100”
Included Cable Module, 1×Paper Roll | |
| DH.WBA0084 Thermal Paper Package, 5×Paper Roll, for “WBA-100” | |
| SL.WBA.420P (2) Thermal Printer, Label Paper Roll, “WBA-420”
Included Cable Module, 1×Label Paper Roll | |
| DH.WBA0771 Thermal Label Paper Package, 5×Label Paper Roll, for “WBA-420” | |



(1) RS-232C Thermal Printer, “WBA-100”



(2) RS-232C Thermal Label Printer, “WBA-420”

DAIHAN® [d] 1mg/10mg, max.210g/2100g High-Precision Lab Balance “Bal-D”, Ext-CAL, RS-232C **NEW**
 With Counting Function, Various Weight Mode, DC Adaptor, Basic & Shield Type, 정밀 랩 바란스, 계수계 겸용

NEW

“Ext-CAL”
[d] 0.01g, max.2100g



CE

1-Year Warranty

(1) Basic-type, “Bal-D2100”

- Made in Korea
- CE Certified
- 1-Year Warranty
- Digital Large LCD Display and Ergonomic Design
- * Pcs. Counting & Weighing Mode
- * Easy Operation Weighing Mode : Gram, Metric, and Carat
- * Material : Stainless-steel Weighing Plate and ABS Resin Body
- * Stabilization Time : 3Sec
- * Permissible Ambient Temp. 5℃~35℃
- * RS-232C Interface and Level-Gauge integrated
- * Rechargeable Battery integrated, and with AC 230V Adaptor for DC Power 12V/300mA
- * External Calibration

(1) Basic-type Precision Balance

Specifications & Ordering Information

Spec.	Model	Bal-D210	Bal-D2100
Weighing Range. g		max.210g	max.2100g
Read-Out [d]. g		0.001g	0.01g
Reproducibility. g		0.001g	0.01g
Linearity. g		0.001g	0.01g
Weighing Mode		g, PCS, %	
Display		Digital LCD with Back-Light Function(110×h35mm)	
Weighing Plate. mm		129×119mm	
Dimension & Weight		170×250×h65mm, 1.4kg	
Packing & Gross Weight		210×300×h70mm, 1.6kg	
Power Supply		Adaptor DC 12V/300mA, 220V/60Hz	
Cat. No.		DH.Bal8051	DH.Bal8056
Price, Each. ₩			

NEW

“Ext-CAL”
[d] 0.001g, max.210g



CE

1-Year Warranty

(2) Glass Shield-type, “Bal-D210S”

(2) Glass Draft Shield-type Precision Balance

Specifications & Ordering Information

Spec.	Model	Bal-D210S	Bal-D2100S
Weighing Range. g		max.210g	max.2100g
Read-Out [d]. g		0.001g	0.01g
Reproducibility. g		0.001g	0.01g
Linearity. g		0.001g	0.01g
Weighing Mode		g, PCS, %	
Display		Digital LCD with Back-Light Function(110×h35mm)	
Weighing Plate. mm		φ80mm	
Dimension & Weight		170×250×h135mm, 1.7kg	
Packing & Gross Weight		210×300×h150mm, 2.5kg	
Power Supply		Adaptor DC 12V/300mA, 220V/60Hz	
Cat. No.		DH.Bal8061	DH.Bal8066
Price, Each. ₩			



(3) RS-232C Thermal Printer, “WBA-100”



(4) RS-232C Thermal Label Printer, “WBA-420”

Optional Thermal Printer

* Model Name Required for Printer Installation

- SL.WBA.100P (3) Thermal Printer, Paper Roll, “WBA-100”
Included Cable Module, 1×Paper Roll
- DH.WBA0084 Thermal Paper Package, 5×Paper Roll, for “WBA-100”
- SL.WBA.420P (4) Thermal Printer, Label Paper Roll, “WBA-420”
Included Cable Module, 1×Label Paper Roll
- DH.WBA0771 Thermal Label Paper Package, 5×Label Paper Roll, for “WBA-420”

Ea. Price, ₩

Articles	Cat. No	Description
----------	---------	-------------

DAIHAN® [d] 0.01g, max.3200g/6200g Hi-Standard Lab Balance “WBA-3200/6200”, 168×168mm Weighing Plate With Super Size Back Light LCD, Counting Function, Ext-CAL, 2kg Cali. Weight, Various Weight Mode, with Certi. & Traceability 표준 다용도 랩 바란스, g / 계수 / % 측정, Ext-CAL(표준분동 포함), 4각 플레이트

“Ext-CAL”
[d] 0.01g, max.3200g



CE

2-Year Warranty



**Included 2kg(1kg×2Ea)
Calibration Weight
(Only “WBA-3200” model)**

Hi-Standard Lab Balance, “WBA-3200”

- Made in Korea
 - CE Certified
 - PL(Product Liability) Insurance
 - with Certificate & Traceability : Controlled by Serial Number, Certificate, Delivery-information, and Traceable Data Base System
 - Available Counting & Weighing Mode
 - Various Weight Mode (g/ct/GN/dwt/etc.) and Percent(%) Weighing Mode
 - External Calibration
 - Numeric Linearity Calibration
 - For Both AC and DC
 - Includes AC 230V Adapter for DC Power 12V/500mA
 - Available Rechargeable Battery (6V/1.2A, Excluded)
 - Four Level Anti-shock Adjustable Function
 - Time & Date Setting for Recording Data
 - Weighing Response Time Adjustable
 - Super Size Back Light LCD
- * Ambient Temperature 5.0 ~ 35℃
- * Stabilization Time(Typically Fast) ≤ 8 Seconds
- * Default and Auto Lock Present Working Mode
- * Display Present Temperature
- * Included 2kg(1kg×2Ea.) Calibration Weight (only WBA-3200)
- * Built in RS232C & USB port for Printer
- * Built in Under Hook
- * Electro Magnetic Base
- * Glass Draft Shield(Optional)

Specifications & Ordering information

Spec.	Model	“WBA-3200”	“WBA-6200”
Weighing Range. g		max.3200 g	max.3200 g
Weighing Plate. mm		168×168 mm	
Read-Out [d]. g		0.01 g	
Reproducibility. g		0.01 g	
Linearity. g		0.01 g	
Ambient Temperature		5.0~35℃	
Weight Mode		% Mode and Available g-/ct-/GN-/dwt-/etc.	
Counting Mode		Available Counting & Weighing Mode	
Calibration		External Calibration	
		Included 2kg Calibration Weight	none
Display		Digital Super Size LCD with Back-Light Function	
Dimension & Net Weight		195×295×h90mm / 2.6 kg	
Packing Size & Gross Weight		243×377×h163mm / 3.2 kg	
Electrical Reqts.		DC 12V, with AC 230V Adapter, 50/60Hz	
Cat. No.		DH.WBA3200	DH.WBA6200
Price, Each. ₩			



(1) Glass Draft Shield (Optional)



(2) RS-232C Thermal Printer, “WBA-100”



(3) RS-232C Thermal Label Printer, “WBA-420”

Optional Glass Draft Shield

* Target Model Required for Shielding Installation

DH.WBA0003 (1) Glass Draft Shield, 3 Slide Doors(Left, Right, Top), 175×195×h230 mm

Ea. Price, ₩	
--------------	--

Optional Thermal Printer

* Model Name Required for Printer Installation

SL.WBA.100P (2) Thermal Printer, Paper Roll, “WBA-100”
Included Cable Module, 1×Paper Roll

DH.WBA0084 Thermal Paper Package, 5×Paper Roll, for “WBA-100”

SL.WBA.420P (3) Thermal Printer, Label Paper Roll, “WBA-420”
Included Cable Module, 1×Label Paper Roll

DH.WBA0771 Thermal Label Paper Package, 5×Label Paper Roll, for “WBA-420”

Ea. Price, ₩	
--------------	--

DAIHAN® [d] 0.01g/0.1g, max.610g/6100g Multi-use Digital Balance “Ba-series”, RS-232C, DC & AC Adapter With g/Metric/Pcs/%/Carat/CHK/Bargraph/Density test-Function, 다용도 전자 바란스, 무게/계수/퍼센트/캐럿/비교계량/비중측정 & 동물계량 기능

- **Made in Korea** ■ **CE Certified** ■ **1-Year Warranty** ■ **Digital Large LCD Display and Ergonomic Design**
- * Metric Function : Animal Weighing, Bar-Graph Display, Comparison Weighing CHK, Counting 10~100 Pcs., Density Determination, Percent % and Sub-Scale Dual Display
- * Easy Operation Weighing Mode : Gram, Metric, and Carat
- * 5 × Touch Key : 1/2D*, MODE, ZERO, TARE, ENTER, and PRINT
- * Material : Stainless-steel Weighing Plate and ABS Resin Body
- * 3Sec. Stabilization Time, and Permissible Ambient Temp. 5°C~35°C
- * RS-232C Interface and Level-Gauge integrated
- * Rechargeable Battery integrated, and with AC 230V Adapter for DC Power 12V/300mA
- * External Calibration

(1) [d] 0.01g, max.210~610g Model, Multi-use Balance



“Ext-CAL”
[d] 0.01g, max.610g

1-Year Warranty

(1) Multi-use Balance, “Ba610”

Specifications & Ordering information

Spec.	Model	“Ba210”	“Ba310”	“Ba610”
Weighing Range max.		210 g	310 g	610 g
Read-Out [d] & Reproducibility. g		0.01 g & 0.01 g		
Linearity. g		0.01 g		
Weighing Mode		Gram, Metric, Carat		
Weighing Plate. mm		120×130 mm Stainless-steel		
Color		Light Grey-color	Silver-color	
Dimension & Weight		170×250×h65 mm, and 0.8 kg		
Packing & Gross Weight		210×315×h115 mm, and 1.7 kg		
DC Power & AC Adapter		with Rechargeable Battery & AC 220V Adapter		
Cat. No.		DH.Bal8011	DH.Bal8012	DH.Bal8013
Price, Each. ₩				

(2) [d] 0.1g, max.2100~6100g Model, Multi-use Balance



“Ext-CAL”
[d] 0.1g, max.6100g

1-Year Warranty

(2) Multi-use Balance, “Ba6.1k”

Specifications & Ordering information

Spec.	Model	“Ba2.1k”	“Ba3.1k”	“Ba6.1k”
Weighing Range max.		2100 g	3100 g	6100 g
Read-Out [d] & Reproducibility. g		0.1 g & 0.1 g		
Linearity. g		0.1 g		
Weighing Mode		Gram, Metric, Carat		
Weighing Plate. mm		160×170 mm Stainless-steel		
Color		Light Grey-color	Silver-color	
Dimension & Weight		170×250×h65 mm, and 1.0 kg		
Packing & Gross Weight		210×315×h115 mm / 1.9 kg		
DC Power & AC Adapter		with Rechargeable Battery & AC 220V Adapter		
Cat. No.		DH.Bal8015	DH.Bal8016	DH.Bal8017
Price, Each. ₩				

DAIHAN® [d] 0.05g/0.2g, max.300g/1000g Pocket Digital Balance “Bap”, 9×14×2.4cm, 400g With Counting Pcs · %, Function and Leather Case, Pocket-size Body, 포켓 디지털 바란스



“Ext-CAL”
[d] 0.05g, max.300g

1-Year Warranty

Pocket Balance, “Bap300”

- **Made in Korea** ■ **CE Certified** ■ **1-Year Warranty**
- * Ergonomic Design for Intuitive User Interface
- * Ambient Temperature 5°C~35°C
- * Pcs. Counting & Weighing Mode
- * Numeric Linearity Calibration
- * External Calibration
- * LCD-display
- * Included Battery(AAA 1.5V×3Ea)

Specifications & Ordering information

Spec.	Model	“Bap300”	“Bap1.0k”
Weighing Range. g		max.300g	max.1000g
Weighing Plate. mm		68×85 mm	
Read-Out [d] & Reproducibility. g		0.05 g & 0.05 g	0.2 g & 0.2 g
Material		Body : ABS, Platform : Stainless-steel	
Dimension & Weight		90×140×h24 mm, and 0.4 kg	
Packing & Gross Weight		95×160×h35 mm, and 0.5 kg	
Power Supply		AAA Battery(DC 1.5V)	
Cat. No.		DH.Bal3011	DH.Bal3012
Price, Each. ₩			

Articles	Cat. No	Description
----------	---------	-------------

DAIHAN® [d] 0.1g/1g, max.610g/6100g Digital Basic Balance “Bap”, 10~100 Pcs. Counting
 With Pcs. Count · Bargraph · LCD Display, with DC & AC Adapter, 디지털 기본형 바란스

- **Made in Korea**
- **CE Certified**
- * Digital Large LCD Display and Ergonomic Design
- * 10~100 Pcs. Counting and Bar-graph Display Function
- * Material : Stainless-steel Weighing Plate and ABS Resin Body
- * AA Battery and AC 230V Adapter for DC Power 12V/300mA

- **1-Year Warranty**
- **External Calibration**
- * Easy Operation, Sturdy and Balancing with Level Gauge
- * 4 × Touch Key : MODE, ZERO, TARE, and ENTER
- * Fast Stabilization Time - 3 Seconds
- * Permissible Ambient Temp. 5°C~35°C

(1) [d] 0.1g, max.310g/610g Model, Basic Balance



1-Year Warranty

(1) Basic Balance, “Bap610”

Specifications & Ordering information

Spec.	Model	“Bap310”	“Bap610”
Weighing Range. g		max.310 g	max.610 g
Read-Out [d] & Reproducibility. g		0.1 g & 0.1 g	
Linearity. g		0.1 g	
Weighing Mode		Gram	
Weighing Plate. mm		120 × 130 mm Stainless-steel	
Color Light		Grey-color	Silver-color
Dimension & Weight		170 × 250 × h65 mm, and 0.8 kg	
Packing & Gross Weight		210 × 315 × h115 mm, and 1.7 kg	
DC Power & AC Adapter		with Rechargeable Battery & AC 220V Adapter	
Cat. No.		DH.Bal8025	DH.Bal8026
Price, Each. ₩			

(2) [d] 1g, max.6100g Model, Basic Balance



1-Year Warranty

(2) Basic Balance, “Ba6.1kS”

Specifications & Ordering information

Spec.	Model	“Ba6.1kS”
Weighing Range. g		max.6100 g
Read-Out [d] & Reproducibility. g		1 g & 1 g
Linearity. g		1 g
Weighing Mode		Gram
Weighing Plate. mm		160 × 170 mm Stainless-steel
Color Light		Silver-color
Dimension & Weight		170 × 250 × h65 mm, and 1.0 kg
Packing & Gross Weight		210 × 315 × h115 mm, and 1.9 kg
DC Power & AC Adapter		with Rechargeable Battery & AC 220V Adapter
Cat. No.		DH.Bal8031
Price, Each. ₩		

DAIHAN® [d] 0.1g/1g, max.610g/6100g Simple Weighing Digital Balance “Bas”, Compact : 17.5 × 24 × 6cm & 600g
 Good for Saving Money, with Pcs. Counting, Back Light LCD, Battery, without Adapter, 단순계량 바란스, 계수 기능



1-Year Warranty

Simple Weighing Digital Balance “Bas610”

- **Made in Korea**
- **CE Certified**
- **1-Year Warranty**
- * Ergonomic Design for Intuitive User Interface
- * Pcs. Counting & Weighing Mode
- * Ambient Temperature 5°C~35°C
- * Digital LCD with Backlight
- * External Calibration
- * Numeric Linearity Calibration

Specifications & Ordering information

Spec.	Model	“Bas610”	“Bas6.1k”
Weighing Range. g		max.610 g	max.6100 g
Weighing Plate. mm		155 × 155 mm	
Read-Out [d] & Reproducibility. g		0.1 g & 0.1 g	1 g & 1 g
Material		Body : ABS, Platform : Stainless-steel	
Dimension & Weight		175 × 240 × h60 mm, and 0.6 kg	
Packing & Gross Weight		280 × 180 × h80 mm, and 0.8 kg	
Power Supply		DC 9V/300mA / AA × 2Ea.	
Cat. No.		DH.Bal8021	DH.Bal8022
Price, Each. ₩			

Innotem® [d] 2g/10g, max.10kg/30kg Rechargeable Waterproof Digital Balance "T-28K", **Commercial Use-Approved** **NEW**
 With Stainless Steel Tray, Bluetooth Communication Model, Pcs. Counting, 150hr-Run, **충전형 방수 상용바란스**



Waterproof Balance, "T-2810K"

- Made in Korea
- Digital LCD Display
- CE Certified
- Pcs. Counting

* Integrated Rechargeable Battery(150hr-Run)
 * Material : Stainless-steel Platform(230 × 190 mm) and ABS Resin Body
 * AC 220V Adapter for DC Power 12V / 1.5A

Specifications & Ordering information

Spec.	Model	"T-2810K"	"T-2830K"
Weighing Range. g		max.10kg	max.30kg
Read-Out [d]. g		2g	10g
Reproducibility. g		2g	10g
Linearity. g		2g	10g
Display		LCD, 5 Digit (100 × h40mm), Back Light On/Off	
Weighing Mode		g, kg, PCS	
Platform Size. mm		230 × 190 mm	
Material		Body : ABS, Platform : Stainless-steel Tray	
Dimension & Weight		230 × 240 × h170mm, 2.7kg	
Packing & Gross Weight		350 × 260 × h265mm, 3.6kg	
Electrical Requirements		Adaptor DC 12V/1.5A, 220V/60Hz	
Cat. No.		I7.T2810	I7.T2810
Price, Each. ₩			

DAIHAN® [d] 0.1g/0.5g, max.32kg/60kg Precision High Capacity Digital Bench Scale "Bah32P" & "Bah60P"
 With Pcs. · % · Alarm · Print & Check Function and Rechargeable Battery/Back Light & LCD Display, DC & AC Adapter
정밀 대용량 다기능 바란스, Pcs. 계수 · % · 경보음 · 인쇄 및 체크 기능, 재충전 배터리/백라이트 내장

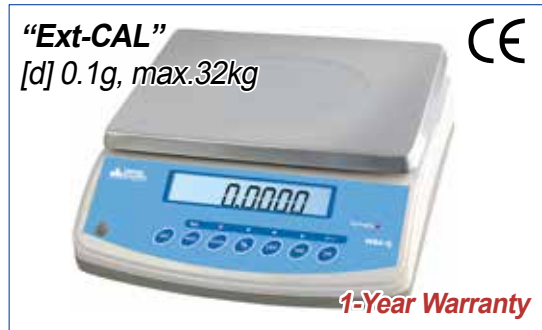

Bench Scale, "Bah32P"

- Made in Korea
- Digital : 3 × 6 digits LCD display, 20mm Digits, and Sturdy/Ergonomic Design
- 7 × Touch Key for "Bah32P" : UNIT, PRINT, FUNC., %, LIMIT, TARE, and ZERO
- 6 × Touch Key for "Bah61P Series" : UNIT, M+, G/N, TARE, ZERO and ON/OFF
- Easy Operation & Multi-Function : Alarm, Check, Counting Pcs., Percent %, and Print. "RS-232C" : Option for "Bah32P", and Standard for "Bah61P" (integrated)

* Integrated Rechargeable Battery(100Hr-Run) and Back Light
 * Very Fast Stabilization Time : 2 Seconds
 * Permissible Ambient Temp. -10℃ ~ +40℃
 * Material : Stainless-steel Platform and ABS Resin Body
 * External Calibration * with AC 220V Adapter for DC Power 9V / 850mA

Specifications & Ordering information

Spec.	Model	"Bah32P"	"Bah60P"
Weighing Range		max.32kg	max.60kg
Read-Out [d]. g		0.1 g	0.5 g
Reproducibility. g		0.1 g	0.5 g
Linearity. g		0.1 g	0.5 g
RS-232C interface		Option	Integrated
Weighing Plate. mm		225 × 300 mm	355 × 320 mm
Dimension & Weight		320 × 340 × h125mm, 3.8kg	355 × 320 × h130 mm, 6.3kg
Packing & Gross Weight		370 × 440 × h210mm, 4.6kg	500 × 450 × h230 mm, 7.3kg
DC Power & AC Adapter		with Rechargeable Battery & AC 220V Adapter	
Cat. No.		DH.Bal8035	DH.Bal8036
Price, Each. ₩			



Bench Scale, "Bah60P"

Articles

Cat. No

Description

DAIHAN® [d] 0.5g/1g, max.15kg/30kg Basic High Capacity Digital Bench Scale “Bah15L” & “Bah30L”
With Pcs. · % · Alarm · Print & Check Function and Rechargeable Battery/Back Light & LCD Display, DC & AC Adapter
기본형 대용량 다기능 바란스, Pcs. 계수 · % · 경보음 · 인쇄 및 체크 기능, 재충전 배터리/백라이트 내장

“Ext-CAL”
[d] 0.5g, max.15kg



1-Year Warranty

Bench Scale, “Bah15L”

- Made in Korea
- CE Certified
- 1-Year Warranty
- Digital : 3×6 digits LCD display, 20mm Digits, and Sturdy/Ergonomic Design
- 7× Touch Key : UNIT, PRINT, FUNC., %, LIMIT, TARE, and ZERO
- Easy Operation & Multi-Function : Alarm, Check, Counting Pcs., Percent %, and Print. “RS-232C”-Option

- * Integrated Rechargeable Battery(100Hr-Run) and Back Light
- * Very Fast Stabilization Time : 2 Seconds
- * Permissible Ambient Temp. -10℃~ +40℃
- * Material : Stainless-steel Platform and ABS Resin Body
- * External Calibration
- * with AC 220V Adapter for DC Power 9V / 850mA

Specifications & Ordering information

Spec.	Model	“Bah15L”	“Bah30L”
Weighing Range. g		max.15kg	max.30kg
Read-Out [d]. g		0.5 g	1 g
Reproducibility. g		0.5 g	1 g
Linearity. g		0.5 g	1 g
Weighing Plate. mm		225 × 300 mm	
Dimension & Weight		320 × 340 × h125 mm, 3.8 kg	
Packing & Gross Weight		370 × 440 × h210 mm, 4.6 kg	
DC Power & AC Adapter		with Rechargeable Battery & AC 220V Adapter	
Cat. No.		DH.Bal8041	DH.Bal8042
Price, Each. ₩			

DAIHAN® [d] 5g/10g, max.60kg/150kg High Capacity Multi-func. Digital Platform Scale “Bab60” & “Bab150”
With Pcs. · Alarm · Back Light · Rechargeable Battery & AC Adapter, 대용량 다기능 벤치 바란스

“Ext-CAL”
[d] 5g, max.60kg



1-Year Warranty

Platform Scale, “Bab60”

- Made in Korea
- CE Certified
- 1-Year Warranty
- Digital : 6 Digits, LCD-display, 24mm Digits
- Sturdy Ergonomic Design
- Easy Operation and Multi Function : Pcs. Count, Weighing Alarm, Weight Storage/Plus/Call, and Auto-TARE

- * Integrated Rechargeable Battery & Back Light
- * Very Fast Stabilization Time : 1 Sec.
- * Permissible Ambient Temp. -10℃~ +40℃
- * Automatic External Calibration
- * Material : Stainless-steel Platform, ABS Resin Indicator
- * with AC 220V Adapter for DC Power 9V/800mA

Specifications & Ordering information

Spec.	Model	“Bab60”	“Bab150”
Weighing Range		max.60kg	max.150kg
Read-Out [d]. g		5 g	10 g
Reproducibility. g		5 g	10 g
Linearity. g		5 g	10 g
Weighing Plate. mm		420 × 520 mm	
Dimension & Weight		425 × 675 × h755 mm, 14 kg	
Packing & Gross Weight		580 × 710 × h820 mm, 15.9 kg	
DC Power & AC Adapter		with Rechargeable Battery & AC 220V Adapter	
Cat. No.		DH.Bal8045	DH.Bal8046
Price, Each. ₩			

“InBalance™ 200” Portable & Foldable Smart Body Composition Analyzer, Fluid-/Muscle-/Fat-mass measured with 2 Frequency
 Can be Connected to any Smart Phone or Tablet with Bluetooth Connection, Internet Connection with Wi-Fi, Web & Mobile service with Cloud
 접이식 스마트 체성분분석기, 체수분/체지방/근육량 측정, BMI/체지방율/비만도 판정, 스마트폰 또는 태블릿과 사용(별도구매)



(1) “InBalance™ 200” Smart Body Composition Analyzer, without Smart Phone or Tablet

※ **Note!** You Can Use Own Smart Phone or Tablet Downloading “InBalance” App.



(2) “InBalance™ 200” Smart Body Composition Analyzer, with Tablet

- **Made in Korea**
- **It is Connected to any Smart Phone or Tablet with Bluetooth Connection :**
 User’s Own Smart Phone or Tablet could be used with InBalance App, which is Available in Apple App Store and Google Play Store.
- **Measuring 20 Bio-impedance Using 2 Frequency (50kHz, 250kHz)**
- **Tetrapolar 8 Point Tactile Bio-impedance Method**
- **Overall Obesity Diagnosis using BMI & Body Fat Mass Ratio**
- **Waist-hip Ratio & Visceral Fat Area Analysis**
- **Segmental Analysis for Fat & Muscle**
- **Offers Precise Analysis of Body Compositions in Consideration of Individual Weight, Height, Gender, Age, and Diagnose Obesity.**
- **Tetrapolar 8-point Tactile BIA Method : 4 each Tactile Points in Hands and Feet, and 2 Frequencies provide more Precise Analytic Results.**
- **Providing all the Information through mobile App & Web service with Cloud**
- **Conveniences for Both of User and Admin :**
 - Intuitive UI for Self measurement - Offering overall Data for easy Understanding
 - Measured data Management by User Registration
 - Offering Web Program for Membership Management, for Administrator in Hospitals or for Trainers in the Gym (Optional)

Specifications & Ordering information

Spec.	Model	“InBalance™ 200” Portable & Foldable
Material Measuring Method		Multi Frequency, Segmental Bioelectrical Impedance Analysis using 2 different Frequency(50kHz, 250kHz) to measure 20 Impedances of 5 Body Segments (trunk, left arm, right arm, left leg, right leg)
Electrode		Tetrapolar 8-point tactile electrodes
Measuring Items		Body Water (Intra-Cellular Fluid, Extra-Cellular Fluid), Mineral, Protein, Body Fat Mass, Fat Free Mass, Weight, Muscle Mass, Skeletal Muscle Mass, Segmental Muscle Mass, BMI(Body Mass Index), Percent Body Fat, Obesity Degree, Waist-Hip Ratio, Visceral Fat Area, Figure type, Body Ratio, Basal Metabolic Rate, Recommended Weight Control, Recommended Fat Control, 1 Day Required/ Recommended Calories, Overall Score, Abdomen Diagnosis, Measuring History, Impedances for each frequency.
Measuring Scope		10 ~ 250kg, 5 ~ 99 year old
Measuring time		Within 10 seconds
Information Service		Mobile App for iOS & Android, Web service (InBalance.co.kr)
Display		Links to tablet (Can be connected to any Smart Phone or Tablet)
Data Storage		Off-line : 100,000 times (built-in memory) On-line : unlimited (cloud)
Interface		USB 1 Port, Bluetooth
Dimension(w×d×h) & Weight		490×380×970mm, 10.3kg
Power		100~240V, 50/60Hz, Current : 500μA
(1) Cat. No. (Only Analyzer)		DH.HBC10200
Price, Each. ₩		
(2) Cat. No. (with Tablet Package-set)		DH.HBC10201
Price, Each. ₩		

* Other Specifications are available upon Customer’s Request.



Conveniences for User

: It needs to be connected to any Smart Phone or Tablet



App & Web Service

Registered user can access the recorded measuring data anywhere, anytime.

“InBalance™ 300” Smart Body Composition Analyzer, Fluid-/Muscle-/Fast-mass measured with 4 Frequency
 BMI/Body Fat Percentage/Obesity Degree available, 10.1” LCD, Internet Connection with Wi-Fi, Web & Mobile service with Cloud
 스마트 체성분분석기, 체수분/체지방/근육량 측정, BMI/체지방률/비만도 판정, 5~250kHz 4개 주파수 사용



“InBalance™ 300” Smart Body Composition Analyzer

- Made in Korea
- It is Connected to any Smart Phone or Tablet with Bluetooth Connection : User's Own Smart Phone or Tablet could be used with InBalance App, which is Available in Apple App Store and Google Play Store.
- Measuring 20 bio-impedance Using 4 Frequency (5, 50, 100, 250kHz)
- Tetrapolar 8 point Tactile Bio-impedance Method
- Overall Obesity Diagnosis using BMI & Body Fat Mass Ratio
- Waist-hip Ratio & Visceral Fat area Analysis
- Segmental Analysis for Fat & Muscle
- Offers precise Analysis of Body Compositions in Consideration of Individual Weight, Height, Gender, Age, and Diagnose Obesity.
- Result Display on 10.1” Wide Screen LCD for User Convenience
- Observation of Changing trend of Physical Status by Accumulated Data
- Internet Connection via LAN or Wi-Fi
- Providing all the Information through Mobile App & Web service with Cloud
- SMART Healthcare Platform based Design : capable of Connection with other Devices or Service

Specifications & Ordering information

Spec.	Model	“InBalance™ 300” Smart Body Composition Analyzer
Material Measuring Method		Biological Impedance Analysis with 5, 50, 100, 250 kHz 5 Body parts / 20 Segmental Impedance Values
Electrode		Tetrapolar 8-point Tactile Touch
Measuring Items		Body Water, Intra-Cellular Fluid, Extra-Cellular Fluid, Mineral, Protein, Body Fat Mass, Fat-free Mass, Weight, Muscle Mass, Skeletal Muscle Mass, BMI, Body Fat Percentage, Obesity Degree, Waist-hip Ratio, Visceral Fat Area
Additional Information		Impedances by each different Frequency, Dietary Guide
Measuring Scope		10 ~ 250kg, 5 ~ 149 year old
Measuring time		Within 70 seconds
Information Service		Mobile App for iOS & Android, Web service (InBalance.co.kr)
Display		1280 × 800 Resolution, 10.1” IPS Panel with capacitive touch
Data Storage		Off-line : 100,000 times using (built-in memory) On-line : unlimited (cloud)
OS		Android
Interface		LAN, Wi-Fi, 4 × USB, 2 × RS232C
Dimension(w × d × h) & Weight		640 × 450 × 1040mm, 30kg
Power		100~240V, 50/60Hz 35VA, Current : 500μA
Cat. No.		DH.HBC10020
Price, Each. ₩		

• Other Specifications are available upon Customer's Request.



Analysis Result - Print



Analysis Result - Display

DAIHAN® [d] 1mg, max.110g High-performance Moisture Analyzer "WBA-110M", 0.00~ 100.00 %, 40~199℃
 With 100g Cali. Weight, Back Light LCD, Counting Func., 3 × displays of %(g) / °C / Time, & Ext-CAL Program, 초정밀 / 다용도 수분측정기



- CE Certified
- PL(Product Liability) Insurance
- The Percentage of moisture Content
- with Certificate & Traceability : Controlled by Serial Number, Certificate, Delivery-information, and Traceable Data Base System
- Included 100g Calibration Weight
- Store Historical Setting
- Halogen Light Heating
- Stainless-steel Chamber
- Temperature and Time can be Set
- External Calibration
- The Percentage of Dry Residual
- Back Light LCD
- Display after Drying : Moisture(%) - Moisture Content from Wet Weight
Dry Content(%) - Dry Weight from Wet Weight
ATRO(%) - 100 ~ 999%

- * Digital Function, and AC 220V, 50/60Hz Operated
- * Ambient Temperature 5.0~35℃
- * Loadcell Sensor
- * Default and Auto Lock Present Working Mode
- * Built in RS232C & USB port for Printer
- * Included 10 Sample Plate

Specifications & Ordering information

Spec.	Model	"WBA-110M"
Weighing Range. g		max.110 g
Weighing Plate. mm		φ 90 mm
Read-Out [d]. g		1 mg
Reproducibility. g		1 mg
Ambient Temperature		5.0~35℃
Heat Source / Temp. Sensor		Halogen Lamp / PT100 Sensor
Temp. Range / Resolution		40 ~ 199 °C / 1 °C
Moisture Range / Read ability		0.00 ~ 100% / 0.01%
Dry Residual		Range : 0.00 ~ 100.00%, Readability : 0.01%
ATRO		100 ~ 999%, 0 ~ 999%
Timer / Auto-stop		1 ~ 99min(Resolution : 1Sec.) / Auto-stop 0.1~9.9% within 1min.
Number of Storage		15
Calibration		External Calibration, Included 100g Calibration Weight
Display		Digital LCD with Back-Light Function
Power Consumption		400 W
Dimension & Net Weight		180×200×h380 mm / 5.8 kg
Packing Size & Gross Weight		290×305×h440 mm / 6.4 kg
Power Supply & Cord Plug		AC 220V, 50 / 60Hz
Cat. No.		DH.WBA110M
Price, Each. ₩		



(1) 10 Sample Plate (Included)



(2) RS-232C Thermal Printer, "WBA-100"



(3) RS-232C Thermal Label Printer, "WBA-420"

Optional Sample Plate

DH.WBA0005 (1) Sample Plate, φ 90 mm × h4mm

Pk.	Price, ₩
10ea	

Optional Thermal Printer

* Model Name Required for Printer Installaion

- SL.WBA.100P (2) Thermal Printer, Paper Roll, "WBA-100"
Included Cable Module, 1 × Paper Roll
- DH.WBA0084 Thermal Paper Package, 5 × Paper Roll, for "WBA-100"
- SL.WBA.420P (3) Thermal Printer, Label Paper Roll, "WBA-420"
Included Cable Module, 1 × Label Paper Roll
- DH.WBA0771 Thermal Label Paper Package, 5 × Label Paper Roll, for "WBA-420"

Ea.	Price, ₩



Kartell® PP Universal Use Weighing Bottle, Transparent, 20~360ml

Excellent Chemical resistance, Autoclavable, -10°C~+125/140°C, PP **다용도 평량병/샘플병**

■ **Supplied by Kartell® in Italy** * PP(Polypropylene), -10°C +140°C Heat-resistant, Autoclavable

(1) Short form, 20~50ml

	Ea. Price, ₩	Pk. Price, ₩
KA.342 20ml, φ40×h30mm		10ea
KA.345 30ml, φ50×h30mm		10ea
KA.346 50ml, φ60×h34mm		10ea

(2) Tall form, 23~360ml

	Ea. Price, ₩	Pk. Price, ₩
KA.340 23ml, φ30×h50mm		10ea
KA.343 60ml, φ40×h70mm		10ea
KA.347 190ml, φ60×h90mm		10ea
KA.348 360ml, φ70×h120mm		10ea



Glassco® Glass Universal Use Weighing Bottle, Short- & Tall-form, 7~65ml **NEW**

Excellent Chemical/Mechanical Resistance, with Ground Glass Stopper, **글라스 다용도 평량병/샘플병**

■ **Supplied by SciLab Korea**

■ **Complies ASTM 438 Type 1 Borosilicate Glass 3.3**

(1) Short form, 22~55ml

	Ea. ₩	Pk. Price, ₩
GL.264.202.01 22ml, φ40×h30mm		10ea
GL.264.202.03 37ml, φ50×h35mm		10ea
GL.264.202.04 55ml, φ50×h50mm		10ea

(2) Tall form, 7~65ml

	Ea. ₩	Pk. Price, ₩
GL.264.202.06 7ml, φ20×h40mm		10ea
GL.264.202.07 17ml, φ25×h50mm		10ea
GL.264.202.08 28ml, φ30×h60mm		10ea
GL.264.202.09 65ml, φ40×h80mm		10ea



Kern® Reusable Aluminum Weighing Dish, φ90mm, **알루미늄 평량 디쉬**, 수분측정에 적합

■ **Supplied by Kern® in Germany**

* Good for General Weighing, Sampling, Testing and Moisture Drying Application for Moisture Analyzer

KE.MLB.A01 Al.Sample Dish, φ90mm, 80pcs/Pk.

Pk.	Price, ₩
80ea	



Wheaton® Micro-weighing Dish, Reusable Aluminum, 0.5 & 2.2ml, **알루미늄 미량 디쉬**

■ **Supplied by Wheaton® in USA** * For Analytical Balance, φ11 & 20mm

WH.370790 Weighing Dish, 0.5ml, φ11×h6mm, 0.15g/pcs
WH.370792 , 2.2ml, φ20×h8mm, 0.45g/pcs

dh pk. Price, ₩	Cs.	Price, ₩
10ea	1000ea	
10ea	1000ea	



Disposable Aluminum Weighing Dish, 23~67ml, **일회용 알루미늄 디쉬**, 손잡이부

■ **Supplied by LMS® in Japan** * with Finger-grip Handle

AS5.075.05 Dish, Al.23ml, φ51/45×h12mm
AS5.075.06 , Al.38ml, φ60/53×h15mm
AS5.075.07 , Al.67ml, φ77/71×h16mm

Pk.	Price, ₩
100ea	
100ea	
100ea	



Disposable PS Anti-Static Weighing Dish, 9~355ml, **일회용 PS 평량디쉬**, 정전기방지용

■ **Supplied by Simport® in Canada** * Use : Sampling for Liquid and Solid and Powder, Easily Transformed into Funnel-form

* Made of Polystyrene, -10°C~+70/80°C * Anti-static : Suitable for Clean Room Dish in Electronic / Semiconductor Field

(1) Square-type

SP.D250.1 Dish, Square type, 10ml, 40×40×h8mm
SP.D250.2 , 100ml, 78×78×h25mm
SP.D250.3 , 330ml, 127×127×h25mm

Pk.	Price, ₩	Cs.	Price, ₩
500ea		8pk	
500ea			
500ea			

(2) Boat-type, Pour Dish

SP.D251.1 Dish, Boat type, 12ml, 50×37×h8mm
SP.D251.2 , 140ml, 128×76×h25mm
SP.D251.3 , 270ml, 180×117×h25mm

Pk.	Price, ₩	Cs.	Price, ₩
250ea		8pk	
250ea			
250ea			

(3) Hexagonal-type

SP.D252.1 Dish, Hexagonal type, 9ml, Top i.d. 35mm, Base i.d.25mm
SP.D252.2 , 58ml, Top i.d. 70mm, Base i.d.47mm
SP.D252.3 , 203ml, Top i.d.115mm, Base i.d.85mm
SP.D252.4 , 355ml, Top i.d.130mm, Base i.d.95mm

Pk.	Price, ₩	Cs.	Price, ₩
500ea		8pk	
500ea			
500ea			
500ea			





Kartell® Disposable PS Black Weighing Dish, 5~100ml, 일회용 PS 평량디쉬, 흰색시료용

■ **Supplied by Kartell® in Italy** * Made of Polystyrene, -10℃~+70/80℃

KA.11100.09 Dish, Diamond-type, Black, 5ml, 55×31×h5mm
 KA.11101.09, 30ml, 85×56×h15mm
 KA.11102.09, 100ml, 135×96×h19mm

Pk.	Price, ₩	Cs.	Price, ₩
250ea		4pk	
250ea		2pk	
250ea			



Low-Nitrogen Weighing Paper, 평량지 / 유산지

■ **Made in Korea** * Perfect Surface Treatment : Powder Samples were not Asked
 * Ideal for Chemical, Medical, Laboratory * No Dust / Absorptiveness

DH.WEP001 Weighing Paper, 80×80mm
 DH.WEP002, 100×100mm
 DH.WEP003, 150×150mm

Pk.	Price, ₩
500sheet	
500sheet	
500sheet	



Lab Bristle Brush, For Cleaning Balance, Wood Handle with Metal Ferrule, 랩 브러쉬

■ **Made in Korea**

S24.178.2 Brush, Bristle ϕ 19×L52 mm, overall 28cm
 S24.178.3, Bristle ϕ 24×L56 mm, overall 30cm

Ea.	Price, ₩



(1) BC.1740

**Stainless-steel Weighing Forcep, with Plastic Tip, Finished Surface, MP 1,400℃, L 100mm
 Ideal for Handling Precision Weight, Non-Magnetic 18/10 Stainless-steel, 비자성스텐 웨이핑포셉**

(1) **Bochem® Hi-grade Forcep/Germany**

BC.1740 Forcep, L100mm

Ea. Price, ₩

(2) **Forcep/SciLab Korea**

SL.For7089 Forcep, L100mm

Ea. Price, ₩



Micro Spoon-Spatula, Bowl 3×5~5×9, L150~200mm, 마이크로 스패츨러-스푼

■ **Supplied by SciLab Korea** * Made of Non-magnetic 18/10 Stainless-steel, Rustless

SL.Spa7011 Micro Spoon-Spatula, L150, Bowl-3×5, Blade-5×50, Stem- ϕ 2.5 mm
 SL.Spa7012, L150, -5×7, -5×50, - ϕ 2.5 mm
 SL.Spa7013, L180, -5×9, -5×50, - ϕ 2.5 mm
 SL.Spa7014, L200, -5×9, -5×50, - ϕ 2.5 mm

Ea.	Price, ₩



Hammacher® Hi-grade Stainless-steel Spoon-Spatulas, L150~230mm, 스패츨러-스푼

■ **Made in Germany** * Made of "Rostfrei" 18/8 Stainless-steel, Rustless, 1400℃

HA.HSN133.15 Spoon-Spatula, L150, Blade - 10×50, Spoon - 17×38, Stem- ϕ 3mm
 HA.HSN134.18, L180, - 10×55, - 17×38, - ϕ 3mm
 HA.HSN135.21, L210, - 10×60, - 17×38, - ϕ 3mm
 HA.HSN136.23, L230, - 10×60, - 17×38, - ϕ 4mm

Ea.	Price, ₩



Half-rounded Scoop-Spatula, L130~210mm, 스크프-스패츨러

■ **Supplied by SciLab Korea** * Made of Non-magnetic 18/10 Stainless-steel

SL.Sco7001 Scoop-Spatula, STS, L130, Blade-9×40, Stem- ϕ 3.7mm
 SL.Sco7002, L150, -9×45, - ϕ 3.3mm
 SL.Sco7003, L185, -9×50, - ϕ 3.3mm
 SL.Sco7004, L210, -9×50, - ϕ 3.3mm

Ea.	Price, ₩



(1) Stainless-steel Vibration Spatula

**High-grade Vibro-Scoop with Adjusting Knob, with Plastic-handle, L190/220mm
 Ideal for Handling High Value Materials, Non-Magnetic 18/10 Stainless-steel, 고품질 진동 스크프**

■ **Made in Germany** * Ideal for Use with Balance or Handling High Value Materials
 * Adjustable Sample Offering with the Adjusting Knob

(1) **Bochem® Stainless-steel Vibro-Spatula, with Plastic-handle, L190mm**

BC.3540 Vibro Scoop, STS, L190, Blade -12×50mm

Ea.	Price, ₩

(2) **Hammacher® PTFE-coated Vibro-Spatula, with Plastic-handle, L220mm**

* Teflon-PTFE : Anti-Acid / Alkally / Chemicals/ Corrosion, MP 260℃

HA.HSN462.22 PTFE-coated Vibro Scoop, L220, Blade -7×80mm

Ea.	Price, ₩



(2) PTFE-coated Vibration Spatula

Articles	Cat. No	Description
----------	---------	-------------

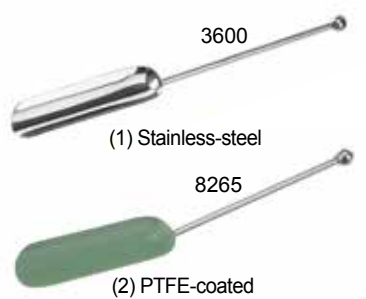

(1) Stainless-steel

(2) PTFE-coated

Bochem® High-grade Weighing Scoop, L 200~250mm, 고품질 비자성 웨이잉 스크프

■ **Made in Germany**

(1) Non-Magnetic 18/10 Stainless-steel, L200~250mm, MP 1,400°C

BC.3600 Weighing-Scoop, STS, L 200, Head-31×70, Stem-φ5 mm, 30g
BC.3602 , L 235, -31×105, -φ5 mm, 35g
BC.3603 , L 250, -31×120, -φ5 mm, 40g

Ea.	Price, ₩

(2) PTFE-Coated, L235mm, MP 260°C

BC.8265 PTFE-coat. Weighing-Scoop, L235, Head-31×105, Stem-φ5 mm, 39g

Ea.	Price, ₩

Stainless-steel Weighing Scoop, L70~250mm, 경제형 웨이잉 스크프

■ **Supplied by SciLab Korea**

* Made of Non Magnetic 18/10 Stainless-steel (STS), Melting-point 1,400°C

(1) Bowl/Dish only, without Handling Stem, L70~120mm

SL.Sco7031 Weighing Scoop, Dish, STS, Dish-32×70mm, 13g
SL.Sco7032 , Dish-32×90mm, 18g
SL.Sco7033 , Dish-32×105mm, 23g
SL.Sco7034 , Dish-32×120mm, 26g

Ea.	Price, ₩

(2) with Handling Stem, L200~250mm

SL.Sco7036 Weighing Scoop, Handled, STS, Bowl-31×70, Overall-L200mm, 29g
SL.Sco7037 , Bowl-31×90, -L220mm, 33g
SL.Sco7038 , Bowl-31×105, -L235mm, 45g
SL.Sco7039 , Bowl-31×120, -L250mm, 48g

Ea.	Price, ₩

Bochem® Aluminium Weighing Scoop, L70~120mm, 알루미늄 웨이잉 스크프, 경량

■ **Made in Germany**

* Light-Weight(Sp. 2.7g/cm³)

BC.12810 Alumi-Weighing Scoop, φ32×L 70mm
BC.12811 , φ32×L 90mm
BC.12812 , φ32×L105mm
BC.12813 , φ32×L120mm

Ea.	Price, ₩

Aluminium Weighing Scoop

Weighing Spoon Set, STS410, 15ml & 5ml, 스텐 평량 스푼세트(대+소)

■ **Supplied by LMS® in Japan**

* Large(15ml×165mm)+Small(5ml×135mm)

AS5.5664.01 Weighing Spoon Set, STS410, 15ml / 5ml, L165mm / L135mm

Set.	Price, ₩
2ea	

Glass Weighing Scoop, 3·6·10ml, Easy to Use, Boro-glass 3.3, Glass 평량 스크프

■ **Supplied by SciLab Korea**

* with open Tubular Arm for the Filling of Powder into Narrow Mouth Bottles/Vessels

* with Flat Bottom for Safety Location

SL.Sco1011 Weighing Scoop, Glass, 3ml, L(approx)-65mm
SL.Sco1012 , 6ml, -80mm
SL.Sco1013 , 10ml, -95mm

Ea.	Price, ₩	Pk.	Price, ₩
		10ea	
		10ea	
		10ea	

VITLAB® PP Colored Measuring Scoop, Flat-top, Autoclavable, 2~1,000ml

For Liquid/Powder/Solid, 0°C~+125/140°C withstand, PP 칼라 계량 스크프, 액체/고체겸용

■ **Made in Germany**

* 121°C Autoclavable PP(Polypropylene), Good Chemical & Temp-Resistance

* Multi-Use : Free-Standing and Flat-Top Construction for Liquids/Powders/Solids Also suitable as Weighing scoops.

* Easily Readable Volume Quantities on the Upper Side of the Handle.

(1) White 2~1000ml

VI.	Volume	Length	Ea. ₩	Cs. Price, ₩
VI.391.94	2ml	L60mm		12ea
VI.392.94	5ml	L82mm		12ea
VI.393.94	10ml	L100mm		12ea
VI.394.94	25ml	L135mm		12ea
VI.395.94	50ml	L160mm		12ea
VI.396.94	100ml	L200mm		12ea
VI.397.94	250ml	L260mm		6ea
VI.398.94	500ml	L315mm		6ea
VI.399.94	1,000ml	L385mm		6ea

(2) Colored 100ml

VI.	Volume	Color	Ea. ₩	Cs. Price, ₩
* L200mm				
VI.3969.43	100ml	Gray		12ea
VI.3969.52		Green		12ea
VI.3969.40		Red		12ea
VI.3969.46		Yellow		12ea



(1) White PP 2~1000ml



(2) Colored PP 100ml

Bath & Bath Circulator

Bath , Basic-type, 100°C	P.27
, 250°C	P.28
, Cold Trap	P.29
, Extraction Water Bath	P.30
, Shaking Water Bath	P.31
, Viscosity	P.32
Bath Circulator , Circulation Water Bath	P.33
, High-Temp. Bath Circulator	P.34
, Refrigerated / Heating Bath Circulator	P.35~36
Accessory , Transfer Fluid & Circulation Hose	P.37



Basic-type Bath
“WB” 6 · 11 · 22 Lit, 100°C



Shaking Water Bath
“MaXturdy™” 18 · 30 · 45 Lit, 100°C



Circulation Water Bath
“WCB” 6 · 11 · 22 Lit, 100°C



Refrigerated / Heating Bath Circulator
“MaXircu™ CL” 8 · 12 · 22 · 30 Lit, -35 ~ +150°C

DAIHAN® Digital General Purpose Water Bath “WB”, 6 · 11 · 22 Lit, up to 100 °C, ±0.1 °C
 With Digital Fuzzy Control System, Stainless-steel Flat Lid, and Back Light LCD, with Certi. & Traceability
 정밀 범용 항온수조, 디지털 퍼지 제어 시스템, 스텐리스 스틸 리드 포함



Digital Precise Water Bath, 11Lit, “WB-11”

- Made in Korea
- CE Certified
- PL(Product Liability) Insurance
- with Certificate & Traceability : Controlled by Serial Number, Certificate, Delivery-information, and Traceable Data Base System
- Digital Fuzzy Control System Implementing Superior Temperature Accuracy
- Patented Jog-Shuttle Control System and Digital LCD with Back-Light Function
- * User's Self-Compensation Function to Control Difference between Real Temperature and Indicated Temperature (±10.0°C).
- * 304 Stainless-steel Bath & Lid for Superior Durability & High Thermal Efficiency/Constant.
- * Digital Timer Function(99hr 59min) : 'Delay Time' and 'Operation Time' can be Controlled.
- * Storage Function for the Set Values of Temperature and Timer.
- * Locking Mode Supported for Experimental Safety (Input to Jog-Shuttle can be Disabled).

Specifications & Ordering information

Spec.	Model	“WB-6” Max. Capa. 6Lit	“WB-11” Max. Capa. 11Lit	“WB-22” Max. Capa. 22Lit
Capacity		6 Lit	11 Lit	22 Lit
Temp. Range & Accuracy		Room Temp. +5°C ~ 100°C, ±0.1°C		
Temp. Resolution		0.1°C-Display, 0.1°C-Control		
Temp. Uniformity & Probe		±1.0°C, PT100		
Heating Power		800 W	1 kW	2 kW
Timer & Alarm		99hr 59min (Delay & Continuous run), Error status & Timer-end		
Display		Digital LCD with Back-Light Function		
Controller		Digital Fuzzy Controller with Jog - Shuttle Switch (Turn + Push)		
Safety Circuit		Over-Temp. / -Current protection, Sensor Error Detection		
Material		Stainless-steel (# 304)-Internal, Powder Coated steel-External		
Lid		included Stainless-steel Flat Lid, Optional Dome Lid		
Drain Valve		None		Mounted(φ9.5~11mm)
Dimension (w×d×h)	Effective Space	300×155×h110mm	302×240×h110mm	500×295×h110mm
	Internal	300×155×h150mm	302×240×h150mm	500×295×h150mm
	External	325×180×h260mm	325×265×h260mm	535×330×h260mm
Packing Size (mm) and Gross Weight (kg)		350×210×h310mm, 8 kg	350×300×h310mm, 10 kg	570×360×h310mm, 14 kg
Electrical Reqts.		1 Phase, AC 120V, 60Hz or AC 230V, 50 / 60Hz		
Cat. No.	230V	DH.WB000106	DH.WB000111	DH.WB000122
	120V	DH.WB000206	DH.WB000211	DH.WB000222
Price, Each. ₩				

* Other Specifications are available upon Customer's Request.



(1) Flat Lid, Stainless-steel (Included)

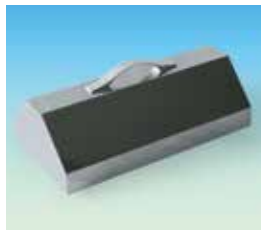

(2) Dome Lid, Stainless-steel



(3) “BFC106” Lid with Concentric Ring Cover Sets for 6Lit



(4) “BFC111” Lid with Concentric Ring Cover Sets for 11Lit



(5) “BFC122” Lid with Concentric Ring Cover Sets for 22Lit Bath



(6) Test Tube Rack, Stainless-steel

Optional Lid and Tube Rack, Stainless-steel

- DH.WB010206 (2) Dome Lid, for 6 Lit, 324 × 176 × h100mm, “BD206”
- DH.WB010211 , for 11 Lit, 324 × 263 × h100mm, “BD211”
- DH.WB010222 , for 22 Lit, 533 × 328 × h100mm, “BD222”
- DH.WB030106 (3) Lid with 2 × Concentric Ring Cover Sets, for 6 Lit, Stainless-steel, 330 × 182 × h20mm, “BFC106”
- DH.WB030111 (4) Lid with 2 × Concentric Ring Cover Sets, for 11 Lit, Stainless-steel, 329 × 269 × h20mm, “BFC111”
- DH.WB030122 (5) Lid with 6 × Concentric Ring Cover Sets, for 22 Lit, Stainless-steel, 539 × 334 × h20mm, “BFC122”
- DH.WB020106 (6) Tube Rack, for 6 Lit, 36Hole × φ 17mm, “BTH106”, Stainless-steel, 220 × 125 × h78.5mm
- DH.WB020206 (6) Tube Rack, for 6 Lit, 15Hole × φ 32mm, “BTH206”, Stainless-steel, 220 × 125 × h78.5mm
- DH.WB020111 (6) Tube Rack, for 11 Lit, 63Hole × φ 17mm, “BTH111”, Stainless-steel, 220 × 205 × h78.5mm
- DH.WB020211 (6) Tube Rack, for 11 Lit, 25Hole × φ 32mm, “BTH211”, Stainless-steel, 220 × 205 × h78.5mm

Ea. Price, ₩

Water Bath with Validation (IQ, OQ) Service

- DH.WB040106 Validation Service(IQ, OQ), with “WB-6” , “BV106”
- DH.WB040111 , with “WB-11”, “BV111”
- DH.WB040122 , with “WB-22”, “BV122”

Ea. Price, ₩

DAIHAN® Digital High Temperature Oil Bath “WHB”, 6 · 11 · 22 Lit, up to 250°C, ± 1.5°C
 With Stainless-steel Flat Lid, Digital Fuzzy Control System, Back Light LCD, with Certi. & Traceability
 정밀 고온 오일 배스, 디지털 퍼지 제어 시스템, 스텐리스 스틸 리드 포함



Digital High Temperature Oil Bath, 11Lit, “WHB-11”



Included Flat Lid, Stainless-steel

- Made in Korea. ■ CE Certified ■ PL(Product Liability) Insurance.
- with Certificate & Traceability : Controlled by Serial Number, Certificate, Delivery-information, and Traceable Data Base System.
- Digital Fuzzy Control System Implementing Superior Temperature Accuracy.
- Patented Jog-Shuttle Control System and Digital LCD with Back-Light Function.
- * Rustless 304 Stainless-steel Bath having 1.2mm & Ceramic Fiber Insulator of 50mm Thickness.
- * User's Self-Compensation Function to Control Difference between Real Temp. and Indicated Temp.
- * Storage Function for the Set Values of Temperature & Timer.
- * Alarm & Digital Timer : 'Delay Time' and 'Operation Time' can be Controlled.
- * Locking Mode Supported for Experimental Safety (Input to Jog-Shuttle can be Disabled).

Specifications & Ordering information

Spec.	Model	“WHB-6” Max. Capa. 6Lit	“WHB-11” Max. Capa. 11Lit	“WHB-22” Max. Capa. 22Lit
Capacity		6 Lit	11 Lit	22 Lit
Temp. Range & Accuracy		Room Temp +5°C to 250°C, ± 1.5°C		
Temp. Uniformity & Probe		± 3.0°C, PT100		
Heating Power		1.5 kW	2.0 kW	2.5 kW
Timer & Alarm		99hr 59min (Delay & Continuous run), Error status & Timer-end		
Display		Digital LCD with Back-Light Function		
Controller		Digital Fuzzy Controller with Jog-Shuttle Switch (Turn+Push)		
Safety Circuit		Over-Temp./-Current protection, Sensor Error Detection		
Material		Stainless-steel (#304)-Internal, Powder Coated steel-External, 50 mm Thickness Ceramic Fiber-Insulation		
Lid		Stainless-steel Flat Lid Included		
Drain Valve		Mounted		
Dimension (w×d×h)	Effective Space	270×180×h110 mm	300×250×h110 mm	400×300×h140 mm
	Mounted	270×180×h150 mm	300×250×h150 mm	400×300×h180 mm
	External	425×305×h340 mm	425×375×h340 mm	525×425×h370 mm
Packing Size (mm) & Gross Weight		470×400×h500 mm, 23 kg	600×490×h500 mm, 25 kg	600×490×h500 mm, 39 kg
Electrical Reqtts.		1 Phase, AC 120V, 60Hz or 230V, 50 / 60Hz		
Cat. No.	230V	DH.WHB00106	DH.WHB00111	DH.WHB00122
	120V	DH.WHB00206	DH.WHB00211	DH.WHB00222
Price, Each. ₩				

* Other Specifications are available upon Customer's Request.

High-Temp. Oil Bath with Validation (IQ, OQ) Service

DH.WHB40106 Validation Service(IQ, OQ), with “WHB-6”, “HBV106”
 DH.WHB40111 , with “WHB-11”, “HBV111”
 DH.WHB40122 , with “WHB-22”, “HBV122”

Ea. Price, ₩

- ※ See page 37 for the Heating Transfer Fluid ;
- ▶ SYN THERM 22L® – 5 + 320°C Heating Transfer Fluid
- ▶ Therminol D12® – 85 + 230°C Cooling/Heating Transfer Fluid

Articles	Cat. No	Description
----------	---------	-------------

DAIHAN® Digital Precision Cold Trap Bath “WCT”, -40 & -80°C, 10 Lit, with Certi. & Traceability
With 2 Glass Cold Trap, Digital PID Control System, Back-Light LCD, CFC-free Refrigeration System, 초저온 동결 트랩



Digital Precision Cold Trap Bath “WCT”



(1) Glass Cold Trap “CTG1000”

※ DAIHAN Recommendation : Combination of the Cold Trap Bath(WCT) with the Vacuum Oven and Vacuum Pump.

- Made in Korea
- CE Certified
- PL (Product Liability) Insurance
- with Certificate & Traceability : Controlled by Serial Number, Certificate, Delivery-information, and Traceable Data Base System
- Digital PID Controller
- CFC-free (R-404A) Refrigeration System
- Patented Jog-Shuttle Control System and Digital LCD with Back-Light Function
- * Ideal for exceptional Cooling System like Collecting Evaporation Vapor or Hazardous Vapor from Vacuum Line.
- * Durable Stainless-steel Bath and Powder Coated steel
- * Digital Timer Function : ‘Delay Time’ and ‘Operation Time’ : Can be Controlled.
- * User’s Self-Compensation Function to Control Difference between Real Temperature and Indicated Temperature.
- * Locking Mode Supported for Experimental Safety (Input to Jog-Shuttle can be Disabled)

Specifications & Ordering information

Spec.	Model	“WCT-40”	“WCT-80”
		Max. Temp. -40°C	Max. Temp. -80°C
Temperature Range		-40°C ~ -20°C	-80°C ~ -65°C
Bath Volume		10 Lit	
Bath Volume & Cold Trap Type		Stainless-steel 304, 2 Glass Trap	
Refrigerator		1/2 HP	1 HP
Power Consumption		900 W	1.8 kW
Refrigerator & Refrigerant		R-404A	HFC
Display		Digital LCD with Back-Light Function	
Controller		PID Controller with Jog-Shuttle Switch (Turn+Push)	
Drain Valve		Mounted	
Safety Circuit		Over Current protection, Sensor Error Detection, Leakage Breaker	
Material		Stainless-steel (#304)-Internal, Powder Coated steel, 1.2t, Doublepaint & Baked-External, 20 mm Thickness Polyurethane-Insulation	
Dimension (w×d×h)		220×220×h210 mm-Internal, 377×453×h705 mm-External	
Cold Trap Inlet Valve Size		od. 10 mm	
Packing Dimension (mm) and Gross Weight (kg)		560×500×h1,010, 67 kg	680×640×h1,130, 90 kg
Electrical Reqts.		1 Phase, AC 120V, 60Hz or 230V, 50 / 60Hz	
Cat. No.	230V	DH.WCT00140	DH.WCT00180
	120V	DH.WCT00240	DH.WCT00280
Price, Each. ₩			

* Other Specifications are available upon Customer’s Request.

※ 운임 약 ₩ 16,000 별도!

Spare Glass Cold Trap

DH.WCT11000

(1) 1× Glass Cold Trap, φ106×h249mm, “CTG1000”, DURAN® Borosilicate Glass α 3.3, Safety-Pressure, Resistant 1.5bar at 250°C, for “WCT”

Ea. Price, ₩

DAIHAN® Extraction Water Bath “WEB”, Multi-purpose, 4 · 6 · 8 Place, with Certi. & Traceability
 With Concentric Ring Cover Sets & Holding Frame, Digital Fuzzy Control, Back Light LCD, up to 100°C, ±0.2°C
 다용도 추출용 항온수조, 4 · 6 · 8 구, 컨센트릭 링 커버 세트 & 홀딩 프레임 포함

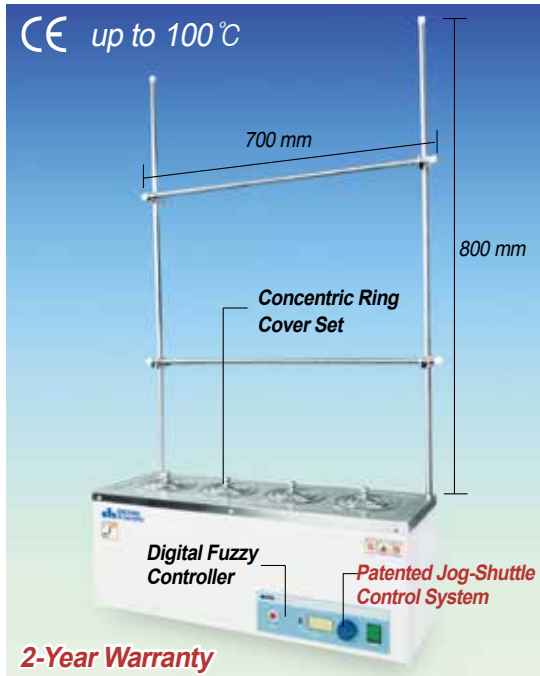

4-Place Extraction Water Bath “WEB-4”

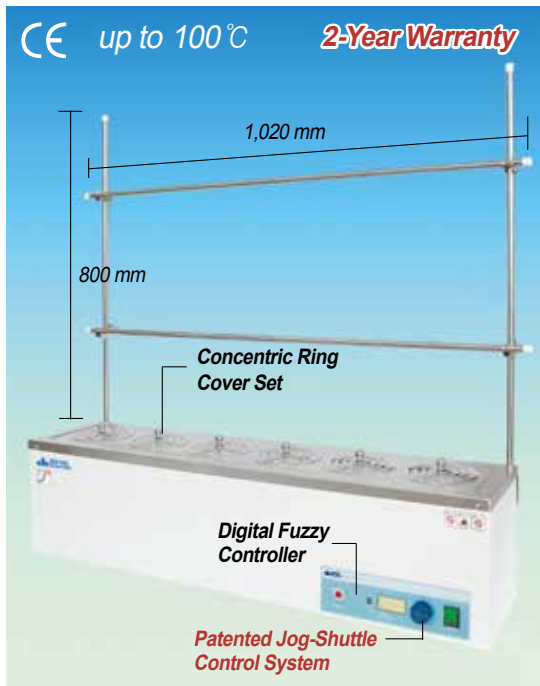

6-Place Extraction Water Bath “WEB-6”



(1) Lid with Concentric Ring Cover Set (Included)

- Made in Korea
- CE Certified
- PL(Product Liability) Insurance
- with Certificate & Traceability : Controlled by Serial Number, Certificate, Delivery-information, and Traceable Data Base System
- Ideal for Gentle Extraction, Soxhlet Extraction and Determination of COD
- Digital Fuzzy Control System Implementing Superior Temperature Accuracy
- Concentric Ring Cover Sets make Effective Steaming Work
- Patented Jog-Shuttle Control System and Digital LCD with Back-Light Function

- * 4 · 6 · 8 Extraction Place are available.
- * Included Concentric Ring Cover Set & Holding Frame
- * User's Self-compensation Function to Control Difference between Real Temperature and Indicated Temperature (± 10.0°C).
- * High Quality 304 Stainless-steel Bath and Holding Frame for Superior Durability.
- * Storage Function for the Set Values of Temperature and Timer.
- * Alarm Function : Error Status and Timer-end.
- * Locking Mode Supported for Experimental Safety (Input to Jog-Shuttle can be Disabled).

Specifications & Ordering information

Spec.	Model	“WEB-4” 4 Place	“WEB-6” 6 Place	“WEB-8” 8 Place
Temp. Range & Accuracy		Room Temp. +5 °C to 100 °C, ±0.2°C		
Temp. Uniformity & Sensor		±1.0°C, PT100		
No. of Extraction Holes		4 Place	6 Place	8(4×2) Place
Heating Power		1.4 kW	1.8 kW	1.4 kW×2
Timer & Alarm		99hr 59min (Delay & Continuous run), Error status & Timer-end		
Display		Digital LCD with Back-Light Function		
Controller		Digital Fuzzy Controller with Jog-Shuttle Switch (Turn+Push)		
Safety Circuit		Over-Temp./-Current protection, Sensor Error Detection, Leakage Breaker		
Material		Stainless-steel (#304)-Internal, Powder Coated steel-External, Stainless-steel Holding Frame		
Flask Capacity		250 ~ 500ml Flask		
Lid		Concentric Ring Cover Set Included		
Top Opening Dia.		φ36 · φ65 · φ96 · φ110mm		
Bath Depth		122mm		
Drain Valve		Mounted		
Dimension (w×d×h)	Internal	610×160×h160 mm	910×140×h160 mm	610×290×h160 mm
	External	680×245×h275 mm	975×245×h275 mm	720×375×h275 mm
Packing Size (mm) and Gross Weight (kg)		1,100×350×h400, 18 kg	1,250×350×h400, 25 kg	900×450×h400, 34 kg
Electrical Reqts.		1 Phase, AC 120V, 60Hz or 230V, 50 / 60Hz		
Cat. No.	230V	DH.WEB01004	DH.WEB01006	DH.WEB01008
	120V	DH.WEB02004	DH.WEB02006	DH.WEB02008
Price, Each. ₩				

* Other Specifications are available upon Customer's Request.

※ 운임 약 ₩ 9,000 별도!

Spare Lid with Concentric Ring Cover Set and Holding Frame Set

- DH.WEB11000 (1) Lid with Concentric Ring Cover Set, “EBC100”, for all “WEB” models
- DH.WEB21004 Holding Frame Set, “EBF100”, for “WEB-4”, 2ea×800mm Pole & 2ea×700mm Pole
- DH.WEB21006 Holding Frame Set, “EBF200”, for “WEB-6”, 2ea×800mm Pole & 2ea×1,020mm Pole
- DH.WEB21008 Holding Frame Set, “EBF300”, for “WEB-8”, 4ea×800mm Pole & 4ea×740mm Pole

Ea. Price, ₩

Articles	Cat. No	Description
----------	---------	-------------

DAIHAN® Digital Precise Shaking Water Bath “MaXturdy™”, Reciprocating Motion, 18 · 30 · 45 Lit
 With Universal Spring Rack, Digital Fuzzy Control, up to 2 Lit Flask, 20~250 rpm, up to 100°C, ±0.1°C, with Certi. & Traceability
 정밀 진탕 항온수조, 왕복 진탕 운동, 디지털 피드백 제어, 고성능 셰이킹 엔진 탑재



Digital Precise Shaking Water Bath
 Max. 30Lit, “MaXturdy™ 30”

- Made in Korea ■ CE Certified ■ PL(Product Liability) Insurance
- with Certificate & Traceability : Controlled by Serial Number, Certificate, Delivery-information, and Traceable Data Base System
- Digital Fuzzy Controller Provides Precise Temperature Control
- Digital Feedback Controller Provides Precise Speed Control
- Hi-Performance Shaking Engine ensures Best Smoothly Shaking Motion and Minimum Noise and Vibration
- Easy to Disassemble Spring Rack for Cleaning
- Patented Shaking Mechanism : Minimum Noise and Vibration
- Patented Jog-Dial Control System and Digital LCD with Back-Light
- * Ideal for Direct Immersion of Samples or Shaking in the Field of Biotechnology and Laboratories.
- * Hybridization Applications, Cell Cultures, Cell Aeration, Increasing Solubility Rates, Molecular Biology Assays, Bacterial Cultures
- * Stainless-steel Bath for Superior Durability & High Thermal Efficiency
- * Universal Stainless-steel Spring Rack Included : for various kind of Flasks and Tubes (up to 2 ℓ)
- * User's Self-Compensation Function to Control Difference between Real Temperature and Indicated Temperature (± 10.0°C)
- * Over Temp., Over Current Protection and Sensor Error Detection
- * Digital Timer Function : 'Delay Time' and 'Operation Time' : Can be Controlled

Specifications & Ordering information

Spec.	Model	“MaXturdy™ 18” Max. Capa. 18Lit	“MaXturdy™ 30” Max. Capa. 30Lit	“MaXturdy™ 45” Max. Capa. 45Lit
Capacity		18 Lit	30 Lit	45 Lit
Max.Q'ty of Erlenmeyer Flask		250 ml×6 ea, 500 ml×4 ea, 1000 ml×1 ea	250 ml×10 ea, 500 ml×8 ea, 1000 ml×3 ea	250 ml×18 ea, 500 ml×15 ea, 1000 ml×8 ea
Temp. Range & Accuracy		Room Temp. +5°C to 100 °C, ±0.1°C		
Temp. Resolution		0.1°C-Display, 0.1°C-Control		
Temp. Uniformity & Probe		±0.5°C , PT100		
Heating Power		1.4 kW	1.8 kW	2.4 kW
Shaking Speed & Resolution		20 ~ 250 rpm, 1rpm-Display/1rpm-Control		
Shaking Stroke (mm)		15, 20, 30 Available (20 as factory Default)		
Timer & Alarm		99hr 59min (Delay & Continuous run), Error status & Timer-end		
Display		Digital LCD with Back-Light Function		
Controller Digital		Fuzzy Controller with Jog-Shuttle Switch (Turn+Push)		
Safety Circuit		Over-Temp./-Current protection, Sensor Error Detection		
Rack		Included Stainless-steel Spring Rack : Universal-type		
Drain Valve		Mounted		
Material		Stainless-steel (# 304)-Internal, Powder Coated steel-External		
Dimension (w×d×h)	Internal (mm)	300×300×h200	500×300×h200	600×380×h200
	External (mm)	563×353×h340	763×353×h340	863×433×h340
Packing Size (mm) & Gross Weight (kg)		620×420×h450, 24 kg	820×420×h450, 26 kg	920×500×h450, 32 kg
Electric Reqts.		1 Phase, AC 120V, 60 Hz or 230V, 50 / 60Hz		
Cat. No.	230V	DH.WSB03018	DH.WSB03030	DH.WSB03045
	120V	DH.WSB03218	DH.WSB03230	DH.WSB03245
Price, Each. ₩				

* Other Specifications are available upon Customer's Request. ※ 운임 약 ₩ 16,000 별도!

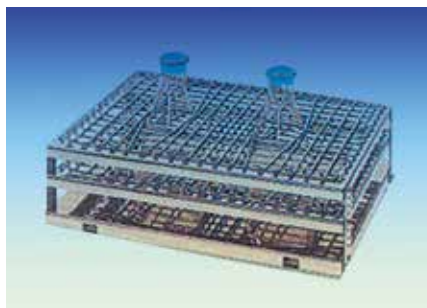

(1) Universal Spring Rack (Included)

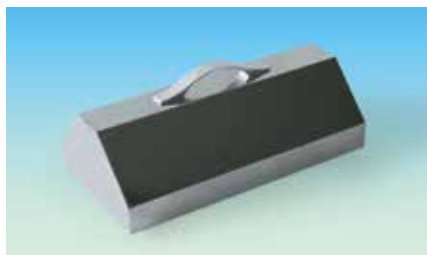

(2) Dome Lid, Stainless-steel (Optional)

Spare Universal Spring Rack

	Ea. Price, ₩
DH.WSB51018 (1) Spring Rack, for 18 Lit, 245×270×h110mm, “SBR018”	
DH.WSB51030 , for 30 Lit, 445×270×h110mm, “SBR030”	
DH.WSB51045 , for 45 Lit, 545×350×h110mm, “SBR045”	

Optional Stainless-steel Dome Lid

	Ea. Price, ₩
DH.WSB02018 (2) Dome Lid, for 18 Lit, 363×353×h69mm, “SBD018”	
DH.WSB02030 , for 30 Lit, 563×353×h69mm, “SBD030”	
DH.WSB02045 , for 45 Lit, 663×433×h69mm, “SBD045”	

Shaking Water Bath with Validation (IQ, OQ) Service

	Ea. Price, ₩
DH.WSB31018 Validation Service(IQ, OQ), with “MaXturdy 18”, “SBV018”	
DH.WSB31030 , with “MaXturdy 30”, “SBV030”	
DH.WSB31045 , with “MaXturdy 45”, “SBV045”	

DAIHAN® Digital Precise Viscosity Bath “WVB”, Useful 5 × Viscometer, Max. 30Lit/min, up to 100 °C, ±0.1 °C
 With 5 Holes Stainless-steel Lid for Viscometer Holder, Available Reverse & Routine-type Viscometer, Transparent Window
 투시형 정밀 점도 항온수조, 5× 점도계 사용가능, 디지털 퍼지 제어 시스템, 5-구 스텐리스 스틸 리드포함



Max. 30Lit/min Viscosity Bath “WVB-30”,
 included Flat Lid for Viscometer Holder
 (without Viscometer Holder)



Flat Lid with Viscometer Holder

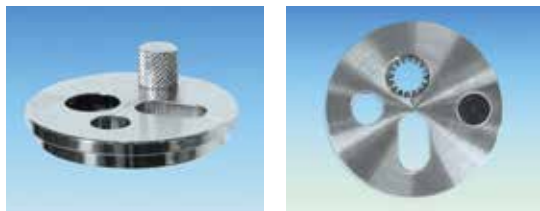

(1) Viscometer Holder “WVB02010” (Optional)

- Made in Korea ■ CE Certified ■ PL(Product Liability) Insurance
- with Certificate & Traceability : Controlled by Serial Number, Certificate, Delivery-information, and Traceable Data Base System
- Used for Precise Measurement with Capillary Viscometers
- Digital Fuzzy Control System Implementing Superior Temperature Accuracy
- Powerful Circulation Pump ensures Highest Uniformity of Temperature
- Viscometer Holder : Available Reverse & Routine-type Viscometer
- Patented Jog-Shuttle Control System and Digital LCD with Back-Light Function.
- * Stainless-steel(#304) made inner bath
- * Stainless-steel Lid Contains Five Holes for Insertion of Viscometer Holders
- * User's Self-compensation Function to Control Difference between Real Temperature and Indicated Temperature
- * Storage Function for the Set Values of Temperature and Time
- * Locking Mode Supported for Experimental Safety (Input to Jog-Shuttle can be Disabled)
- * Included Flat Lid for Viscometer(without Viscometer Holder)
- * Over Temp., Over Current Protection and Sensor Error Detection
- * Digital Timer Function : 'Delay Time' and 'Operation Time' : Can be Controlled

Specifications & Ordering information

Spec.	Model	“WVB-30” Max. Flow 30Lit/min
Range & Accuracy		Room Temp. +5°C to 100 °C, ±0.1°C
Temp. Resolution		0.1°C-Display, 0.1°C-Control
Temp. Uniformity & Probe		±0.2°C , PT100
Heating Power		2 kW
Pump		Magnetic Drive, Max. Flow 30 Lit/min
Timer & Alarm		99hr 59min (Delay & Continuous run), Error status & Timer-end
Display		Digital LCD with Back-Light Function
Controller		Digital Fuzzy Controller with Jog-Shuttle Switch (Turn+Push)
Safety Circuit		Over-Temp./-Current protection, Sensor Error Detection
Lid		Included 5 Holes Stainless-steel Lid for Viscometer Holder
Drain Valve		Mounted
Viewing Window Size(mm)		230×180
Material		Stainless-steel (# 304)-Internal, Powder Coated steel-External, Vacuum Sealed and Tempered Safety Pair Glasses-Window
Dimension (w×d×h)	Effective Space (mm)	330×300×h260 mm
	Internal (mm)	350×300×h300 mm
	External (mm)	585×375×h420 mm
Packing Size (mm) & Gross Weight (kg)		640×450×h500 mm, 24 kg
Electric Reqts.		1 Phase, AC 120V, 60Hz or 230V, 50 / 60Hz
Cat. No.	230V	DH.WVB01030
	120V	DH.WVB02030
Price, Each. ₩		

* Other Specifications are available upon Customer's Request. ※ 운임 약 ₩ 16,000 별도!

Spare Stainless-steel Flat Lid for Viscometer Holder

DH.WVB11030 Flat Lid, for 30 Lit, w380×d330, 5×φ50mm Holes, “VBF030” | Ea. Price, ₩

Optional Viscometer Holder

DH.WVB02010 (1) Viscometer Holder, “WVB02010” for SI Analytics® Ostwald, Ubbelohde | Ea. Price, ₩

DH.WVB02011 Viscometer Holder, “WVB02011” for SI Analytics® Cannon-Fenske, Witeg® Ubbelohde, Cannon-Fenske

DH.WVB02012 Viscometer Holder, “WVB02012” for Thread-type Ubbelohde

Viscosity Bath Validation (IQ, OQ) Service

DH.WVB31030 Validation Service(IQ, OQ), with “WVB-30”, “VVB030” | Ea. Price, ₩

Articles	Cat. No	Description
----------	---------	-------------

DAIHAN® Digital Precise Circulation Water Bath “WCB”, 6 · 11 · 22 Lit, with Certi. & Traceability
 With Stainless-steel Flat Lid, Powerful Circulation Pump, up to 100°C, ±0.1°C, 5 Lit/min, 정밀 항온 순환 수조



Digital Precise Circulation Water Bath
 Max. 22Lit, “WCB-22”

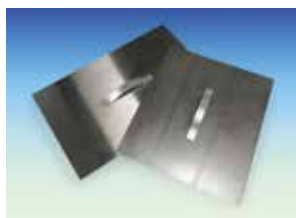

Flat Lid, Stainless-steel
 (Included)

- Made in Korea ■ CE Certified ■ PL (Product Liability) Insurance
- with Certificate & Traceability : Controlled by Serial Number, Certificate, Delivery-information, and Traceable Data Base System
- Digital Fuzzy Control System Implementing Superior Temperature Accuracy
- Patented Jog-Shuttle Control System and Digital LCD with Back-Light Function
- * Ideal for Biotechnology, Clinical, Environmental, Medical, Petroleum, Food Industry, Pharmaceutical and Industrial Applications. * Alarm function : Error Status and Timer-end
- * Warning and Automatic Stop Function in case of Liquid Shortage.
- * Powerful Circulation Pump Assures Temp. Uniformity : Internal and External Circulation.
- * Connection with Evaporators and Viscosimeters is applicable.

Specifications & Ordering information

Spec.	Model	“WCB-6” Max. Capa. 6Lit	“WCB-11” Max. Capa. 11Lit	“WCB-22” Max. Capa. 22Lit
Capacity		6 Lit	11 Lit	22 Lit
Temp. Range & Accuracy		Room Temp. + 5°C ~ 100°C, ±0.1°C		
Temp. Resolution		0.1°C-Display, 0.1°C-Control		
Temp. Uniformity & Probe		±0.2°C, PT100		
Heating Power		800 W	1 kW	2 kW
Pump		5 Lit / min (Internal / External)		
Circulation Nozzle		id.7×od.11 mm (id.9 / od.12mm silicon tube connected for inner circulation)		
Timer & Alarm		99hr 59min (Delay & Continuous run), Error status & Timer-end		
Controller & Display		Digital Fuzzy Controller with Back Light Digital LCD		
Safety Circuit		Over-Temp./-Current protection, Sensor Error & Low Level Detection		
Material		Stainless-steel (# 304)-Internal, Powder Coated steel-External		
Drain Valve		None		Mounted(φ9.5-11mm)
Dimension (w×d×h)	Effective Space	120×155×h150 mm	170×240×h150 mm	372×295×h150 mm
	Internal	300×155×h150 mm	302×240×h150 mm	500×295×h150 mm
	External	330×185×h385 mm	335×275×h385 mm	540×335×h410 mm
Packing Size (mm) and Gross Weight (kg)		350×210×h410mm, 11 kg	360×300×h420mm, 13 kg	580×380×h470mm, 18 kg
Electrical Reqts.		1 Phase, AC 120V, 60Hz or AC 230V, 50 / 60Hz		
Cat. No.	230V	DH.WCB00106	DH.WCB00111	DH.WCB00122
	120V	DH.WCB00206	DH.WCB00211	DH.WCB00222
Price, Each. ₩				

* Other Specifications are available upon Customer's Request.

※ 운임 약 ₩ 9,000 별도!

DAIHAN® Digital Precise Circulation Immersion Pump Head “WCB-H”, 11 & 22 Lit, up to 100°C
 With Digital Fuzzy Control System, Certi. & Traceability, Power Circulation Pump, 5 Lit/min, 정밀 항온 순환기



- Made in Korea ■ CE Certified ■ PL (Product Liability) Insurance
- with Certificate & Traceability : Controlled by Serial Number, Certificate, Delivery-information, and Traceable Data Base System
- Digital Fuzzy Control System Implementing Superior Temperature Accuracy
- Patented Jog-Shuttle Control System and Digital LCD with Back-Light Function
- * Ideal for Biotechnology, Clinical, Environmental, Medical, Petroleum, Food Industry, Pharmaceutical and Industrial Applications. * Alarm function : Error Status and Timer-end
- * Powerful Circulation Pump Assures Temp. Uniformity : Internal and External Circulation.

Specifications & Ordering information

Spec.	Model	“WCB-11H” Max. Capa. 11Lit	“WCB-22H” Max. Capa. 22Lit
Temp. Range & Sensor		Room Temp. + 5°C ~ 100°C, PT100	
Heating Power & Pump		1 kW, 5 Lit/min	2 kW, 5 Lit/min
Timer & Alarm		99hr 59min (Delay & Continuous run), Error status & Timer-end	
Controller & Display		Digital Fuzzy Controller with Back Light Digital LCD	
Safety Circuit		Over-Temp./-Current protector, Sensor Error & Low Level Detection	
Dimension		130×165×h320 mm	
Packing Size (mm) and Gross Weight (kg)		400×280×h200 mm, 8 kg	400×280×h200 mm, 10 kg
Electrical Reqts.		1 Phase, AC 120V, 60Hz or AC 230V, 50 / 60Hz	
Cat. No.	230V	DH.WCB10011	DH.WCB10022
	120V	DH.WCB20011	DH.WCB20022
Price, Each. ₩			



DAIHAN® Precise High-temp Bath Circulator “MaXircu™ CH”, to 250°C, ±0.1°C, 8 · 12 · 22 · 30 Lit
 With Stainless-steel Flat Lid, Digital Fuzzy Control System, Certi. & Traceability, Flow 16 Lit/min, Lift 2.8m
 Ideal for Heating Line of Facility, External Circulating Connect - od.12.5 & id.10.5mm, 정밀 고온 배스겸용 고온 씨클레이터



High Temp. Bath Circulator
 Max. 8Lit, “CH-8” & Max. 12Lit, “CH-12”



External Circulating Nozzle

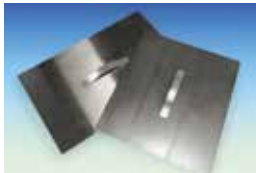

Flat Lid, Included



Ex. Multi-use High Temp. Bath Circulator
 with Modular Reactor System

- Made in Korea. ■ CE Certified ■ PL(Product Liability) Insurance.
- with Certificate & Traceability : Controlled by Serial Number, Certificate, Delivery-information, and Traceable Data Base System.
- Advanced Heating System Ensures Temperature Performance.
- Patented Jog-Dial Control System and Capacitive Touch Button.
- * Digital Fuzzy Control System Implementing Superior Temperature Accuracy.
- * Innovated Powerful Circulation Pump ensures Temp. Uniformity : Internal and External Circulation (Max Flow Rate : 16 Lit/min).
- * Controlled 5 Steps Circulation speed(Flow Rate).
- * 304 Stainless-steel Bath and Lid for Superior Durability and High Thermal Efficiency.
- * Compensation Function to Control Difference between Real Temp. and Indicated Temp.
- * Digital Timer Function : ‘Delay Time’ and ‘Operation Time’ can be Controlled.
- * Locking Mode Supported for Experimental Safety (Input to Jog-Dial can be Disabled).

Specifications & Ordering information

Spec. / Model	MaXircu™ CH-8 Max. Capa. 8 Lit	MaXircu™ CH-12 Max. Capa. 12 Lit	MaXircu™ CH-22 Max. Capa. 22 Lit	MaXircu™ CH-30 Max. Capa. 30 Lit	
Bath Volume	8 Lit	12 Lit	22 Lit	30 Lit	
Pump	Max Flow Rate : 16 Lit/min, (Controlled 5 Steps Flow Rate Speed), Max Pressure : 5 psi, Max Lift : 2.8m				
Temp. Range & Accuracy	Room Temp + 5°C ~ 250°C, ±0.1°C				
Temp. Resolution	0.1°C-Display, 0.5°C-Control				
Temp. Uniformity & Probe	±0.2°C, PT100				
Heating Power	1.0 kW	1.5 kW	2.2 kW	2.5 kW	
Heat-up Time	50 min. to 100°C				
External Circulation Nozzle	id.10.5 / od.12.5 mm				
Timer & Alarm	99hr 59min (Delay & Continuous run), Error status & Timer-end				
Display	Digital LCD with Back-Light Function				
Controller	Digital Fuzzy Controller with Jog - Dial Knob (Turn+Push)				
Safety Circuit	Over-Temp./-Current protection, Sensor Error & Low Level Detection				
Material	Stainless-steel (#304)-Internal, Powder Coated steel-External, 50mm Thickness Ceramic Fiber-Insulation				
Lid & Drain Valve	included Stainless-steel Flat Lid, Ball Valve, Optional Dome Lid,				
Dimension (w×d×h)	Effective Space	180×130×h155	250×130×h155	340×250×h155	340×250×h200
	Mounted	180×320×h155	250×320×h155	340×440×h155	340×440×h200
	External	303×443×h569	373×443×h569	463×563×h569	463×563×h614
Packing Size (mm) & Gross Weight(kg)	400×470×h630 19 kg	400×470×h630 21 kg	490×600×h680 23 kg	490×600×h680 37 kg	
Electrical Reqts.	1 Phase, AC 120V, 60Hz or AC 230V, 50 / 60Hz				
Cat. No.	230V	DH.WCH00408	DH.WCH00412	DH.WCH00422	DH.WCH00430
	120V	DH.WCH00508	DH.WCH00512	DH.WCH00522	DH.WCH00530
Price, Each. ₩					

* Other Specifications are available upon Customer's Request.

※ 운임 약 ₩ 9,000 별도!

※ See page 37 for the Cooling/Heating Transfer Fluid & Circulation Hose ;

▶ Therminol D12® – 85+230°C Cooling/Heating Transfer Fluid

▶ SYN THERM 22L® – 5+320°C Heating Transfer Fluid

▶ Insulated External Circulating Tubing

※ Note : Cooling Transfer Fluid Should be an Antifreezing Solution

DAIHAN® -25+150°C Digital Precise Refrigerated/Heating Bath Circulator "MaXircu™ CR", ±0.2°C
 With Flat Lid, Digital Fuzzy Control, CFC-free Refrigeration, Certi. & Traceability, 8 · 12 · 22 · 30 Lit, Flow 25Lit/min, Lift 4m
 Ideal for Cooling/Heating Line of Facility, External/Internal Circulating Connect - od.12 & id.10mm, 정밀 냉동/가열 배스 겸용 써클레이터



2-Year Warranty

-25°C ~ +150°C Refrigerated / Heating Bath Circulator
 Max. 8Lit, "CR-8" & Max. 12Lit, "CR-12"



External Circulation Nozzle

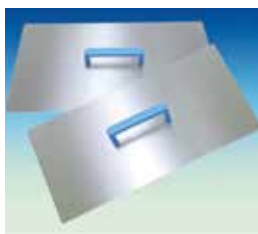

Flat Lid, Stainless-steel (Included)

- Made in Korea
- CE Certified
- PL (Product Liability) Insurance
- with Certificate & Traceability : Controlled by Serial Number, Certificate, Delivery-information, and Traceable Data Base System.
- Advanced Refrigerating System Ensures Temperature Performance.
- Digital Fuzzy Control System Implementing Superior Temperature Accuracy.
- Patented Jog-Dial Control System and Capacitive Touch Button, Digital LCD with Back-Light Function.
- * Innovated Powerful Circulation Pump ensures Temp. Uniformity : Internal and External Circulation (Max Flow Rate : 25 Lit/min).
- * Controlled 5 Steps Circulation speed(Flow Rate).
- * Innovated Refrigeration System, CFC-free (R-404A).
- * External & Internal Circulation : Possible.
- * For Inner Circulating : to Connect directly the In-/outlet Nozzles.
- * RS232C Interface for Remote Monitoring and Controlling with PC.
- * More Faster Cool-down Time. * Urethane Foam Insulation.
- * All models Built in Caster. * Proper Liquid Level Line in Bath.
- * User's Self-compensation Function to Control Difference between Real Temperature and Indicated Temperature (± 10.0°C).
- * Warning and Auto-Stop Function in case of Liquid Shortage.
- * Auto-controlled Refrigeration System for Compressor Protection and Power Saving.
- * Locking Mode Supported for Experimental Safety (Input to Jog-Dial can be Disabled).

Specifications & Ordering information

Spec.	Model	MaXircu™ CR-8	MaXircu™ CR-12	MaXircu™ CR-22	MaXircu™ CR-30
		Max. Capa. 8 Lit	Max. Capa. 12 Lit	Max. Capa. 22 Lit	Max. Capa. 30 Lit
Temp. Range & Accuracy		-25°C ~ +150°C, ±0.1°C			
Temp. Resolution		0.1°C-Display, 0.1°C-Control			
Temp. Uniformity & Probe		±0.2°C at -10°C, PT100			
Pump		Max Flow Rate : 25Lit/min(Controlled 5 Steps Flow Rate Speed), Max Pressure : 7.5 psi, Max Lift : 4m			
Bath Volume		8 Lit	12 Lit	22 Lit	30 Lit
Heating Power		1 kW	1.5 kW	2 kW	2.2 kW
Refrigerator		1/3HP	1/3HP	1/2HP	3/4HP
Cooling Capacity	at +20°C	300 W	380 W	680 W	850 W
	at 0°C	200 W	250 W	500 W	620 W
	at -20°C	110 W	130 W	300 W	400 W
Refrigerant		CFC -Free(R-404A) Refrigeration System			
Total Power Consumption		1.6 kW	2 kW	2.7 kW	3 kW
Compressor Control		Intelligent Control of Refrigerator for preventing Compressor Overload			
Pump		Max Flow Rate : 25Lit/min, Max Pressure : 7.5 psi, Max Lift : 4m			
External Circulation Nozzle		id.10.5 / od.12.5mm(For Inner Circulat. : to Connect directly the in-/outlet Nozzles)			
Timer & Alarm		99hr 59min (Delay & Continuous run), Error status & Timer-end			
Display		Digital LCD with Back-Light Function			
Controller		Digital Fuzzy Controller with Jog-Dial Knob (Turn+Push)			
Safety Circuit		Over-Temp./-Current protection, Sensor Error Detection, Leakage Breaker			
Material		Stainless-steel (# 304)-Internal, Powder Coated steel-External, 40mm Thickness Urethane Foaming - Insulation			
Lid & Drain Valve		included Stainless-steel Flat Lid, Ball Valve, Optional Dome Lid,			
Dimension (w×d×h)	Effective Space (mm)	175×153×150	230×181×150	290×220×200	330×290×200
	Internal (mm)	175×320×150	230×350×150	290×390×200	330×460×200
	External (mm)	330×474×752	400×523×807	483×563×850	494×633×906
Packing Size (mm) & Gross Weight (kg)		420×560×925	530×630×985	615×670×1025	630×740×1075
		45 kg	54 kg	63 kg	70 kg
Electrical Reqts.		1 Phase, AC 120V, 60Hz or AC 230V, 50 / 60Hz			
Cat. No.	230V	DH.WCR00408	DH.WCR00412	DH.WCR00422	DH.WCR00430
	120V	DH.WCR00508	DH.WCR00512	DH.WCR00522	DH.WCR00530
Price, Each. ₩					

* Other Specifications are available upon Customer's Request.

※ 운임 약 ₩ 16,000 별도!

※ See page 37 for the Cooling/Heating Transfer Fluid & Circulation Hose ;

▶ Therminol D12® -85+230°C Cooling/Heating Transfer Fluid

▶ SYN THERM 22L® -5+320°C Heating Transfer Fluid

▶ Insulated External Circulating Tubing

※ Note : Cooling Transfer Fluid Should be an Antifreezing Solution

Refrigerated Circulator with Validation (IQ, OQ) Service

DH.WCR30308	Validation Service(IQ, OQ), with "MaXircu CR-8", "CRBV208"	Ea. Price, ₩
DH.WCR30312	, with "MaXircu CR-12", "CRBV212"	
DH.WCR30322	, with "MaXircu CR-22", "CRBV222"	
DH.WCR30330	, with "MaXircu CR-30", "CRBV230"	

DAIHAN® -35 + 150°C Digital Precise Refrigerated/Heating Bath Circulator "MaXircu™ CL", ±0.2°C
 With Flat Lid, Digital Fuzzy Control, CFC-free, Certi. & Traceability, Capa. 8 · 12 · 22 · 30 Lit, Flow 25Lit/min, Lift 4m
 Ideal for Cooling/Heating Line of Facility, External/Internal Circulating Connect - od.12 & id.10mm, 정밀 냉동/가열 배스 겸용 써클레이터



2-Year Warranty

-35°C ~ +150°C Refrigerated / Heating Bath Circulator
 Max. 8Lit, "CL-8" & Max. 12Lit, "CL-12"



External Circulation
 Nozzle

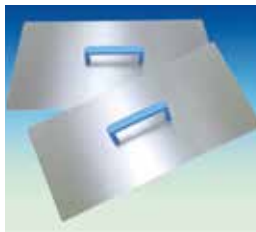

Flat Lid, Stainless-steel
 (Included)

- Made in Korea
- CE Certified
- PL(Product Liability) Insurance
- with Certificate & Traceability : Controlled by Serial Number, Certificate, Delivery-information, and Traceable Data Base System
- Advanced Refrigeration System Ensures Temperature Performance
- Digital Fuzzy Control System Implementing Superior Temperature Accuracy
- Patented Jog-Dial Control System and Capacitive Touch Button, Digital LCD with Back-Light Function.

- * Innovated Powerful Circulation Pump ensures Temp. Uniformity : Internal and External Circulation (Max Flow Rate : 25 Lit/min).
- * Controlled 5 Steps Circulation speed(Flow Rate).
- * Innovated Refrigeration System, CFC-free (R-404A).
- * External & Internal Circulation : Possible
- * For Inner Circulating : to Connect directly the In-/outlet Nozzle.
- * RS232C Interface for Remote Monitoring and Controlling with PC
- * More Faster Cool-down Time
- * Urethane Foam Insulation
- * All models Built in Caster
- * Proper Liquid Level Line in Bath
- * Connection with Evaporator or Viscometer is applicable
- * User's Self-compensation Function to Control Difference between Real Temperature and Indicated Temperature (± 10.0°C).
- * Warning and Auto-Stop Function in case of Liquid Shortage.
- * Auto-controlled Refrigeration System for Compressor Protection and Power Saving.
- * Locking Mode Supported for Experimental Safety (Input to Jog-Dial can be Disabled)

Specifications & Ordering information

Spec.	Model	MaXircu™ CL-8 Max. Capa. 8 Lit	MaXircu™ CL-12 Max. Capa. 12 Lit	MaXircu™ CL-22 Max. Capa. 22 Lit	MaXircu™ CL-30 Max. Capa. 30 Lit
Temp. Range & Accuracy		-35°C ~ +150°C, ±0.1°C			
Temp. Resolution		0.1°C-Display, 0.1°C-Control			
Temp. Uniformity & Probe		±0.2°C at -20°C, PT100			
Pump		Max Flow Rate : 25Lit/min(Controlled 5 Steps Flow Rate Speed), Max Pressure : 7.5 psi, Max Lift : 4m			
Bath Volume		8 Lit	12 Lit	22 Lit	30 Lit
Heating Power		1 kW	1.5 kW	2 kW	2.2 kW
Refrigerator		1/2HP	1/2HP	7/8HP	1HP
Cooling Capacity	at +20°C	500 W	530 W	860 W	1030 W
	at 0°C	340 W	370 W	620 W	760 W
	at -20°C	200 W	210 W	400 W	500 W
Refrigerant		CFC -Free(R-404A) Refrigeration System			
Total Power Consumption		1.7 kW	2.2 kW	3 kW	3.3 kW
Compressor Control		Intelligent Control of Refrigerator for preventing Compressor Overload			
External Circulation Nozzle		id.10.5 / od.12.5mm(For Inner Circulat. : to Connect directly the in-/outlet Nozzles)			
Timer & Alarm		99hr 59min (Delay & Continuous run), Error status & Timer-end			
Display		Digital LCD with Back-Light Function			
Controller		Digital Fuzzy Controller with Jog-Dial Knob (Turn+Push)			
Safety Circuit		Over-Temp./-Current protection, Sensor Error Detection, Leakage Breaker			
Material		Stainless-steel (# 304)-Internal, Powder Coated steel-External, 40 mm Thickness Urethane Foaming - Insulation			
Lid & Drain Valve		included Stainless-steel Flat Lid, Ball Valve, Optional Dome Lid			
Dimension (w×d×h)	Effective Space (mm)	175×153×150	230×181×150	290×220×200	330×290×200
	Internal (mm)	175×320×150	230×350×150	290×390×200	330×460×200
	External (mm)	400×523×807	400×523×807	483×563×850	494×633×906
Packing Size (mm) & Gross Weight (kg)		530×630×985	530×630×985	615×670×1025	630×740×1075
		50 kg	55 kg	65 kg	78 kg
Electrical Reqt.s.		1 Phase, AC 120V, 60Hz or AC 230V, 50 / 60Hz			
Cat. No.	230V	DH.WCL00408	DH.WCL00412	DH.WCL00422	DH.WCL00430
	120V	DH.WCL00508	DH.WCL00512	DH.WCL00522	DH.WCL00530
Price, Each. ₩					

* Other Specifications are available upon Customer's Request.

※ 운임 약 ₩ 16,000 별도!

※ See page 37 for the Cooling/Heating Transfer Fluid & Circulation Hose ;

▶ Therminol D12® - 85 + 230°C Cooling/Heating Transfer Fluid

▶ SYN THERM 22L® - 5 + 320°C Heating Transfer Fluid

▶ Insulated External Circulating Tubing

※ Note : Cooling Transfer Fluid Should be an Antifreezing Solution

Refrigerated Circulator with Validation (IQ, OQ) Service

- DH.WCL30308 Validation Service(IQ, OQ), with "MaXircu CL-8", "CLBV208"
- DH.WCL30312 , with "MaXircu CL-12", "CLBV212"
- DH.WCL30322 , with "MaXircu CL-22", "CLBV222"
- DH.WCL30330 , with "MaXircu CL-30", "CLBV230"

Ea. Price, ₩

Articles	Cat. No	Description
		
<p>Insulated Silicone & Teflon PFA Circulation Hose, Id ϕ 10 ~ 19mm, L1/1.5m</p> <p>■ Supplied by SciLab Korea * ϕ 37mm Black NBR Foam Insulated Silicone or PFA-Hose * Silicone Vacu-Hose : id 10×od 13mm, id 15×od 20mm, id 18×od 24mm, 220℃ * SL.Tub4031 & SL.Tub4032 : PFA Hose * PFA Hose : id 10×od 12mm / PTFE Hose : id 15×od 16mm, id 19×od 21mm, -100 + 260℃</p>		
(1) Insulated Silicone Hose, 220℃	dh Pk. Price, ₩	(2) Insulated PFA Hose, 260℃
SL.Tub4021 Sili-hose, id 10mm, L1m	1m	SL.Tub4031 PFA-hose, id 10mm, L1m
SL.Tub4022 , L1.5m	1.5m	SL.Tub4032 , L1.5m
SL.Tub4023 , id 15mm, L1m	1m	SL.Tub4033 PTFE-hose, id 15mm, L1m
SL.Tub4024 , L1.5m	1.5m	SL.Tub4034 , L1.5m
SL.Tub4025 , id 18mm, L1m	1m	SL.Tub4035 , id 19mm, L1m
SL.Tub4026 , L1.5m	1.5m	SL.Tub4036 , L1.5m
(3) Best Insulatedly & Flexible Stainless-steel Circulation Hose, Id ϕ 17mm, L1m, 360℃		Ea. Price, ₩
SL.Tub7021 Flexible Stainless-steel Circulation Hose, id 17×od 60mm, L1m		

Therminol D12® -85+230℃ Best COOL-/HEAT-ing Transfer Fluid, Synthetic Hydrocarbon Mixture
 for Low/High-Temp Baths, Clearly Harmless Liquid, Low Odor FDA Grade, 4/18/200Lit, 냉매/열매 겸용 합성 탄화수소혼합물(액체)



(1) 4Lit

(2) 18Lit

■ **Supplied by "Eastman" USA** ■ **Clear, Water white Liquid / Non-Toxic / Low-Smell, FDA-Grade.**
 ■ **The Best Circulation Properties / Thermal Stability.**
 ■ **The Lowest Viscosity, cP** ▶ (1) -50℃ : 12cP, (2) 100℃ : 0.46cP, (3) 200℃ : 0.19cP, (4) 230℃ : 0.16cP
 * Specific Gravity : 0.759 at 25℃ * Autoignition Temp : 247℃ * Flash point : 62℃
 * Freezing Point : -94℃ * Boiling Point(90%) : 204℃ * Do not use for Silicone Tube
 * Package : (1) 4Lit and (2) 18Lit PE Square Bottle / Subdivision, Original-200Lit Steel Drum / 155kg

SL.CirD12.1 (1) "Therminol D12" Cool/Heat Transfer Fluid, -85 +230℃, 4 Lit

4ℓ .dh pk	₩
4Lit	

SL.CirD12.2 (2) "Therminol D12" Cool/Heat Transfer Fluid, -85 +230℃, 18 Lit

18ℓ .dh pk	₩
18Lit	

SL.CirD12 "Therminol D12" Cool/Heat Transfer Fluid, -85 +230℃, 200 Lit/Drum

※ **운임 약 ₩ 25,000 별도!**

Drum Price, ₩	
200Lit	



Heating Transfer Fluid, 20Lit

SYN THERM 22L® -5+320℃ Heating Transfer Fluid, Synthetic Alkylbenzene Derivative
 For Low- & High-Temp Circulation, 알킬벤젠계 합성열매 NEW

■ **Made in Korea**
 * Hazards Identification of MSDS(Material Safety Data Sheet) :
 - H315 Causes Skin Irritation - H319 Causes Serious Eye Irritation
 - H335 May Cause Respiratory Irritation - H336 May Cause Drowsiness or Dizziness
 * Kinematic Viscosity & Density :
 (1) at 0℃ : 22.7cSt, 0.885kg/ℓ (2) at 40℃ : 21.80cSt, 0.859kg/ℓ
 (3) at 80℃ : 6.09cSt, 0.834kg/ℓ (4) at 140℃ : 6.09cSt, 0.795kg/ℓ
 (5) at 200℃ : 1.10cSt, 0.756kg/ℓ (6) at 260℃ : 0.74cSt, 0.718kg/ℓ

SL.SYN22L SYN THERM 22L® Heating Transfer Fluid -5 +320℃, 20Lit

Pk. Price, ₩	
20Lit	

DAIHAN® Sample Mixer “BLD-1620”, Lab Stomacher, Digital Controller, Low Noise, for 330 ~ 1,620ml Bags **NEW**
 With ABS Body, Adjustable Pedal Distance, 10 Level Speed Adjusting Function, 무균 시료 분쇄기, 미생물 실험 전처리



Sample Mixer “BLD-1620”
 With Powerful Stomaching Mechanism
 for 330~1620ml Bags

- Made in Korea
- PL(Product Liability) Insurance
- Food Microbiology, Veterinary, Clinical, Pharmaceutical, Molecular Extraction, Toxin Research, Environmental Analyses
- 10 Level Motor Speed Adjusting Function
- Ergonomic Design with ABS body.
- Strong Door Lever : Easy to Open & Close
- Power Stomaching Mechanism.

- * For Blending and Filtering Solid Samples for Microbiological Analysis.
- * Pedal Distance Adjust Function Ensure Quick and Precise Sterile Blending of Samples
- * Multifunction Digital Control Display for Monitoring Operating Condition, Speed, Time
- * ABS Body
- * Cost Effective.

Specifications & Ordering Information

Spec.	Model	Sample Mixer “BLD-1620”
Capacity		330ml ~ 1620ml
Speed		1 ~ 10 Level (1~8 stroke/sec)
Pedal Distance Adjust		0 ~ 50mm
Display		Digital Control Display
Controller		Digital Controller
Timer		Continuous & 0 ~ 99 min 59 sec
Motor		BG65×50 (100W) + SG80K (1/10), Dunker
Door		Transparent Window
Dimensions		200×366×h232mm
Weight		15kg
Power Consumption		DC 24V 6.5A
Power Supply*		220V, 60Hz (Fuse 2A 250V)
Cat. No.		DH.Ble001
Price, Each. ₩		

※ NOTE : Design and Specification can be changed when it's released

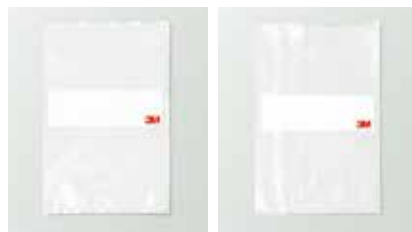

(1) Plain type 190×300mm
 (2) Filter type 190×300mm



(3) Filter & Wire type 190×300mm
 (4) Wire type 190×300mm

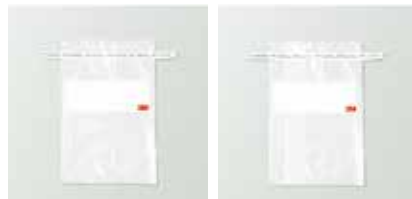

(5) Wire type 150×230mm
 (6) Filter & Wire type 150×230mm

Sterile Sample Bags for Sample Mixer

Model	1930	1930F	1930FW	1930W	1523W	1523FW	
Volume	Up to 1,620ml				Up to 710ml		
Sterilization	Gamma Sterilization						
Sampling	Multi Use						
Filter	Type	None	Lateral	Lateral	None	Lateral	
	Porosity	5~150um					
	Material	None	Non-woven	Non-woven	None	None	Non-woven
Bag	Size	190×300mm				150×230mm	
	Material	PE	PE+Nylon	PE+Nylon	PE	PE	PE+Nylon

- 3M.06.1930 (1) Sample Bag, 190×300mm, 1620ml, Plain type
- 3M.06.1930F (2) , Filter type
- 3M.06.1930FW (3) , Filter & Wire type
- 3M.06.1930W (4) , Wire type
- 3M.06.1523W (5) , 150×230mm, 710ml, Wire type
- 3M.06.1523FW (6) , Filter & Wire type

Pk.	Price, ₩	Cs.	Price, ₩
50ea		10pk	
50ea		10pk	
		250ea	
		500ea	
		500ea	
		250ea	

How to use Sample Bag

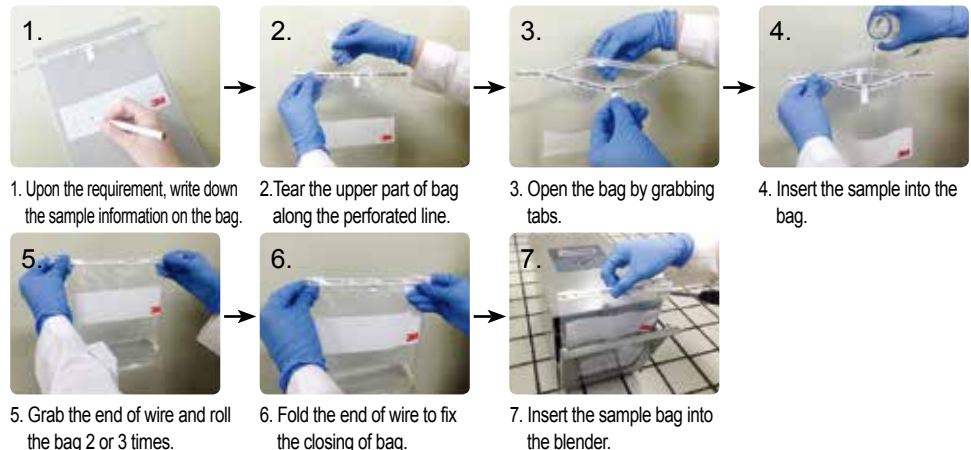

DAIHAN Scientific

Centrifuge

Centrifuge, Mini-micro P.40
 , Pro-micro P.41~42
 , Table-top Classic P.43
 , Table-top Microprocessor P.44



“MaXpin C-6mt”

“CF-5”

Mini-micro Centrifuge

6 × 0.2 / 0.5 / 1.5 / 2.0 ml Tubes



“CF-10”

“MaXpin C-12mt”

Pro-micro Centrifuge

12 × 0.2 / 0.5 / 1.5 / 2.0ml



Table-top Classic Centrifuge

6 / 12 / 24 × (1.5~50)ml

“Cef-50.6”



Table-top Microprocessor Centrifuge

6 / 12 / 24 × (1.5~50)ml

“Cef-D50.6”

DAIHAN® Hi-Quality Mini-microcentrifuge Set “MaXpin C-6mt”, Max. 5,500 rpm, Rapidly Stop Spin-motion for safety With Circular Fixed-Angle Rotor for 6×0.2/0.5/1.5/2.0ml Tubes and Strip Rotor for 2×0.2ml PCR 8-tubes Strips/16×0.2ml PCR Tubes 미니-마이크로 원심분리기 세트, 신속한 회전동작 정지, 앵글-/스트립-로터 포함, 0.2/0.5ml 튜브 어댑터 포함



“MaXpin C-6mt” for 6 Tubes of 0.2 ~ 2.0ml with Circular Fixed Angle Rotor

- Made in Korea ■ PL(Product Liability) Insurance ■ Rapidly Stop Spin-motion for user safety
- * with Certificate & Traceability * Complete Set with Circular Fixed-Angle Rotor and Fixed Strip Rotor
- * Supplied with two Rotors :
 - Circular Fixed-Angle Rotor for 6×0.5-/1.5-/2.0-ml Tubes (6×0.2-/0.5-ml tube Adapters included)
 - Strip Rotor for 2×0.2ml PCR 8-tubes Strips or 16ea of individual 0.2ml PCR Tubes
- * Smooth Opening of the Lid by Simply Pressing * Rubbimized Base
- * Lid-Activated On/Off Safety Switch : Close the Clear Lid to Start and Open to Stop

Specifications & Ordering information

Spec.	Model	“MaXpin C-6mt”, Rapidly Stop Spin-motion for safety
RPM & Max. RCF		Max. 5,500 rpm, 1,775×g
Max. Capacity		6×0.5-/1.5-/2.0-ml tubes, 2×0.2ml PCR 8-tube Strip or 16×0.2ml PCR 8 Tubes
Rotor (included)	Angle Rotor	6 Holes Circular Fixed-Angle Rotor for 0.5-/1.5-/2.0-ml Tubes
	Strip Rotor	16 Holes Strip Rotor for 0.2ml PCR 8-tube Strip or individual Tubes
Adapter		Included 6×0.2-/ 0.5-ml Tube Adapter
Material		Lid-PC, Body-ABS, Rotor-ABS
Dimension (w×d×h)		Unit : 144×192 ×h108 mm, 1.1kg, Packing : 175×255×h215 mm, 1.6 kg
Power Consumption		8 W
Electric Reqts.		1 Phase, AC 100 ~ 240V, 50/60Hz
Cat. No.	230V	DH.WCF00006
	120V	DH.WCF00026
Price, Each. ₩		

* Other Specifications are available upon Customer's Request.

DAIHAN® High performance Mini-microcentrifuge Set “CF-5”, Class-I Medical Device(NIDS), Max. 5,500 rpm With Circular Fixed-Angle Rotor for 6×0.2/0.5/1.5/2.0ml Tubes and Strip Rotor for 2×0.2ml PCR 8-tubes Strips/16×0.2ml PCR Tubes 미니-마이크로 원심분리기 세트, 앵글-/스트립-로터 포함, 0.2/0.5ml 튜브 어댑터 포함



Circular Fixed-Angle Rotor for 6×0.2~2.0ml Tubes

“CF-5” for 6 Tubes of 0.2 ~ 2.0ml with Circular Fixed Angle Rotor

- Made in Korea ■ CE Certified ■ PL(Product Liability) Insurance
- * with Certificate & Traceability * Complete Set with Circular Fixed-Angle Rotor and Fixed Strip Rotor
- * Supplied with two Rotors :
 - Circular Fixed-Angle Rotor for 6×0.5-/1.5-/2.0-ml Tubes (6×0.2-/0.5-ml tube Adapters included)
 - Strip Rotor for 2×0.2ml PCR 8-tubes Strips or 16ea of individual 0.2ml PCR Tubes
- * Smooth Opening of the Lid by Simply Pressing * Operation Display LED Lamp
- * Lid-Activated On/Off Safety Switch : Close the Clear Lid to Start and Open to Stop

Specifications & Ordering information

Spec.	Model	“CF-5”
RPM & Max. RCF		Max. 5,500 rpm, 1,775×g
Max. Capacity		6×0.5-/1.5-/2.0-ml tubes, 2×0.2ml PCR 8-tube Strip or 16×0.2ml PCR 8 Tubes
Rotor (included)	Angle Rotor	6 Holes Circular Fixed-Angle Rotor for 0.5-/1.5-/2.0-ml Tubes
	Strip Rotor	16 Holes Strip Rotor for 0.2ml PCR 8-tube Strip or individual Tubes
Adapter		Included 6×0.2-/ 0.5-ml Tube Adapter
Material		Lid-PC, Body-ABS, Rotor-ABS
Dimension (w×d×h)		Unit : 178×150 ×h109 mm, Packing : 200×180×h175 mm, 2 kg
Power Consumption		8 W
Electric Reqts.		1 Phase, AC 100 ~ 240V, 50/60Hz
Cat. No.	230V	DH.WCF00005
	120V	DH.WCF00025
Price, Each. ₩		

* Other Specifications are available upon Customer's Request.

Fixed Rotor & Adapter for Spare, 0.2-/0.5-ml Tube Adapter-set, 스페어 로터/튜브 어댑터

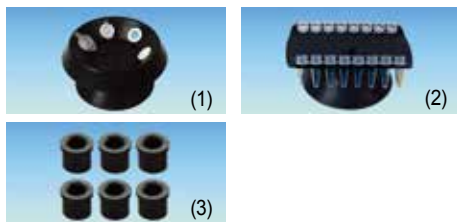

- DH.WCF00105 (1) Circular Fixed Angle Rotor, for “MaXpin C-6mt”, “CF-5” for 6×0.2-/0.5-/1.5-/2.0-ml Tubes
- DH.WCF00205 (2) Fixed Strip Rotor, for “MaXpin C-6mt”, “CF-5” for 2×0.2ml PCR8-tube Strips or 16×0.2ml PCR Tubes
- DH.WCF00201 (3) 0.2ml Tube Adapter-sets, 6ea Adapter/1set, for Circular Fixed Angle Rotor, for “MaXpin C-6mt”, “CF-5”
- DH.WCF00301 (3) 0.5ml Tube Adapter-sets, 6ea Adapter/1set, for Circular Fixed Angle Rotor, for “MaXpin C-6mt”, “CF-5”

Ea. Price, ₩

DAIHAN® High-Performance Pro-microcentrifuge Set “CF-10”, **Class-I Medical Device(NIDS)**, Max. 13,500rpm With MC Nylon Fixed Angle Rotor for 12×0.2-/0.5-/1.5-/2.0-ml Tubes, Compact, Quiet, Safety Electronic Lid Lock System
 프로-마이크로 원심분리기, 전자식 안전 도어 잠금 시스템, Fixed Angle Rotor & 0.2/0.5ml 튜브 어댑터 포함



“CF-10” for 12 Tubes of 0.2 ~ 2.0ml with MC Nylon Fixed Angle Rotor

- Made in Korea
- CE Certified
- Unbelievably Quiet Operation - Brushless DC motor
- High Performance - Digital Feedback Speed Control, Max. 13,500rpm, 12,225×g
- Useful Exclusive Spin Down Function
- Included MC Nylon Fixed Angle Rotor for 1.5-/2.0-ml×12 Tubes and 12×0.2-/0.5-ml PCR Tube Adapters
- Patented Jog-Shuttle Control System and Digital LCD with Back-Light Function
- PL(Product Liability) Insurance
- * Plasmid, DNA and RNA work, protein work, and miniprep kit, Cell Culture, cell harvesting, subcellular separations, and many other applications.
- * Unnecessary Rotor Lid for Running and Reducing Noise (≤57dB at Max. RPM).
- * Realize Extremely Compact Design with Exceptionally Small Footprint.
- * Acceleration and Braking Times are Lower than 15 sec (at Max. Speed).
- * Storage Function for the Set Values : RPM & Time.
- * Locking Mode Supported for Experimental Safety (Input to Jog-Shuttle can be disabled).
- * Safety System for Motor Error.
- * **Safety Electronic Lid Lock System** : Opening Lid is not applicable during running.
- * Simple Operation for Repetitive use of ‘Spin Down’ Function.

Specifications & Ordering information

Spec.	Model	“CF-10”
RCF		1,000~13,500 RPM , 12,225×g
Max. Capacity		0.2-/0.5-/1.5-/2.0-ml×12 Tubes
Rotor		MC Nylon Fixed Angle Rotor for 0.2-/0.5-/1.5-/2.0-ml×12 Tubes
Drive System		Brushless DC motor, Direct drive
Noise Level		≤57 dB
Acceleration & Braking Time		≤15 sec (at Max. speed)
Cooling Device		Air Cooling System
Timer & Alarm		99hr 59min (Continuous run), Error status & Timer-end
Display		Digital LCD with Back-Light Function
Controller		Digital Feedback Control with Jog-Shuttle Switch (Turn+Push)
Safety Circuit		Motor Error Detector, Electronic Safety Lid Lock System
Material		Lid-PC, Body-ABS, Rotor-PE
Dimension & Weight		170×226×h183 mm, 2.3 kg
Packing Size & Gross Weight		290×240×h220 mm, 5 kg
Power Consumption		90W
Electric Reqts.		1 Phase, AC 120V, 50/60Hz or AC 230V, 50 / 60Hz

Cat. No.	230V	DH.WCF00010
	120V	DH.WCF00011
Price, Each. ₩		

* Other Specifications are available upon Customer’s Request.



(1) MC Nylon Fixed Angle Rotor for 12×0.2-/0.5-/1.5-/2.0-ml



(2) Tube Adapter 12×0.2/0.5ml Tube Adapter

Spare Rotor & Adapter Set

- DH.WCF00100 MC Nylon Fixed Angle Rotor, “CFAR1512”, for “CF-10”, 12×0.2-/0.5-/1.5-/2.0-ml Tubes
- DH.WCF00200 0.2ml Tube Adapter-sets, 12ea Adapter/1set, for Fixed Angle Rotor, “CFTA1”
- DH.WCF00300 0.5ml Tube Adapter-sets, 12ea Adapter/1set, for Fixed Angle Rotor, “CFTA2”

Ea. Price, ₩	

DAIHAN® Premium Pro-microcentrifuge Set **“MaXpin C-12mt”**, Max. 13,500rpm, 12,225 × g
 With **Aluminum Die Casting Lid** & Electronic Lid Lock System for safety, Autoclavable PP Fixed Angle Rotor for 12 × 0.2-/0.5-/1.5-/2.0-ml Tubes
 프로-마이크로 원심분리기, 전자식 안전 도어 잠금 시스템, 앵글 로터 포함, 0.2/0.5ml 튜브 어댑터 포함



Max. 13,500 rpm

2-Year Warranty

“MaXpin C-12mt” for 12 Tubes of 0.2 ~ 2.0ml with PP Fixed Angle Rotor

- Made in Korea ■ PL(Product Liability) Insurance
- Unbelievably Quiet Operation due to Optimized Air Flow Design (Noise Level ≤ 57db)
- Brushless DC Motor Provides Maintenance Free Operation.
- Perfectly Constructed Frame Structure. Strong Layered Aluminum Die Casting Lid with Auto Lock Mechanism Assuring a Safe and Secure Lock.
- High Performance - Digital Feedback Speed Control, Max. 13,500rpm, 12,225 × g
- Useful Exclusive Spin Down Function
- Supplied in Complete Set : PP Fixed Angle Rotor for 1.5-/2.0-ml × 12 Tubes and PCR Tube Adapters (12 × 0.2ml & 12 × 0.5ml)
- Patented Jog-Shuttle Control System and Digital LCD with Back-Light Function
- * Easy to Use Compact Design Allows for Fast Centrifugation * Sleek, Space Saving Footprint
- * Intuitive Controls and Easy to Read Display Simplifies Operation.
- * Ideal for Fast Isolating and Pelleting of DNA, RNA, Proteins, and Cell Viruses
- * Max. 13,500 rpm with 12 Position, Autoclavable PP Fixed Angle Micro-Rotor
- * Large Backlit LCD-screen for Settings and Parameters
- * The System Displays Errors, Excess Speed, and Open Lid.
- * Load Imbalance Detection.
- * Strong Steel Layered Door with Safety, Auto-Lock Function
- * Automatic Door Release * Easy to Close Lid
- * Biocontainment Rotor Lid Ensuring Securely Contained Samples
- * Soft Brake Function to Protect Delicate Samples
- * PP Inner Lid for Maximize Safety (Optional)



* Aluminum Die Casting Lid

(1) PP Fixed Angle Rotor (Included)

Perfectly Constructed Frame Structure, Strong Layered Lid

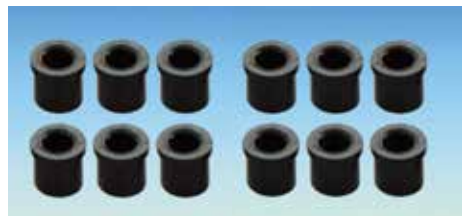

(2) Tube Adapter(Included)
12 × 0.2/0.5ml Tube Adapter

Specifications & Ordering information

Spec.	Model	“MaXpin C-12mt” Aluminum Die Casting Lid & Electronic Lid Lock System
RCF		1,000~13,500 RPM , 12,225 × g
Max. Capacity		0.2-/0.5-/1.5-/2.0-ml × 12 Tubes
Rotor (included)		PP Fixed Angle Rotor for 0.2-/0.5-/1.5-/2.0-ml × 12 Tubes
Adapter (included)		12 × 0.2ml & 12 × 0.5ml PCR Tubes
Drive System		Brushless DC motor, Direct drive, Vibration Insulated, Counterclockwise Rotating
Noise Level		≤ 57 dB
Acceleration & Braking Time		≤ 12 sec (at Max. speed)
Cooling Device		Air Cooling System
Timer & Alarm		99hr 59min (Continuous run), Error status & Timer-end
Display		Large Digital LCD with Back-Light Function
Controller		Digital Feedback Control with Jog-Shuttle Switch (Turn+Push)
Safety Circuit		Motor Error Detector, Electronic Safety Lid Lock System
Material		Lid-Aluminum Die Casting, Body-ABS, Rotor-PE
Dimension & Weight		187 × 253 × h155 mm, 3.8 kg
Packing Size & Gross Weight		230 × 290 × h245 mm, 4.3 kg
Power Consumption		90W
Electric Reqts.		1 Phase, AC 120V, 50/60Hz or AC 230V, 50/60Hz

Cat. No.	230V	DH.WCF01350
	120V	DH.WCF01351
Price, Each. ₩		

* Other Specifications are available upon Customer's Request.

Spare Rotor & Adapter Set

- DH.WCF11350 (1) PP Fixed Angle Rotor, Autoclavable, for “MaXpin C-12mt”, 12 × 0.2-/0.5-/1.5-/2.0-ml Tubes
- DH.WCF00200 (2) 0.2ml Tube Adapter-sets, 12ea Adapter/1set, for Fixed Angle Rotor, “CFTA1”
- DH.WCF00300 (2) 0.5ml Tube Adapter-sets, 12ea Adapter/1set, for Fixed Angle Rotor, “CFTA2”

Ea. Price, ₩

DAIHAN® 1.5~50ml Popular Classic Centrifuge “Cef”, **Class-I Medical Device(NIDS)**, 3000- & 6000-rpm
 With 6- & 8-Holes, or 12- & 24-Holes(in 50ml Model) Fixed Angle Rotor, Safety Balance, 1.5~50ml 튜브용 경제형 원심분리기



I. “Cef-6” for 6 Tubes of 1.5~15ml, with 6 Holes Fixed Angle Rotor, 3000rpm



II. “Cef-8” for 8 Tubes of 1.5~15ml, with 8 Holes Fixed Angle Rotor, 6000rpm



III. “Cef-50.6” for 6 Tubes of 50ml, with 6 Holes Fixed Angle Rotor, 4000rpm

- DAIHAN Designed
- Speed is Linear and Stables
- Interchangeable Rotor
- with 6- & 8-Holes or 12- & 24-Holes Fixed Angle Rotor for 1.5ml ~ 50ml Tubes ; On Adapters Adjustable 1.5/2ml, 5~7ml, 10~15ml, and 50ml

- * The Design is up-to-date, Beautiful Outlook and Durable
- * Auto-balancing System
- * Steppless Controller : Speed and Operating Time
- * ABS Outer Shell can Resist Collision.
- * with Safety Switch when Centrifuge Lid Opened the Motor can be Stop

Specifications & Ordering information

Spec.	Model	I. 15ml “Cef-6” 6 Holes - 1.5~15ml	II. 15ml “Cef-8” 8 Holes - 1.5~15ml	III. 50ml “Cef-50.6” 6 Holes - 50ml or 12/24 Holes - 1.5~15ml
		Fixed Angle Rotor&Capa.	Included Option	6Hole ; (1.5~15)ml Tubes
Useful Tube size & Acceptance		6 Tubes ; 10~15ml, 1.5~7ml on Adapters	8 Tubes ; 10~15ml, 1.5~7ml on Adapters	(1) 6 Tubes ; 50ml When option Rotor ; (2) 12 Tubes ; 10~15ml (3) 24 Tubes ; 10~15ml 1.5~7ml on Adapters
Adapter and Size	Included Option	② 6ea×10~15ml Tubes Size ; id17.5×L95mm ③ 6ea×5~7ml Tubes Size ; id13.5×L69mm ④ 6ea×1.5/2ml Tubes Size ; id11×L42mm	② 8ea×10~15ml Tubes Size ; id17.5×L95mm ③ 8ea×5~7ml Tubes Size ; id13.5×L69mm ④ 8ea×1.5/2ml Tubes Size ; id11×L42mm	① 6ea×50ml Tubes Size ; id30.7×L104mm ② 12/24ea×10~15ml Tubes Size ; id17.5×L95mm ③ 12/24ea×5~7ml Tubes Size ; id13.5×L69mm ④ 12/24ea×1.5/2ml Tubes Size ; id11×L42mm
Speed Range (rpm)		300~3000rpm at 60Hz (300~2500rpm at 50Hz)	300~6000rpm	600~4000rpm
R.C.F		1,066×g	4,265×g	2,325×g
Display		None	Tachometer for Speed & R.C.F	None
Timer		0~30min Analog Timer		
Motor		Induction Motor		DC Motor
Safety Manual Brake		None		Yes None
Dimension & Weight		280×280×h255mm, Net. 3.5kg, Gross. 4kg	280×280×h265mm, Net. 4.5kg, Gross. 5kg	300×300×h315mm, Net. 8.5kg, Gross. 9kg
Electric Reqt		AC 230V, 50/60Hz or AC 120V, 60Hz		
Cat. No.	230V	DH.Cef0006	DH.Cef0008	DH.Cef0010
	120V	DH.Cef0106	DH.Cef0108	DH.Cef0110
Price, Each. ₩				

Spare Rotor and Tube Adapter

- DH.CefR5006 (1) 50ml 6Holes Angle Rotor “R5006” with 6ea×50ml Tube Adapter PP “TA50”, idφ 30.7×L104mm, for “Cef-50.6” & “Cef-D50.6”
- DH.CefA050 ① 50ml Tube Adapter PP “TA50”, idφ 30.7×L104mm, Fit to Rotor “R5006”, for Centrifuge “Cef-50.6” & “Cef-D50.6”
- DH.CefA015 ② 10~15ml Tube Adapter PP “TA15”, idφ 17.5×L98mm, for Centrifuge “Cef-6” & “Cef-8”, and Rotor “R1512” & “R1524”

Ea. Price, ₩

Optional Rotor and Tube Adapter

- DH.CefR1512 (2) 10~15ml 12Holes Angle Rotor “R1512”, with 12ea×10/15ml Tube Adapter “TA15”, idφ 17.5×L98mm, for Centrifuge “Cef-50.6” & “Cef-D50.6”
- DH.CefR1524 (3) 10~15ml 24Holes Angle Rotor “R1524”, with 24ea×10/15ml Tube Adapter “TA15”, idφ 17.5×L98mm, for Centrifuge “Cef-50.6” & “Cef-D50.6”
- DH.CefA007 ③ 5~7ml Tube Adapter PP “TA7”, idφ 13.5×L69mm, Fit to “TA15”, Tube Adapter, for Centrifuge “Cef-6”, “Cef-8”, “Cef-50.6”, and “Cef-D50.6”
- DH.CefA002 ④ 1.5/2ml Tube Adapter PP “TA2”, idφ 11×L42mm, Fit to “TA15”, “TA1503” Tube Adapter, for Centrifuge “Cef-6”, “Cef-8”, “Cef-50.6”, and “Cef-D50.6”

Ea. Price, ₩



(1) Fixed Angle Rotor ; 50ml 6Holes, “R5006”



(2) Fixed Angle Rotor ; 10~15ml 15Holes, “R1512”



(3) Fixed Angle Rotor ; 10~15ml 24Holes, “R1524”



Optional Tube Adapter

DAIHAN® 1.5~50ml Microprocessor Centrifuge “Cef-D50.6”, **Class-I Medical Device(NIDS)**, Max. 4000rpm
 With 6-Holes or 12- & 24-Holes Fixed Angle Rotor, Digital Model, Safety Interlock, 1.5~50ml 튜브용 디지털 원심분리기



Class-I Medical Device
 Max. 4,000 rpm

2-Year Warranty

“Cef-D50.6” for 6 Tubes of 50ml,
 with 6 Holes Fixed Angle Rotor, 4000rpm



①TA50
 (1) Fixed Angle Rotor ; 50ml
 6Holes, “R5006”



②TA15
 (2) Fixed Angle Rotor ; 10~15ml
 12Holes, “R1512”



②TA15
 (3) Fixed Angle Rotor ; 10~15ml
 24Holes, “R1524”



(4) Swing Rotor ; 4×50ml, 12×1.5/2ml
 & 10~15ml, 16×5~7ml “SR1550”
 Included ⑤,⑥,⑦ / Option ④

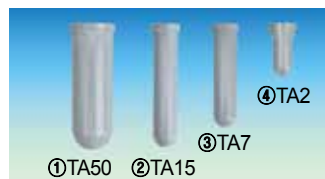

①TA50 ②TA15
 Optional Tube Adapter

- **DAIHAN Designed** ■ **Durable and Maintenance Free - Brushless DC Motor**
- **Ideal for Biology, Medicine, Pharmacology, Laboratory, etc. Various Application**
- **with 6-Holes or 12- & 24-Holes Fixed Angle Rotor for 1.5ml ~ 50ml Tubes ; On Adapters Adjustable 1.5/2ml, 5~7ml, 10~15ml, and 50ml**
- **Automatic Quick Self-Cooling by Fan** ■ **Interchangeable Rotor**
- * Compact Design with Automatic Door Release. * Easy to Use Controls and Display
- * Self-diagnostic Function : Lid Opening, Unbalance, Over-Heat/ Current/ Voltage/ Speed
- * Auto-balancing System for Extend Motor Life and Reduce Noise
- * Program Memory Function : 9Set. * Precision Digital Timer, Set to 10Sec. / Max 30 Min
- * Pushing the Function Key for Short Runs * Rapid Deceleration due to Automatic Brake System

Specifications & Ordering information

Spec.		Model	“Cef-D50.6”
			6 Holes - 50ml or 12/24 Holes - 1.5~50ml
Fixed Angle Rotor&Capa.	Included		(1) 6Hole ; 50ml Tubes
	Option		(2) 12Hole ; (1.5~15)ml Tubes, (3) 24Hole ; (1.5~15)ml Tubes
Swing Rotor & Capa.	Option		(4) SR1550 ; ⑤ 4×1Hole - 50ml, ⑥ 4×3Hole - 10~15ml, ⑦ 4×4Hole : 5~7ml, ⑧+④ 4×3Hole : 1.5/2.0ml
			(1) 6 Tubes ; 50ml
Useful Tube size & Acceptance		When Option Fixed Angle Rotor	When Option Swing Rotor ; (4) SR1550
		(2) 12 Tubes ; 1.5~15ml (3) 24 Tubes ; 1.5~15ml	⑤ 4 Tubes : 50ml, ⑥ 12 Tubes : 10~15ml ⑦ 16 Tubes : 5~7ml ⑧+④ 12 Tubes : 1.5/2.0ml
Adapter and Size	Included		① 6ea×50ml Tubes, Size ; id30.7×L104mm
	Option	When Option Fixed Angle Rotor ② 12/24ea×10~15ml Tubes Size ; id17.5×L95mm ③ 12/24ea×5~7ml Tubes Size ; id13.5×L69mm ④ 12/24ea×1.5/2ml Tubes Size ; id11×L42mm	When Option Swing Rotor ; ⑤ 4×1Hole - 50ml Tubes ⑥ 4×3Hole - 10~15ml Tubes ⑦ 4×4Hole - 5~7ml Tubes ⑧+④ 4×3Hole - 1.5/2.0ml Tubes
Speed Range (rpm) & RCF			600~4000rpm & 2,325×g (Swing Rotor ; 2,683×g)
Motor			Brushless DC Motor
Timer			0~30min
Dimension & Weight			390×505×290mm, 19.8kg, Gross. 21.8kg
Electric Reqts.			AC 230V, 50/60Hz or AC 120V, 60Hz
Cat. No.	230V		DH.CefD0030
	120V		DH.CefD0130
Price, Each. ₩			

* Other Specifications are available upon Customer's Request.

Spare Rotor and Tube Adapter

- DH.CefR5006** (1) 50ml 6Holes Angle Rotor “R5006” with 6ea×50ml Tube Adapter PP “TA50”, idφ 30.7×L104mm, for “Cef-50.6” & “Cef-D50.6”
- DH.CefA050** ① 50ml Tube Adapter PP “TA50”, idφ 30.7×L104mm, Fit to Rotor “R5006”, for Centrifuge “Cef-50.6” & “Cef-D50.6”
- DH.CefA015** ② 10~15ml Tube Adapter PP “TA15”, idφ 17.5×L98mm, for Centrifuge “Cef-6” & “Cef-8”, and Rotor “R1512” & “R1524”

Ea. Price, ₩

Optional Rotor and Tube Adapter

- DH.CefR1512** (2) 10~15ml 12Holes Angle Rotor “R1512”, with 12ea×10/15ml Tube Adapter “TA15”, idφ 17.5×L98mm, for Centrifuge “Cef-50.6” & “Cef-D50.6”
- DH.CefR1524** (3) 10~15ml 24Holes Angle Rotor “R1524”, with 24ea×10/15ml Tube Adapter “TA15”, idφ 17.5×L98mm, for Centrifuge “Cef-50.6” & “Cef-D50.6”
- DH.CefSR1550** (4) Swing Rotor “SR1550”, with Tube Adapter PP 1Hole×4ea×50ml “TA5001”, 3Hole×4ea×1.5/2ml & 10~15ml “TA1503” and 4Hole×4ea×5~7ml “TA704”, for Centrifuge “Cef-D50.6”
- DH.CefA007** ③ 5~7ml Tube Adapter PP “TA7”, idφ 13.5×L69mm, Fit to “TA15”, Tube Adapter, for Centrifuge “Cef-6”, “Cef-8”, “Cef-50.6”, and “Cef-D50.6”
- DH.CefA002** ④ 1.5/2ml Tube Adapter PP “TA2”, idφ 11×L42mm, Fit to “TA15”, “TA1503” Tube Adapter, for Centrifuge “Cef-6”, “Cef-8”, “Cef-50.6”, and “Cef-D50.6”
- DH.CefA5001** ⑤ 50ml Tube Adapter PP “TA5001”, Fit to Rotor “SR1550”, for Centrifuge “Cef-D50.6”
- DH.CefA1503** ⑥ 10~15ml 3Hole Tube Adapter PP “TA1503”, Fit to Rotor “SR1550”, for Centrifuge “Cef-D50.6”
- DH.CefA704** ⑦ 5~7ml 4Hole Tube Adapter PP “TA704”, Fit to Rotor “SR1550”, for Centrifuge “Cef-D50.6”

Ea. Price, ₩

DAIHAN® -20+40°C Chiller “MaXircu™ Chi”, Heavy-duty Refrigerated External Circulator, Fill-17 · 29 · 47 Lit
 Ideal for Evaporator/Reactor &c. Cooling Line, Lift 8 · 27m, Cooling Capa 0.87 · 1.3 · 3.0 kW, 다용도 냉각 써클레이터/칠러



Max. Filling Volume 29Lit, “MaXircu™ Chi-30”



Assembly-type Safety Connection Ports/Pipe for Fluid In/Out-let ; ISO RC 1/2" Thread, Located On Rear-Upper Panel

- Made in Korea
- PL (Product Liability) Insurance
- with Certificate & Traceability : Controlled by Serial Number, Certificate, Delivery-information, and Traceable Data Base System
- Ideal for Wide-range Reaction System and Evaporator. ■ Max. Lift 8 · 27m
- Assembly-type Safety Connection Ports/Pipe for Fluid In/Out-let : ISO RC 1/2" Thread, Stainless-steel.
- Digital PID Control System Implementing Superior Temperature Accuracy.
- Embedded External Nozzle Part for the Prevention of Nozzle Damaged.
- Stainless-steel Internal Bath for Prevention of Corrosion.
- * Wide-range Filling Volume 17Lit · 29Lit · 47Lit
- * Effective Cooling Capacity
- * Useful for 1~50Lit Various Reactors and Evaporators.
- * Emergency Stop Button for safety.
- * High Quality Circulation Pump : 20 · 30 Lit/min Max Flow Rate and 1.0-/3.3-bar Max. Pressure.
- * Built in Pump Pressure Gauge and Compressor Pressure Gauge.

Specifications & Ordering information

Spec.	Model	“MaXircu™ Chi-20” Filling Volume Max. Capa. 17Lit	“MaXircu™ Chi-30” Filling Volume Max. Capa. 29Lit	“MaXircu™ Chi-50” Filling Volume Max. Capa. 47Lit
Temp. Range & Stability		-20°C ~ +40°C-Range, ±0.2°C(at 15°C)-Stability		
Cool-Fluid. Filling Volume		17 Lit max	29 Lit max	47 Lit max
Useful for 1~50Lit Evaporators, etc.		for 1~20Lit Evaporator	for 10~30Lit Evaporator	for 20~50Lit Evaporator
Refrigerator Capacity(HP)		1/2 HP	1 HP	2 HP
Lid & Top Opening Dia.		φ100 mm		
Fluid In/Out-let Connector		ISO RC 1/2" (English System AG 1/2") Thread, Stainless-steel		
Pump Power, Lift Height, m	Max. Flow Rate	20 Lit/min	30 Lit/min	
	Max. Pressure & Lift	1.0 bar Max. Lift : 8m	3.3 bar Max. Lift : 27m	
Cooling Capacity	at +20°C	1.7 kW	2.8 kW	6.5 kW
	at 0°C	0.87 kW	1.3 kW	3.0 kW
	at -20°C	0.32 kW	0.45 kW	1.2 kW
External Dimension		450×650×h900 mm	580×800×h1260 mm	670×900×h1450 mm
Material		Internal : Stainless-steel, External : Powder Coated steel		
Electrical Reqts.		1 Phase 230V, 50 / 60 Hz		3Phase 380V
Cat. No.	60Hz	DH.Chi0020	DH.Chi0030	DH.Chi0050
	50Hz	DH.Chi0025	DH.Chi0035	DH.Chi0055
Price, Each. ₩				

* Other Specifications are available upon Customer's Request.

※ 운임 약 ₩ 20,000 별도!

- ※ See page 37 for the Cooling/Heating Transfer Fluid & Circulation Hose ;
- ▶ Therminol D12® -85+230°C Cooling/Heating Transfer Fluid
- ▶ SYN THERM 22L® -5+320°C Heating Transfer Fluid
- ▶ Insulated External Circulating Tubing

※ Note : Cooling Transfer Fluid Should be an Antifreezing Solution



▶ Figure : One of the Applications in the Large Volume Evaporator Line.

Desiccator Cabinet

Desiccator, Auto-Dry	P. 48~49
, Gas Exchangeable	P. 47
, General Purpose	P. 47
, UV Protection Auto-Dry	P. 49
, Vacuum	P. 49
, Accessory, Silica-Gel New	P. 49



General Purpose Desiccator
"DeLL", 33Lit



Gas Exchangeable Desiccator
"DeBG1K", 207Lit



Auto-Dry Desiccator
"DeADLH", 33Lit



Auto-Dry Desiccator
"DeADAWS", 604Lit



UV Protection Auto-Dry Desiccator
"DeADLL.UV", 33Lit



Vacuum Desiccator
"DeVL", 12Lit

Articles	Cat. No	Description
----------	---------	-------------

2-Year Warranty



(1) Short-model



(2) Tall-model

DAIHAN® 33Lit General Purpose PMMA Desiccator, Short- & Tall-form With ABS Frame · Shelf · Desiccant Tray, [Korean-made], 범용 PMMA 데시케이터

- **Excellent Viewing & Air Tight Structure ; Heavy-duty ABS(Acrylonitrile Butadiene Styrene Resin) Frame, 3mm Clear PMMA(Polymethyl Methacrylate Resin) Body Panel & 5mm Shelf, and Rubber Sealing Door.**
- * Adjustable Shelf Quantity & Height / Distance.
- * 2kg Shelf Load. * 30mm Shelf Moving Interval.
- * Including 1 Urea Tray 190×273mm for Silica-gel / Desiccant.

※ 운임 약 ₩ 6,000 별도!

(1) 33Lit Short-model "DeLL", 1-PMMA Shelf

DH.DeLL General Desiccator, Short-model, 33Lit, "DeLL"
Outer : 450×330×h350mm, Inner : 400×305×h270mm

Ea.	Price, ₩

(2) 33Lit Tall-model "DeLH", 3-PMMA Shelf

DH.DeLH General Desiccator, Tall-model, 33Lit, "DeLH"
Outer : 330×330×h480mm, Inner : 270×305×h400mm

Ea.	Price, ₩

DH.DeSH003 Spare, PMMA Shelf, for Short-model, 397×302×thick 5mm, Load 2kg
DH.DeSH002 , for Tall-model , 267×302×thick 4mm, Load 2kg

2-Year Warranty



(1) Bench-model



(2) Floor-model

with Digital Thermo-Hygrometer & Gas Valve

DAIHAN® 164·207·320·640·604Lit Gas Exchangeable PMMA Desiccator, 1 & 4 Room With Digital Thermo-Hygrometer · Gas Valve · SUS Shelf, [Korean-made], 가스치환 데시케이터

- **Excellent Viewing & Air Tight Structure ; Heavy-duty Aluminium Frame, 5mm Clear PMMA(Polymethyl Methacrylate Resin) Body Panel, Stainless-steel Shelf, Caster, and Rubber Sealing Door.**
- * Ideal for Sample Storage / precise Instrument / Semiconductive Articles / Low Humidity, Characterization Test, etc.
- * 20kg Shelf Load. * 50mm Shelf Moving Interval.
- * Adjustable Shelf Quantity & Height / Distance.
- * With Gas Valve / Gas Exchange / Stainless-steel Shelf / 1 Urea Tray 345×440mm for Desiccant / 1Digital Thermo-Hygrometer(But 4ea in 604Lit 4Room)

※ 운임 약 ₩ 16,000 별도!

(1) 164Lit Bench Model "DeBG2", 1Room - 1Door, 2Shelf, 2Gas Valve

DH.DeBG2 164Lit Desiccator, Gas-Ex. "DeBG2", 1Room, 2Shelf
Outer : 574×535×h765mm, Inner : 490×460×h730mm
Including 2 Shelf, 1 Silica gel Tray, and 2 Gas Valve

Ea.	Price, ₩

(2) 207Lit Floor Model "DeBG1K", 2Room - 2Door, 4Shelf, 2Gas Valve, Caster

DH.DeBG1K 207Lit Desiccator, Gas-Ex. "DeBG1K", 2Room - 2Door, 4Shelf
Outer : 574×535×h1070mm, Inner : 490×460×h920mm
Including 4 Shelf, 1 Silica gel Tray, and 2 Gas Valve

Ea.	Price, ₩

※ 운임 약 ₩ 30,000 별도!

(3) 320Lit Model "DeSS", 1Room - 2Door, 4Shelf, 2Gas Valve, Caster

DH.DeSS 320Lit Desiccator, Gas-Ex. "DeSS", 1Room - 2Door
Outer : 574×535×h1770mm, Inner : 490×460×h1420mm
Including 4 Shelf, 1 Silica gel Tray, and 2 Gas Valve

Ea.	Price, ₩

(4) 640Lit Model "DeWS", 1Room - 4Door, 8Shelf, 2Gas Valve, Caster

DH.DeWS 640Lit Desiccator, Gas-Ex. "DeWS", 1Room - 4Door
Outer : 1164×535×h1770mm, Inner : 490×460×h1420mm, 2Room
Including 8 Shelf, 2 Silica gel Tray, and 2 Gas Valve

Ea.	Price, ₩

(5) 604Lit Model "DeW4S", 4Room - 4Door, 8Shelf, 8Gas Valve, Caster

DH.DeW4S 604Lit Desiccator, Gas-Ex. "DeW4S", 4Room - 4Door
Outer : 1164×535×h1770mm, Inner : 490×460×h670mm, 4Room
Including 8 Shelf, 4 Silica gel Tray, and 8 Gas Valve

Ea.	Price, ₩

(6) Spare Thermo-Hygrometer and Stainless-steel Shelf

DH.DeSH001 Spare, Stainless-steel Shelf, 20kg Load, 490×460mm
DH.DeDHY , Digital Thermo-Hygrometer, DC, 1~99℃, 11%~99%RH

Ea.	Price, ₩

2-Year Warranty



(3) 320Lit 1Room-2Door



(4) 640Lit 1Room-4Door
(5) 604Lit 4Room-4Door

With Digital Thermo-Hygrometer & Gas Valve



Urea Tray for Desiccant (Silica Gel)

2-Year Warranty



(1) Short Auto-Dry



(2) Tall Auto-Dry

DAIHAN® 33Lit Auto-Dry PMMA Desiccator, Short- & Tall-form, Dehumidifier ~25%RH With ABS Frame · Digital Thermo-Hygrometer, [Korean-made], 자동 습도 조절 테시케이터

- **Excellent Viewing & Air Tight Structure ; Heavy-duty ABS(Acrylonitrile Butadiene Styrene Resin) Frame, 3mm Clear PMMA(Polyethyl Methacrylate Resin) Body Panel & 5mm Shelf, and Rubber Sealing Door.**
- * Adjustable Shelf Quantity & Height / Distance.
- * 2kg Shelf Load. * 30mm Shelf Moving Interval.
- * Built-In Analog Dehumidifier Unit ; Repeated Regeneration of Solid Silica Gel Improves Dehumidification Capacity.
- * Power Supply : 220V, 50/60Hz, 3Watts.

※ 운임 약 ₩ 6,000 별도!

(1) 33Lit Auto-Dry Short-model "DeADLL", 1-PMMA Shelf

DH.DeADLL Auto-Dry Desiccator, Short-model, 33Lit, "DeADLL"
Outer : 450×330×h350mm, Inner : 400×305×h270mm

Ea.	Price, ₩

(2) 33Lit Auto-Dry Tall-model "DeADLH", 3-PMMA Shelf

DH.DeADLH Auto-Dry Desiccator, Tall-model, 33Lit, "DeADLH"
Outer : 330×330×h480mm, Inner : 270×305×h400mm

Ea.	Price, ₩

DH.DeSH003 Spare, PMMA Shelf, for Short-model, 2kg Load, 397×302×thick 5mm
DH.DeSH002 , for Tall-model , 2kg Load, 267×302×thick 4mm

DH.DeDHY , Digital Thermo-Hygrometer, DC, 1~99℃, 11%~99%RH
DH.DeDHY , (3) Analog Dehumidifier Unit ; ~25%RH



(3) Analog Dehumidifier Unit Included

2-Year Warranty



Analog Control, Digital Display

(2) 320Lit 1Room-2Door (3) 604Lit 1Room-4Door

DAIHAN® 207 · 320 · 604Lit Auto-Dry PMMA Desiccator, Analog or Digital-Control, 15~60%RH With Dehumidifier · Digital ℃ · %RH Meter · Al-Frame · 1Room, [Korean-made], 자동 제습 테시케이터

- **Excellent Auto-Dry / Viewing / Air Tight Structure ; Built-In Dehumidifier 15%~60%RH in Digital Control, Heavy-duty Aluminium Frame, 5mm Clear PMMA Body Panel, Stainless-steel Shelf 20kg Load, Caster, and Rubber Sealing Door.**
- * Analog or Digital Controlled Dehumidifier Unit ; Repeated Regeneration of Solid Silica Gel Improves Dehumidification Capacity. * Included 1-Dehumidifier.
- * Ideal for Sample Storage / precise Instrument / Semiconductive Articles / Low Humidity, Characterization Test, etc.
- * 20kg Shelf Load. * Including 4 Stainless-steel Shelf.
- * Adjustable Shelf Quantity & Height / Distance.
- * Display : Digital Thermo-Hygrometer ; 1~99℃, 11%~99%RH
- * Power Supply : 220V, 50/60Hz

※ 운임 약 ₩ 30,000 별도!

1) 207 · 320 · 604 Lit Analog Control Model, 20%~50%RH

DH.DeADABG1K (1) 207Lit Analog Auto-Dry Desiccator "DeADABG1K"
1Room - 1Door, 4Shelf
Outer : 574×535×h1070mm, Inner : 490×460×h920mm

Ea.	Price, ₩

DH.DeADASS (2) 320Lit Analog Auto-Dry Desiccator "DeADASS"
1Room - 2Door, 4Shelf
Outer : 574×535×h1770mm, Inner : 490×460×h1420mm

DH.DeADAWS (3) 604Lit Analog Auto-Dry Desiccator "DeADAWS"
1Room - 4Door, 8Shelf
Outer : 1154×535×h1770mm, Inner : 490×460×h1420mm



Dehumidification Unit



Digital Thermo Hygrometer

2-Year Warranty



Fully Digital Control

(6) 604 Lit, 1Room-4Door

2) 207 · 320 · 604 Lit Digital Control Model, 15%~60%RH

DH.DeADDBG1K (4) 207Lit Digi. Auto-Dry Desiccator "DeADDBG1K"
1Room - 1Door, 4Shelf
Outer : 574×535×h1070mm, Inner : 490×460×h920mm

Ea.	Price, ₩

DH.DeADASS (5) 320Lit Digi. Auto-Dry Desiccator "DeADDSS"
1Room - 2Door, 4Shelf
Outer : 574×535×h1770mm, Inner : 490×460×h1420m

DH.DeADDWS (6) 604Lit Digi. Auto-Dry Desiccator "DeADDWS"
1Room - 4Door, 8Shelf
Outer : 1154×535×h1770mm, Inner : 490×460×h1420mm

DH.DeSH001 Spare, Stainless-steel Shelf, 20kg Load, 490×460mm
DH.DeDHY , Digital Thermo-Hygrometer, DC, 1~99℃, 11%~99%RH
for (1) "DeADABG1K", (2) "DeADASS", (3) "DeADAWS"



Dehumidification Unit



Digital Control & Thermo Hygrometer

Articles	Cat. No	Description
----------	---------	-------------

2-Year Warranty



(1) Short Auto-Dry



(2) Tall Auto-Dry

DAIHAN® 33Lit UV Protected Auto-Dry PMMA Desiccator, Short- & Tall-model, ~25%RH
 With Dehumidifier · Digital Thermo-Hygrometer · ABS Frame, [Korean-made], UV차단 자동 습도 조절 데시케이터

- Made of Transparent Amber PMMA Panel ; 520nm (or Less) UV Protection.
- Good Viewing / Excellent Auto-Dry / Air Tight Structure ; Heavy-duty ABS Frame, 3mm Transparent Amber PMMA Body Panel & 5mm Shelf, ~25% Dehumidifier Unit, and Rubber Sealing Door.
- * Analog Controlled Dehumidifier Unit ; Repeated Regeneration of Solid Silica Gel Improves Dehumidification Capacity.
- * Adjustable Shelf Quantity & Height / Distance. * 2kg Shelf Load.
- * Power Supply : 220V, 50/60Hz, 3Watts.

※ 운임 약 ₩ 6,000 별도!

(1) 33Lit Short-model "DeADLL.UV", UV Protect / Auto-Dry, 1-PMMA Shelf

DH.DeADLL.UV UV Protect / Auto-Dry Desiccator "DeADLL.UV", Short-model, 33Lit
 Outer : 450×330×h350mm, Inner : 400×305×h270mm

Ea.	Price, ₩
-----	----------

(2) 33Lit Tall-model "DeADLH.UV", UV Protect / Auto-Dry, 3-PMMA Shelf

DH.DeADLH.UV UV Protect / Auto-Dry Desiccator "DeADLH.UV", Tall-model, 33Lit
 Outer : 330×330×h480mm, Inner : 270×305×h400mm

Ea.	Price, ₩
-----	----------

DH.DeSH003 Spare, PMMA Shelf, for Short-model, 2kg Load, 397×302×thick 5mm
DH.DeSH002 , for Tall-model , 2kg Load, 267×302×thick 4mm

DH.DeDHY , Digital Thermo-Hygrometer, DC, 1~99℃, 11%~99%RH
DH.DeHY , (3) Analog Dehumidifier Unit ; ~25%RH



(3) Analog Dehumidifier Unit Included

2-Year Warranty



(1) 7Lit



(2) 9.2Lit

1) Upper Door Model

DAIHAN® 7~48Lit Vacuum PMMA Desiccator, Clear, with Press-Gauge
 With Upper- or Front-Door, Approx - 1 Torr / 133Pa, [Korean-made], 진공 데시케이터

- Permissible Degree of Vacuum ; Approx -1 Torr / 133Pa
- Made of 20 ~ 30mm Clear PMMA Panel, 2 Vacuum Valve, 1 Vacuum Gauge, Silicon & Rubber Sealing Door, Shelf, and 1 Desiccant Tray(270×144×h16mm for 7 / 9.2 / 12 Lit)
- * Two Vacuum Valve φ 8mm
- * 1 Pressure Dial Gauge ; 0Bar ~ 1Bar± 1.5%

※ 운임 약 ₩ 6,000 별도!

1) 7 & 9.2Lit Upper Door / Short-form, 20mm PMMA Panel

DH.DeVS (1) 7Lit Vacu. Desiccator "DeVS", 1Shelf, 1Tray
 Outer : 300×300×h170mm, Inner : 260×260×h100mm

Ea.	Price, ₩
-----	----------

DH.DeVM (2) 9.2Lit Vacu. Desiccator "DeVM", 1Shelf, 1Tray
 Outer : 260×260×h360mm, Inner : 210×210×h210mm

2) 12 · 30 · 48Lit Front Door / Tall-form, 20~30mm PMMA Panel

DH.DeVL (3) 12Lit Vacu. Desiccator "DeVL", 20mm Panel, 2Shelf, 1Tray
 Outer : 310×225×h430mm, Inner : 260×180×h260mm

Ea.	Price, ₩
-----	----------

DH.DeVLH (4) 30Lit Vacu. Desiccator "DeVLH", 25mm Panel,
 4Shelf, 1Tray(190×273×h18mm)
 Outer : 320×335×h600mm, Inner : 260×280×h410mm

DH.DeVW (5) 48Lit Vacu. Desiccator "DeVW", 30mm Panel
 3Shelf, 1Tray(313×230×h20mm)
 Outer : 470×365×h600mm, Inner : 400×300×h400mm



(3) 12Lit



(4) 30Lit

2) Front Door Model



(5) 48Lit



(6) Gas Flowmeter

Gas Flowmeter, for Gas-Ex. Desiccator, 10ℓ/min

DH.DeFL (6) Gas Flowmeter 10ℓ/min, Size 70×170mm
 with Bracket & 2 Fitting for φ 6mm Tubes

Ea.	Price, ₩
-----	----------

NEW



(1)



(2)



(3)

Silica-Gel Blue & White, Good for Desiccant Purification

- DH.7510.1405** (1) Silica-gel Blue, Indicat-5~10mesh, cp, 500g **New**
- DH.7510.1400** (2) , 1kg **New**
- DH.7513.1405** (3) Silica-gel White, 5~10mesh, cp, 500g **New**
- S19.401** (4) , Non-woven Fabric Bag, 20g



(4)

Pk.	Price, ₩
500g	
1kg	
500g	
10ea	

Electrophoresis

Gel Documentation System - Portable	P. 51
- Unified	P. 52
UV Transilluminator	P. 53
Accessory - UV-intensity Meter	P. 53
- UV-indicator	P. 53

Gel Documentation System

Portable Gel Documentation System

“WGD-20”

1.45M Pixel CCD Camera



Gel Imaging System

Built-in Transilluminator

“MaXidoc™ G2”

1.45M Pixel CCD

UV Transilluminator

Standard Case-type

“WUV-L50”



Max. 3,000 rpm

Cat. No	Description	Articles
---------	-------------	----------

DAIHAN® Portable Gel Documentation System “WGD-20”, 1.45M Pixel CCD Camera, with Certi. & Traceability With Digital CCD Camera & Optical Lens, Portable Darkroom Hood, Capture Software, USB Interface
젤이미지 분석 시스템, 고성능/최저가, 디지털 CCD 카메라(145만 화소) 장착



2-Year Warranty

Portable Gel Documentation System “WGD-20”

- **Made in Korea** ■ **CE Certified** ■ **PL(Product Liability) Insurance**
- **with Certificate & Traceability : Controlled by Serial Number, Certificate, Delivery-information, and Traceable Data Base System**
- **The Most Cost-Effective System**
- **High Precise and Large Caliber Optical Lens with Zoom, Focus and Iris Control are Used**

- * DNA, RNA gel Imaging Capture and Analysis
- * Digital CCD Camera (Resolution 1.45 Million pixel) with Portable Darkroom is Offered
- * 1360 × 1024, 10-bit CCD, Available for 8-bit Gray Level Image Capturing
- * Power Consumption : Supplied USB(USB 3.0)
- * Very Compact Portable Darkroom System Enables the Existing Transilluminators in the Lab to be used together with this system. High Flexibility in use is Offered
- * USB 3.0 Interface is available, through which Real-Time Images are transferred directly to PC
- * Software : Easy and Fast Capture of Gel Image
- * TotalLab™ Software : Fully Automatic, Single Button Press Complete Image Analysis in Interesting Area(Optional)

Specifications & Ordering information

Spec.		Model	“WGD-20”	“WGD-20S” Included DNA Analysis S/W
CCD Module	CCD & Pixel Size		1/2" CCD, 4.65 × 4.65 um	
	Max. Resolution		1360 × 1024	
	Lens Mount & Optical Size		C mount, 7.6 × 6.2 mm	
	Connect to PC & Power		USB 3.0, Supplied USB	
Zoom Lens	Iris & Focal Length		F1.0 - Close, 8~48mm	
	Ambient Temp.		-10 °C to +50 °C	
Overall	Dimension & Weight		300 × 260 × h470 mm, 9 kg	
	Software Capability		Windows XP, Vista & 7, 8, 10	
Included Standard S/W			Included MaXidoc™ Gel Imaging Capture Software	
Included DNA Analysis S/W			none	TotalLab™ CLIQS
Packing Size & Weight			400 × 350 × h510 mm, 18 kg	
Cat. No.			DH.WGD00020	DH.WGD00024
Price, Each. ₩				

※ Computer System Requirements

- Intel Chipset, USB 2.0 Support Mainboard
- Over Pentium 4 Processor
- Over 256MB Main Memory
- Over 60MB Space of HDD for Installation and Running
- Window XP, Vista & 7, 8, 10



MaXidoc™ Imaging Capture S/W

: Included S/W, Real-Time Image Viewing/Capture, Manipulate and Save Images



(1) UV Transilluminator(Optional)

* Other Specifications are available upon Customer's Request.

※ **운임 약 ₩ 9,000 별도!**

Optional Transilluminator & S/W

		Ea. Price, ₩
DH.WUV00020	(1) Transilluminator, “ WUV-L20 ”, 20 × 20cm Filter 312nm, 15W UV Lamp × 6ea	
DH.WUV00050	(1) Transilluminator, “ WUV-L50 ”, 20 × 20cm Filter 365nm + 312nm, 15W UV Lamp × 6ea	
DH.WUV00120	(1) Transilluminator, “ WUV-M20 ”, 20 × 20cm Filte 312nm, 8W UV Lamp × 6ea	
DH.WGD00100	(2) DNA/Protein Analysis S/W, TotalLab™ CLIQS	
DH.WGD00121	(3) CLIQS 1D Pro	
DH.WGD00200	LapTop Computer, WGD-Laptop , for WGD Gel Doc.System	

DNA Analysis S/W

(2) TotalLab™ CLIQS

- Automatic and Manual Lane Detection, Background Subtraction
- Fully Automatic Band Detection, Molecular Size / pI Calibration
- Quantity Calibration, Normalization

(3) CLIQS 1D Pro (additional function)

- Match Band Data Patterns across Large Groups of Lanes
- Choice of Algorithms to Generate Dendrograms : NeighborJoining, UPGMA, Complete Linkage, Single Linkage, Ward Library, Queries Function



One Stop Analysis

DAIHAN[®] Gel Imaging System "MaXidoc™ G2", Built-in Transilluminator, 1.45M Pixel, 4.65 μ m, F1.0, 8~48mm Manual Zoom With Capture Software, High-quality CCD Camera & Optical Lens, Auto Control System, USB Connection, Certi. & Traceability
 이미지 분석 시스템, 자외선 발산기 일체형, 디지털 CCD 카메라(145만 화소) 장착



2-Year Warranty

"MaXidoc™ G2" Gel Imaging System,
Built-in Transilluminator



MaXidoc™ Imaging Capture S/W

: Included S/W, Real-Time Image Viewing/Capture, Manipulate and Save Images



Sturdy
Camera Bracket

F1.0, 8~48mm
Manual Lens

Enterfilter

- Made in Korea
- PL(Product Liability) Insurance
- with Certificate & Traceability : Controlled by Serial Number, Certificate, Delivery-information, and Traceable Data Base System.
- Complete System with 1.45M Pixel Digital CCD Camera, Safety Darkroom Hood and Built-in Transilluminator(UV Type or LED Type)
- High-quality F1.0 Optical Lens with 8~48mm Manual Zoom, Focus and Iris Control is Used.
- Included Maxidoc™ Gel Imaging Capture Software.

- * Ideal for Various Applications of DNA, RNA Protein Gel Imaging Capture and Analysis.
- * Unified Darkroom System with Built-in Sliding Transilluminator offers very safety and convenience in use
- * Built-in Single Wave Transilluminator(UV Type) : 312nm, 6×8W UV Lamps and ETI White LED×3Ea
- * Built-in Single Wave Transilluminator(LED Type) : 470nm, Blue LED×324Ea, 35W
- * 1360×1024 CCD Resolution * Can be Used with Tablet PC(Optional)
- * USB 2.0 Interface is Available through Which Real-time Images are Transferred Directly to PC

Specifications & Ordering information

Spec.	Model	"MaXidoc™ G2"	
Transilluminator Type		Standard UV Type	Blue LED Type
Camera Resolution		1.45 Mega Pixel CCD	
Pixel Size		4.65 μ m	
Lens		F1.0 Fixed, 8~48mm Manual Zoom	
Transilluminator		312nm, 6×8W UV Lamps, Filter Size : 210×260mm	470nm, Blue LED×324Ea, Filter Size : 210×260mm
Software		Included MaXidoc™ Gel Imaging Capture Software	
White Light		3×LED Lamps	
PC Interface(OS)		Window7 or Window10 64bit	
Camera Interface		USB 2.0	
Dimension & Weight		360×380×h700 mm, 24 kg	
Packing Size (mm) & Gross Weight (kg)		430×490×h830 mm, 28 kg	
Electric Reqts.		1 Phase, AC 120V, 60Hz or AC 230V, 50/60Hz	

Cat. No.	230V	DH.WGD00300	DH.WGD00310
	120V		DH.WGD00301

Price, Each. ₩

* Other Specifications are available upon Customer's Request.

Optional Software/Transilluminator/White Light Table

DH.WGD00100	(1) DNA/Protein Analysis S/W, TotalLab™ CLIQS	Ea. Price, ₩
DH.WGD00121	(2) , CLIQS 1D Pro	
DH.WUV01110	UV Lamp, 365nm, 8W	
DH.WUV02110	, 312nm, 8W	

DNA Analysis S/W

(1) TotalLab™ CLIQS

- Automatic and Manual Lane Detection, Background Subtraction
- Fully Automatic Band Detection, Molecular Size / pI Calibration
- Quantity Calibration, Normalization

(2) CLIQS 1D Pro (additional function)

- Match Band Data Patterns across Large Groups of Lanes
- Choice of Algorithms to Generate Dendrograms : NeighborJoining, UPGMA, Complete Linkage, Single Linkage, Ward Library, Queries Function



One Stop Analysis

DAIHAN® UV Transilluminator “WUV”, Standard- & Compact Case-type, 48W/90W

With Hinged UV-Blocking Safety Cover, Robust, Versatile, 312 · 365 · 312+365 nm, with Certi. & Traceability

자외선 발산기, 기본형 핵산(DNA, RNA), 스탠다드-/컴팩트-케이스 타입



(1) Transilluminator, Standard Case “WUV-L” Model



(2) Transilluminator, Compact Case “WUV-M” Model

- Made in Korea
- CE Certified
- PL(Product Liability) Insurance
- with Certificate & Traceability : Controlled by Serial Number, Certificate, Delivery-information, and Traceable Data Base System
- Low Cost, Robust, Versatile, Affordable & Gentle Excitation
- Hinged UV-Blocking Safety Cover Protects User from UV Radiation
- Stainless-steel Frame and Robust Steel Housing

* Ideal for Standard Gel Documentation and Preparative Work, especially for Detection of very small amount of DNA & RNA Stained by EtBr
 * Long-Life Electronic (Low Heat, no Flickering) * High (100%) / Low (75%) Intensity Switch

Specifications & Ordering information

Spec.	Model	“WUV-L10”	“WUV-L20”	“WUV-L50”	“WUV-M10”	“WUV-M20”
		Single 365 nm	Single 312 nm	Dual 365+312 nm	Single 365 nm	Single 312 nm
Body Size-type		(1) Standard Case-type			(2) Compact Case-type	
Dimension		495 × 330 × h95 mm			350 × 275 × h95 mm	
Filter Size		200 × 200 mm				
Wave Length		Single 365 nm	Single 312 nm	Dual 365+312 nm	Single 365 nm	Single 312 nm
UV Lamps		15W × 6ea (90W)			8W × 6ea (48W)	
Power Consumption		95 W			52 W	
Weight		10 kg			8 kg	
Packing Size (mm) & Gross Weight (kg)		520 × 380 × h220 mm, 12 kg			380 × 320 × h220 mm, 10 kg	
Electric Reqts.		1 Phase, AC 120V, 60Hz or AC 230V, 50/60Hz				
Cat. No.	230V	DH.WUV00010	DH.WUV00020	DH.WUV00050	DH.WUV00110	DH.WUV00120
	120V	DH.WUV02010	DH.WUV02020	DH.WUV02050	DH.WUV00210	DH.WUV00220
Price, Each. ₩						

* Other Specifications are available upon Customer's Request.

Spare UV Lamp

- DH.WUV01010 UV Lamp, 365nm, 15W, for “WUV-L10/L50”, “UVL365”
- DH.WUV01020 , 312nm, 15W, for “WUV-L20/L50”, “UVL312”
- DH.WUV01110 , 365nm, 8W, for “WUV-M10”, “UVM365”
- DH.WUV02110 , 312nm, 8W, for “WUV-M20”, “UVM312”

Ea. Price, ₩



UV-intensity Meter

Custom® Digital UV-intensity Meter, 1999~19,990 μW/cm²

With UV Sensor, 70 × 25 × h131mm, 335g, 디지털 자외선 강도계

■ Supplied by LMS® in Japan

- * Range (μ W/cm²): 1999 · 19990 * Accuracy: ±(4%rdg+2 dgt)
- * Wavelength Sensitivity Characteristics : 290-390 nm * Sampling : 2.5time/sec
- * Size : Body / 70 × 25 × 131mm, Sensor / 46 × 27 × 168mm, Cord Length / 700mm
- * Measurement of UVA, UVB is Possible
- * Separated Sensor enables you to Measure from Further.

AS1.6395.11 “UV340” Meter, Digital, UV-intensity

Ea. Price, ₩



UV-indicator Dot Label

Jayu® UV-indicator Dot Label, φ 18mm, 자외선 감시 라벨

■ Supplied by LMS® in Japan

- * Original Color → Discoloration : UV-L / Clear(White) → Reddish Brown, UV-M / Clear(White) → Pink, UV-H / Clear(White) → Orange, UV-S / Clear(White) → Red
- * Labels Change Color by UV and keep Remaining Once Discolored.
- * The Back has Special Adhesives so that it can Stick Easily. * Quantity : 1pack (100sheet)

AS6.7789.03 “UV.S” Label UV-indicator Dot, for UV-lamp
 AS6.7789.04 “UV.L” , Solar

Pk. Price, ₩
100ea
100ea

Evaporator Circulator Cooler “Chiller”	P.60
Evaporator Cooler and Vacuum Aspirator	P.61
Rotary Vacuum Evaporator, 0.1 ~ 5 Lit New	P.55~56
, 0.5 ~ 2 Lit	P.57
, 5 · 10 · 20 Lit	P.58
, 50 Lit	P.59

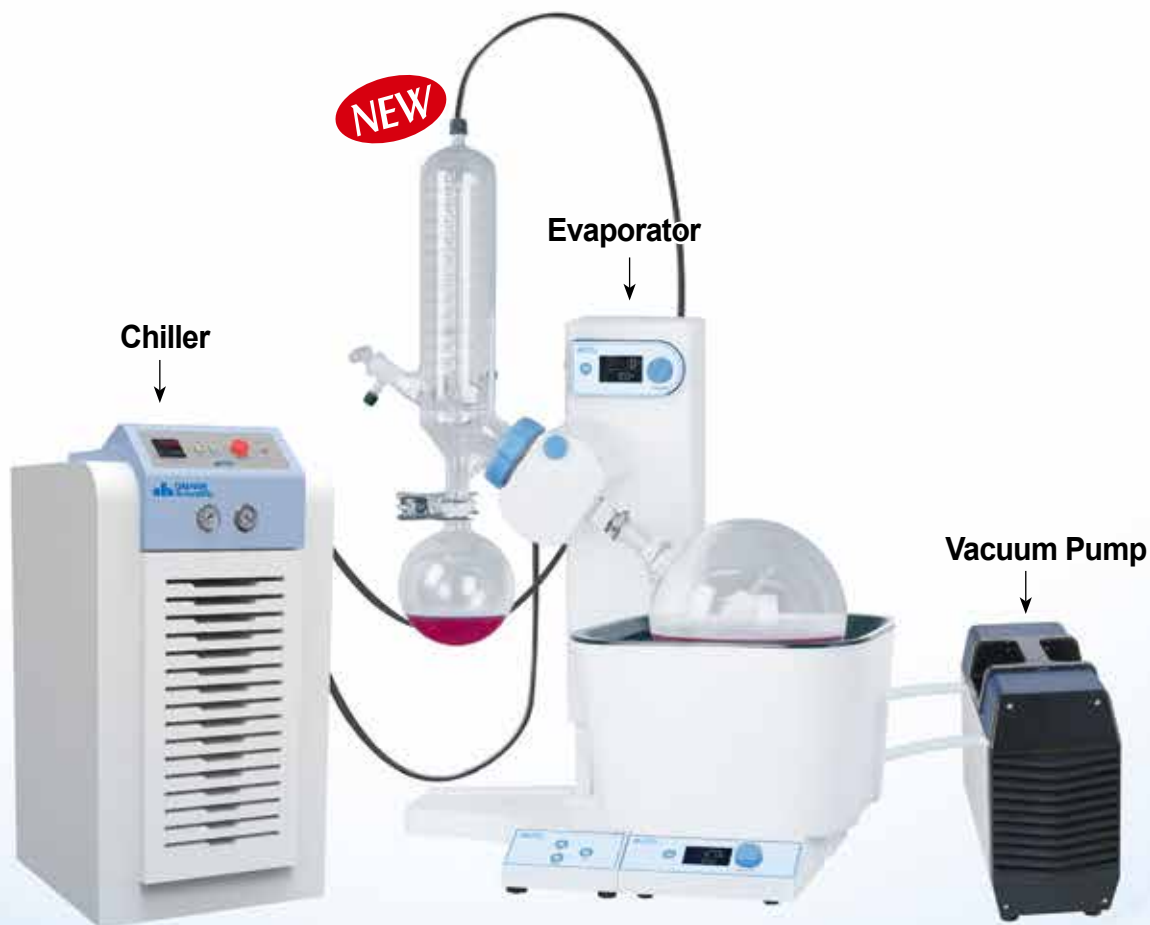

► Installation Figure : 20Lit Evaporator with Chiller & Vacuum Pump

PREMIUM EVAPORATOR Wide-range Capacity "Eva-05"

DAIHAN® PREMIUM Rotary Vacuum Evaporator **NEW** For 0.1~5Lit Evaporating Flasks

Programmable
Electric
Automatic Lifting

Up to 195mm,
Digital Display Height

Adjustable
Immersion Angle
&
Automatic
Reverse Rotation

1,600cm² Vertical High Cooling Capacity

- 1,600cm² Cooling Surface Condenser.
- Superior Evaporation Capacity : 51.6ml/min(Water)

10-Step Adjustable Wide Immersion Angle

Adjustable 10-Step Wide Immersion Angle 1° ~ 50°



Automatic Reverse Rotation

- Rotated Direction of Evaporating Flask Can be Reversed (Clockwise or Counter-Clockwise)
- Programmable Rotation Cycle Time for User Convenience



Interchangeable Detachable Heating Bath

- Separable Bath Structure from Digital Controller for User Safety and Convenience



Possible to Use a Heating Bath by Itself!

Programmable Electric Automatic Lifting



- Adjustable Electric Automatic Lifting :
Up to 195mm to Accommodate Changing Flask
- Programmable Prefer Height
- Digital Display the Height for User Convenience
- Automatic Raising when Power Error for Sample Protection

Individual Digital Control

- Evaporator and Heating Bath have the Individual Digital Control System for User Convenience.
- Heating Bath can be used in Other Applications Widely.



0.1~5.0 Lit Wide Range Capacity

- Designed for Using 0.1~5Lit Evaporating Flasks
Up to 200 °C
- 2.5Lit Oil Bath(Included) : for 0.1~2Lit Flasks
- 5.5Lit Oil Bath(Optional) : for 2~5Lit Flasks



up to 2Lit



up to 5Lit

DAIHAN® 0.1~5Lit **PREMIUM** Rotary Vacuum Evaporator “Eva-05”, Vertical-type, 195mm Auto Lifting **NEW**
 With 2.5Lit Heating Bath(Option 5.5Lit Bath), Up to 200 °C, Cooling Surface 1,600cm², 10-Step Immersion Angle 1°~50°,
 and Automatic Reverse Rotation Function ; Clockwise or Counter Clockwise, 10~300rpm, **프리미엄 회전 진공 농축기**



Premium Rotary Evaporator, with 2.5Lit Oil Bath(Included), for 0.1~2Lit Evaporating Flask

- **Made in Korea** ■ **PL(Product Liability) Insurance**
- **Patented Jog Dial & Touch Button Control System**
- **with Certificate & Traceability : Controlled by Serial Number, Certificate, Delivery-information, and Traceable Data Base System**
- **Ideal for Distilling(Mixed) Solvent, Condensation Solution, and Suspension, Concentrating Liquid, Re-crystallization Dry Powder and Granulate, Synthesizing Chemical, Soxhlet Extraction, etc.**
- **Designed for Using 0.1~5Lit Evaporating Flasks, up to 200 °C**
 - **2.5Lit Oil Bath(Included) : for 0.1~2Lit Evaporating Flasks.**
 - **5.5Lit Oil Bath(Optional) : for 2~5Lit Evaporating Flasks.**
- **Automatic Reverse Rotation Function : Clockwise or Counter Clockwise**
- **Adjustable Wide Immersion Angle : 10 Steps, 1° ~ 50°**
- **No Grease is needed for the Flask Connection of Vapor Duct due to Teflon & Viton O-ring Gasket.**
- * Evaporator and Heating Bath have the individual Digital Control System.
- * Separable Bath Structure from Digital Controller for User Safety and Convenience
- * Embedded Heating Elements for Bath
- * High Cooling Surface Condenser : 1,600cm², 51.6ml/min
- * Adjustable Electric Automatic Lifting : Up to 195mm to Accommodate Changing Flask
 - Programmable Prefer Height
 - Digital Display the Height for User Convenience
 - Automatic Raising when Power Error for Sample Protection
- * Rotary Evaporators can be Set with Circulation Aspirator Pump (P. 61)



Premium Rotary Evaporator, with 5.5Lit Oil Bath(Optional), for 2~5Lit Evaporating Flask

Specifications & Ordering information

Spec.	Model	“Eva-05” 0.1~5Lit Flask
Condenser Type		Vertical-type
Flasks	Evaporating	0.1~5Lit, Included 1Lit Evaporating Flask
	Receiving	0.1~3Lit, Included 1Lit Receiving Flask
Controller & Display		PID Controller, Digital Display
Rotation Speed		10~300rpm
Evaporating Capability		51.6 ml/min
Cooling Surface		1,600cm ²
Heating Bath Capacity & Temp. Range	Standard (Included)	2.5Lit Oil Bath, Up to 200 °C, for 0.1~2Lit Evaporating Flasks External(215×205×h179mm), Internal(197×187×h117mm)
	Optional	5.5Lit Oil Bath, Up to 200 °C, for Max 5Lit Evaporating Flasks External(324×269×h209mm), Internal(305×250×h118mm)
Lifting Type		Adjustable Automatic Electric Lifting : up to 195mm Programmable Prefer Height and Digital Display Height
Immersion Angle		Adjustable 10-step Angle 1° ~ 50°
Vacuum Seal		Double Sealing Rings made of Teflon + Viton Material
Power Consumption		Rotation Motor(100W), Heating Bath : Included 2.5Lit Bath(1,200W/220V, 1,100W/110V), Optional 5.5Lit Bath(1,500W/220V, 1,100W/110V)
Material	Housing	Aluminum Die Casting
	Heating Bath	External(PBT), Internal(Ceramic-coated SUS304)
Dimension & Net Weight		510×438×h519(Max. 714)mm, 16kg
Electrical Reqts.		AC220V, 50/60Hz or AC110V, 60Hz
Cat. No.	230V	DH.Eva0005
	120V	DH.Eva0005.1
Price, Set. ₩		



Optional Oil Bath, 5.5Lit, for 2~5Lit Evaporating Flask

Optional Heating Bath

		Ea. Price, ₩
DH.Bat005	(a) Oil Bath & Base Digital Controller Set, 5.5Lit, Up to 200 °C External(324×269×h209mm, PBT), Internal(305×250×h118mm, Ceramic-coated SUS304) Controller(190×292×h80mm, PBT)	
DH.Bat005.1	(b) Oil Bath Only, without Digital Controller, 5.5Lit, Up to 200 °C, External(324×269×h209mm, PBT), Internal(305×250×h118mm, Ceramic-coated SUS304)	

※ **NOTE!** ▶ **Optional Vacuum Pump for Evaporator : See the “Pump” Section.**
 ▶ **For the Information of Spare Parts : Visit www.DAIHAN-Sci.com Shopping Mall or Contact Us Directly.**

DAIHAN® 0.5~2 Lit Digital Rotary Evaporator “WEV-1001V” & “WEV-1001L”, Vertical & Diagonal-type
 With 6.5 Lit Digital Bath 100°C, PID Control & Lifting Table, 10~180rpm, Cooling Surface 1,300 cm², Certi. & Traceability, 회전식 증발 농축기



2-Year Warranty

(1) Digital Rotary Evaporator, Vertical-type
 “WEV-1001V”, 0.5 ~ 2 Lit



2-Year Warranty

(2) Digital Rotary Evaporator, Diagonal-type
 “WEV-1001L”, 0.5 ~ 2 Lit

- Cooling Surface 1,300 cm²
- with Certificate & Traceability : Controlled by Serial Number, Certificate, Delivery-information, and Traceable Data Base System
- Ideal for Distilling (Mixed) Solvent, Condensation Solution and Suspension, Concentrating Liquid, Re-crystallization Dry Powder and Granulate, Synthesizing Chemical, Soxhlet Extraction, etc.
- Included Two Evaporating Flasks : 1×0.5Lit & 1×1Lit
- The Temperature adopts PID Control, which ensures accurate Temperature Control.
- Speed Display, Operate Visually and easily
- * Digital Speed Display, Digital Temp. Display on Water Bath.
- * Double Sealing with PTFE and Vinton Materials to ensure High Vacuum Degree.
- * The Air Extraction Nozzle of Condenser is set down, and it is Safer after Connection with Vacuum Pipe
- * Building Block Design is Easily to be Extended.
- * Easy Operation of Lifting, Move up and Down Smoothly and Easy to Lock.
- * Dedicated Electric Machinery, Worm and Gear Drive Steadily.
- * The Separation of Bath and the Mainframe makes Configure Flexible.
- * These Rotary Evaporators could Set with Circulation Aspirator Pump (P. 61)

Specifications & Ordering information

Spec.	Model	“WEV-1001V” Vertical-type	“WEV-1001L” Diagonal-type
Condenser Type		Vertical-type	Diagonal-type
Bottle Capacity	Evaporating	Included 2× Evaporating Flasks : 1×0.5Lit & 1×1Lit, Available 100-/250-ml, 2Lit Evaporating Flask(Optional)	
	Receiving	Included 1ea 1 Lit Flask	
Rotary Speed		10 ~ 180 rpm	
Evaporating Capability		20 ml/min	
Cooling Surface		1,300 cm ²	
Achievable Vacuum		399.9Pa(below 3mmHg)	
Bath Capacity		6.5 Lit / φ254×130 mm	
Temp. Range		0°C ~ 100°C	
Functional of Lifting Table		Weight Balancing Gliding Elevating & Manual Lifting	
Elevating Stroke		100 ~ 250 mm	
Vacuum Sealing		Double Sealing Rings made of Teflon + Vinton Materials	
Power Consumption		Motor : 25 W, Heater : 1.05kW	
Controller & Display		PID Controller, Digital display	
Dimension & Net Weight		560×320×h660mm / 9.5 kg	750×320×h540mm / 9.5 kg
Electrical Reqt.s.		AC220V, 50/60Hz or AC110V, 60Hz	
Cat. No.		DH.WEV01001V	DH.WEV01001L
Price, Each. W			

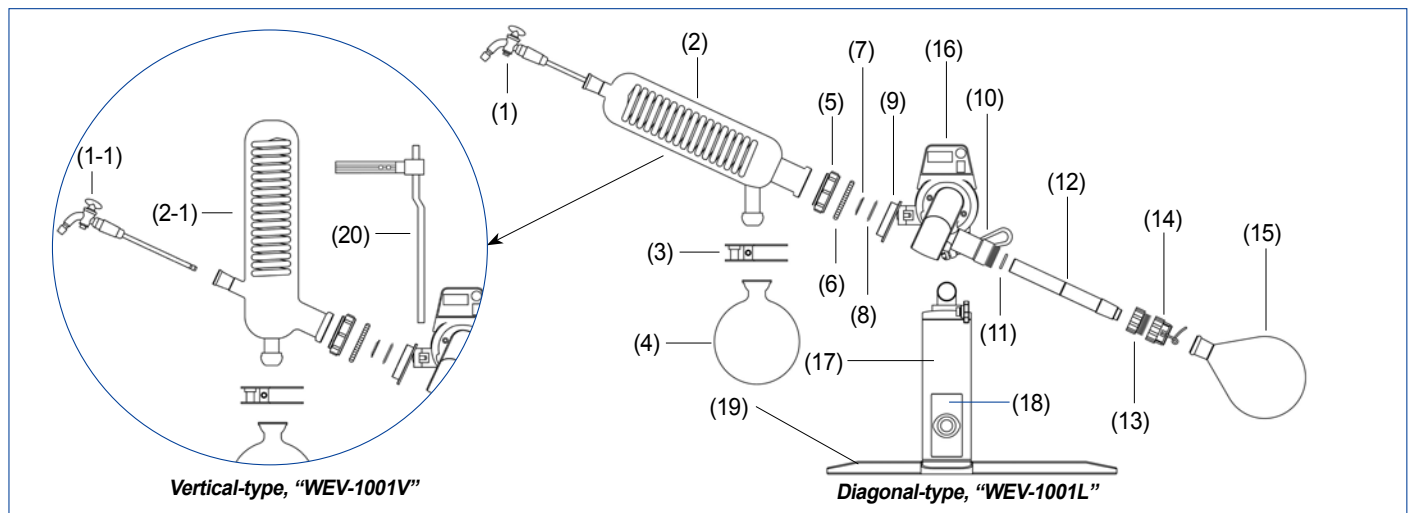

※ **NOTE!** ▶ Optional Vacuum Pump for Evaporator : See the “Pump” Section.
 ▶ For the Information of Spare Parts : Visit www.DAIHAN-Sci.com Shopping Mall or Contact Us Directly.

DAIHAN® 5 · 10 · 20 Lit Digital Rotary Evaporator “WEV-1005 · “WEV-1010” · “WEV-1020”, Large Capacity
 With Digital Controlled Stainless-steel Bath 99°C, Electric Lift Bath, Vertical-type, 20~130 rpm, **대용량 회전식 증발 농축기**



2-Year Warranty

Digital Rotary Evaporator, Large Capa.
 “WEV-1005” 5Lit



2-Year Warranty

Digital Rotary Evaporator, Large Capa.
 “WEV-1010” 10Lit, “WEV-1020” 20Lit

- with Certificate & Traceability : Controlled by Serial Number, Certificate, Delivery-information, and Traceable Data Base System
- Ideal for Distilling (Mixed) Solvent, Condensation Solution and Suspension, Concentrating Liquid, Re-crystallization Dry Powder and Granulate, Synthesizing Chemical, Soxhlet Extraction, etc.
- Teflon (PTFE) and Fluorine Rubber Dual Rotating Seal, Patented Technology to ensure High Vacuum.
- A Vacuum Switching Valve : without Affecting the System Vacuum, Distillation of the Situation and the Solution can be Continuously Collected.
- Electric Lift - Stainless-steel Water Bath, Easy to Use.
- Cooling Surface : “WEV-1005” total 2,700 cm²
 “WEV-1010” total 6,500 cm²
 “WEV-1020” total 11,500 cm²

* Accurate and Reliable Temp. Control due to the Introduction of Advanced Frequency Control System
 * PTFE Discharge Valve, Corrosion Resistance, Pollution-free.
 * Rotary Evaporators can be Set with Circulation Aspirator Pump (P.61)

Specifications & Ordering information

Spec.	Model	“WEV-1005” Evaporating Flask 5Lit	“WEV-1010” Evaporating Flask 10Lit	“WEV-1020” Evaporating Flask 20Lit
Evaporating Flask		5 Lit, Flange Opening ϕ 50 mm	10 Lit, Flange Opening ϕ 95 mm	20 Lit, Flange Opening ϕ 125 mm
Receiving Flask		3 Lit	5 Lit	10 Lit
Condenser		Water Refrigerating	Standing, Main & Auxiliary Cooling and Highly Efficient 3 Circulating Cold Trap	
Temp. Range		0°C ~ 99°C		
Rotary Speed		20 ~ 140 rpm	20 ~ 130 rpm	
Evaporating Capability		Water : 2 Lit/h, Alcohol : 4 Lit/h	Water : 3.2 Lit/h, Alcohol : 6.5 Lit/h	Water : 5 Lit/h, Alcohol : 11 Lit/h
Cooling Surface		Condenser 2,700 cm ²	Main Condenser 4,500 cm ² Auxiliary Condenser 2,000 cm ²	Main Condenser 8,000 cm ² Auxiliary Condenser 3,500 cm ²
Achievable Vacuum		399.9Pa(below 3mmHg)		
Functional of Lifting Table		Electric		
Elevating Stroke		0 ~ 150 mm	0 ~ 160 mm	0 ~ 190 mm
Vacuum Sealing		PTFE and Fluorine Rubber Dual Rotating Seal		
Motor		250 W, Phase DC Induction Motor		
Heating Boiler		Stainless-steel Water Bath		
Display		Digital display		
Power Consumption		2.3 kW	1Phase 220V, 3.8kW or 3Phase 380V, 6.3kW	
Dimension (mm)		835×400×h1090	990×550×h1655	1195×635×h2070
Electrical Reqts.		1Phase 220V, 50/60Hz	1Phase 220V, 50/60Hz or 3Phase 380V, 50Hz	
Cat. No.	230V	DH.WEV01005	DH.WEV01010	DH.WEV01020
	3Phase	-	DH.WEV01011	DH.WEV01021
Price, Each. ₩				

※ 운임 약 ₩ 9,000 별도!

※ **NOTE!** ▶ Optional Vacuum Pump for Evaporator : See the “Pump” Section.
 ▶ For the Information of Spare Parts : Visit www.DAIHAN-Sci.com Shopping Mall or Contact Us Directly.

Cat. No	Description	Articles
---------	-------------	----------

DAIHAN® 50 Lit Digital Rotary Evaporator “WEV-1050”, Large Capacity, Vertical Type, with Electric & Manual Lift Bath With Digital Controlled Stainless-steel Bath 99℃, 20~110 rpm, 19 Lit/h, Cooling Surface 14,500 cm², **대용량 회전식 증발 농축기**



2-Year Warranty

Digital Rotary Evaporator, Large Capa.
“WEV-1050”, 50 Lit

- **Cooling Surface : 14,500 cm²**
- **with Certificate & Traceability : Controlled by Serial Number, Certificate, Delivery-information, and Traceable Data Base System**
- **Ideal for Distilling (Mixed) Solvent, Condensation Solution and Suspension, Concentrating Liquid, Re-crystallization Dry Powder and Granulate, Synthesizing Chemical, Soxhlet Extraction, etc.**
- **Large Capacity & Diameter Rotary Evaporator Flask - 50Lit**
- **Teflon (PTFE) and Fluorine Rubber Dual Rotating Seal, Patented Technology to Ensure High Vacuum.**
- **Stainless-steel Water Bath - Electric & Manual Lift, Easy to Use**
- * The Introduction of Foreign Advanced Frequency Control System, Temperature Control System, Accurate and Reliable.
- * A Vacuum Switching Valve, without Affecting the System Vacuum Distillation of the Situation and the Solution can be Continuously Collected.
- * Water Bath Electric Lift and Manual Lift Support, Easy to Use.
- * PTFE Discharge Valve, Corrosion Resistance, Pollution-free.
- * This Rotary Evaporator could Set with Circulation Aspirator Pump (P.61)

Specifications & Ordering information

Spec.	Model	“WEV-1050”
Evaporating Flask		50 Lit, Flange Opening ϕ 125 mm
Receiving Flask		20 Lit
Condenser		Standing, Main & Auxiliary Cooling and Highly Efficient 3 Circulating Cold Trap
Temp. Range & Rotary Speed		0℃ ~ 99℃, 20 ~ 110 rpm
Evaporating Capability		Water : 9 Lit/h, Alcohol : 19 Lit/h
Cooling Surface		Main Condenser 9,500 cm ² Auxiliary Condenser 5,000 cm ²
Achievable Vacuum		399.9Pa(below 3mmHg)
Functional of Lifting Table & Stroke		Electric & Manual, 0 ~ 180 mm
Vacuum Sealing		PTFE and Fluorine Rubber Dual Rotating Seal
Motor		250 W, Phase DC Induction Motor
Heating Boiler		Stainless-steel Water Bath
Display		Digital display
Dimension (mm)		1345×770×h2140
Electrical Reqts.		6.3 kW, 3Phase 380V, 50Hz
Cat. No.		DH.WEV01050
Price, Each. ₩		

※ **운임 약 ₩ 9,000 별도!**

The Details of Spare Parts for 50 Lit Digital Rotary Evaporator “WEV-1050” models

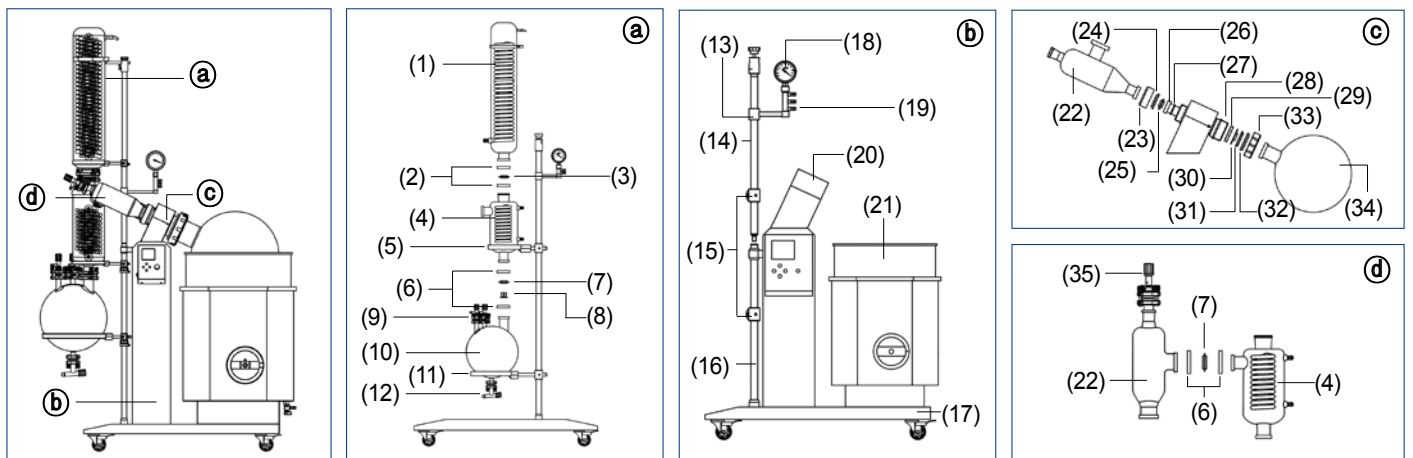

※ **NOTE!** ▶ **Optional Vacuum Pump for Evaporator : See the “Pump” Section.**
▶ **For the Information of Spare Parts : Visit www.DAIHAN-Sci.com Shopping Mall or Contact Us Directly.**

DAIHAN® -20+40°C Chiller "MaXircu™ Chi", Heavy-duty Refrigerated External Circulator, Fill-17 · 29 · 47 Lit
 Ideal for Evaporator/Reactor &c. Cooling Line, Lift 8 · 27m, Cooling Capa 0.87 · 1.3 · 3.0 kW, 다용도 냉각 써클레이터/질러



Max. Filling Volume 29Lit, "MaXircu™ Chi-30"



Assembly-type Safety Connection Ports/Pipe for Fluid In/Out-let ; ISO RC 1/2" Thread, Located On Rear-Upper Panel

- Made in Korea
- PL (Product Liability) Insurance
- with Certificate & Traceability : Controlled by Serial Number, Certificate, Delivery-information, and Traceable Data Base System
- Ideal for Wide-range Reaction System and Evaporator.
- Max. Lift 8 · 27m
- Assembly-type Safety Connection Ports/Pipe for Fluid In/Out-let : ISO RC 1/2" Thread, Stainless-steel.
- Digital PID Control System Implementing Superior Temperature Accuracy.
- Embedded External Nozzle Part for the Prevention of Nozzle Damaged.
- Stainless-steel Internal Bath for Prevention of Corrosion.
- * Wide-range Filling Volume 17Lit · 29Lit · 47Lit
- * Effective Cooling Capacity
- * Useful for 1~50Lit Various Reactors and Evaporators.
- * Emergency Stop Button for safety.
- * High Quality Circulation Pump : 20 · 30 Lit/min Max Flow Rate and 1.0-/3.3-bar Max. Pressure.
- * Built in Pump Pressure Gauge and Compressor Pressure Gauge.

Specifications & Ordering information

Spec.	Model	"MaXircu™ Chi-20" Filling Volume Max. Capa. 17Lit	"MaXircu™ Chi-30" Filling Volume Max. Capa. 29Lit	"MaXircu™ Chi-50" Filling Volume Max. Capa. 47Lit
Temp. Range & Stability	-20°C ~ +40°C-Range, ±0.2°C(at 15°C)-Stability			
Cool-Fluid. Filling Volume	17 Lit max		29 Lit max	
Useful for 1~50Lit Evaporators, etc.	for 1~20Lit Evaporator		for 10~30Lit Evaporator	
Refrigerator Capacity(HP)	1/2 HP		1 HP	
Lid & Top Opening Dia.	∅ 100 mm			
Fluid In/Out-let Connector	ISO RC 1/2" (English System AG 1/2") Thread, Stainless-steel			
Pump Power, Lift Height, m	Max. Flow Rate	20 Lit/min		30 Lit/min
	Max. Pressure & Lift	1.0 bar Max. Lift : 8m		3.3 bar Max. Lift : 27m
Cooling Capacity	at +20°C	1.7 kW	2.8 kW	6.5 kW
	at 0°C	0.87 kW	1.3 kW	3.0 kW
	at -20°C	0.32 kW	0.45 kW	1.2 kW
External Dimension	450×650×h900 mm	580×800×h1260 mm	670×900×h1450 mm	
Material	Internal : Stainless-steel, External : Powder Coated steel			
Electrical Reqts.	1 Phase 230V, 50 / 60 Hz		3Phase 380V	
Cat. No.	60Hz	DH.Chi0020	DH.Chi0030	DH.Chi0050
	50Hz	DH.Chi0025	DH.Chi0035	DH.Chi0055
Price, Each. ₩				

* Other Specifications are available upon Customer's Request.

※ 운임 약 ₩ 20,000 별도!

- ※ See page 37 for the Cooling/Heating Transfer Fluid & Circulation Hose ;
- ▶ Thermanol D12® - 85+230°C Cooling/Heating Transfer Fluid
- ▶ SYN THERM 22L® - 5+320°C Heating Transfer Fluid
- ▶ Insulated External Circulating Tubing

※ Note : Cooling Transfer Fluid Should be an Antifreezing Solution



▶ Figure : One of the Applications in the Large Volume Evaporator Line.

DAIHAN® -35+150°C Digital Precise Refrigerated/Heating Bath Circulator “MaXircu™ CL”, ±0.2°C

With Flat Lid, Digital Fuzzy Control, CFC-free, Certi. & Traceability, 8 · 12 · 22 · 30 Lit, Flow 25Lit/min, Lift 4m

Ideal for Cooling/Heating Line of Facility, External/Internal Circulating Connect - od.12 & id.10mm, 정밀 냉동/가열 배스 겸용 써클레이터



2-Year Warranty

-35°C ~ +150°C Refrigerated / Heating Bath Circulator

- Made in Korea
- CE Certified
- PL(Product Liability) Insurance

Specifications & Ordering information

Spec.	Model	MaXircu™ CL-8	MaXircu™ CL-12	MaXircu™ CL-22	MaXircu™ CL-30
		Max. Capa. 8 Lit	Max. Capa. 12 Lit	Max. Capa. 22 Lit	Max. Capa. 30 Lit
Temp. Range & Accuracy		-35°C ~ +150°C, ±0.1°C			
Temp. Resolution		0.1°C-Display, 0.1°C-Control			
Temp. Uniformity & Probe		±0.2°C at -20°C, PT100			
Pump		Max Flow Rate : 25Lit/min(Controlled 5 Steps Flow Rate Speed), Max Pressure : 7.5 psi, Max Lift : 4m			
Bath Volume		8 Lit	12 Lit	22 Lit	30 Lit
Heating Power		1 kW	1.5 kW	2 kW	2.2 kW
Refrigerator		1/2HP	1/2HP	7/8HP	1HP
Cooling Capacity	at +20°C	500 W	530 W	860 W	1030 W
	at 0°C	340 W	370 W	620 W	760 W
	at -20°C	200 W	210 W	400 W	500 W
Refrigerant		CFC -Free(R-404A) Refrigeration System			
Total Power Consumption		1.7 kW	2.2 kW	3 kW	3.3 kW
Compressor Control		Intelligent Control of Refrigerator for preventing Compressor Overload			
External Circulation Nozzle		id.10.5 / od.12.5mm(For Inner Circulat. : to Connect directly the in-/outlet Nozzles)			
Timer & Alarm		99hr 59min (Delay & Continuous run), Error status & Timer-end			
Display		Digital LCD with Back-Light Function			
Controller		Digital Fuzzy Controller with Jog-Dial Knob (Turn+Push)			
Safety Circuit		Over-Temp./-Current protection, Sensor Error Detection, Leakage Breaker			
Material		Stainless-steel (#304)-Internal, Powder Coated steel-External, 40 mm Thickness Urethane Foaming - Insulation			
Lid & Drain Valve		included Stainless-steel Flat Lid, Ball Valve, Optional Dome Lid			
Dimension (w×d×h)	Effective Space (mm)	175×153×150	230×181×150	290×220×200	330×290×200
	Internal (mm)	175×320×150	230×350×150	290×390×200	330×460×200
	External (mm)	400×523×807	400×523×807	483×563×850	494×633×906
Packing Size (mm)		530×630×985	530×630×985	615×670×1025	630×740×1075
& Gross Weight (kg)		50 kg	55 kg	65 kg	78 kg
Electrical Reqts.		1 Phase, AC 120V, 60Hz or AC 230V, 50 / 60Hz			
Cat. No.	230V	DH.WCL00408	DH.WCL00412	DH.WCL00422	DH.WCL00430
	120V	DH.WCL00508	DH.WCL00512	DH.WCL00522	DH.WCL00530
Price, Each. ₩					

* Other Specifications are available upon Customer's Request.

※ 운임 약 ₩ 16,000 별도!

※ See page 37 for the Cooling/Heating Transfer Fluid & Circulation Hose ;

▶ Therminol D12® -85+230°C Cooling/Heating Transfer Fluid

▶ SYN THERM 22L® -5+320°C Heating Transfer Fluid

▶ Insulated External Circulating Tubing

※ Note : Cooling Transfer Fluid Should be an Antifreezing Solution

※ See the “Bath Circulator” Section for the Details

DAIHAN® Multiuse Water Jet Vacuum Pump/Aspirator “WEV”, 0.098MPa/20mbar

Ideal for Evaporator 1~50 Lit, with Multi-Taps/Safety Valve, Bath 15 & 57 Lit, 다용도 아스피레이터, 워터젯 진공펌프



2-Year Warranty

(1) “WEV-003S” ideal for 1~5Lit Evaporator



2-Year Warranty

(2) “WEV-0095” ideal for 5~50Lit Evaporator

- Resist Corrosion by Acid, Alkali and Solvents.
- Cyclically use Water
- Good for Evaporation, Distillation, Crystallization, Drying, Sublimation, Filtration &.
- Fluorine Rubber Sealing
- Need to Replace the Water in the Flume Regularly

* Can be used alone or in Parallel - WEV-003S(2 Tap & 2-Display), WEV-0095(5 Tap)

* Stainless-steel(#304) Body, Copper Ejector, Tee Junction, PP Back Valve, STS Impeller(WEV-0095)

Spec.	Model	(1) “WEV-003S”	(2) “WEV-0095”
		Ideal for 1~5Lit Evaporator	Ideal for 5~50Lit Evaporator
Max. Vacuum Degree		0.098 Mpa (20mbar)	
Pump Power & Water Bath Volume		180W & 15Lit	550W & 57Lit
Flow Rate		80 Lit/min	100 Lit/min
Taps & Air Sucking Amount		2 Tap, 10 Lit/min (1 Tap)	5 Tap, 10 Lit/min (1 Tap)
External Circulation Nozzle		id. 5/od. 10mm (id. 8/od.11 mm Silicon tube Connected for Circulation)	
Safety Function		Safety Check Valve	
Drain Pipe		id. 15mm	id. 24.3mm
Material of Water Tank / Body		PP / PP	PE / Stainless-steel(#304)
Dimension & Net Weight		385×280×h420 mm / 11 kg	450×350×h820 mm / 36 kg
Electric Reqts.		230V, 50/60Hz	
Cat. No.		DH.WEV0003S	
Price, Each. ₩		DH.WEV0095	

DAIHAN Scientific

Freeze Dry System “UniFreez™ FD”

Lab Scale Bench-top Freeze Dryer

Patented Jog-Dial & Touch-Button Control

Compact-size Lab Scale Bench-top Type

Fastest Freezing Time

Ergonomic & Compact Body

- Lab Scale, Bench-top Type Model
- Compact size for all laboratory table
- Ergonomic Design

Company	DAIHAN	Competitor
Chamber Capacity	8 Lit	8 Lit
External Dimension (mm)	w400×d530×h415	w500×d646×h976

Various Installing Accessory

- Used with 12-port Manifold or 8-port Dry Chamber, Various Size Flasks, Flask Top, Vacuum Valve, Vacuum Pumps, Table Cart etc.



12-port T-type Manifold



8-port Acrylic Dry Chamber

Intuitive User Interface

- Patented Jog-Dial Controller(Turn and Push)
- Capacitive Touch Button for user convenience
- Precise control by microprocessor
- Digital Back-Light LCD



Fastest Freezing System

- DAIHAN Freezing System realizes Quick Freezing and Quick Defrosting Function

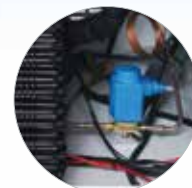

Freezing System

16Lit Chamber Coming Soon!

Others

- High Sublimation Rate : 3 & 6 Lit/24hr
- Manual Defrost Function : Hot Gas Defrost Function for quick next cycle turn-around
- Automatic or Manual Process Control
- Controllable temperature, vacuum and timer at Automatic Mode
- LED Indication Light On in case of suitable temperature and vacuum
- Can be Used with Various Accessories

Freezing speed comparison with Competing Product

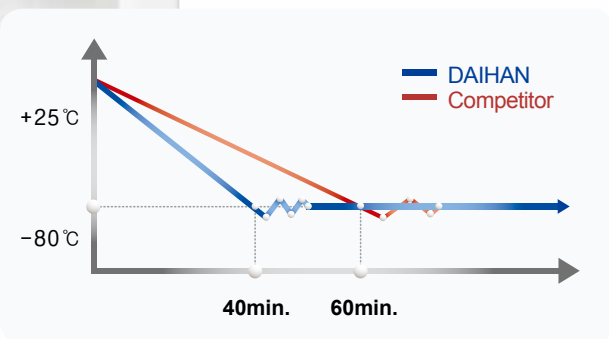

DAIHAN® Freeze Dry System Lab Scale Benchtop-type “UniFreez™ FD”, 3 · 6Lit/day, -90°C

With Automatic & Manual Process, Used with 12-port T-type Manifold or 8-port Acrylic Drying Chamber, 실험실용 동결 건조기

Optional
12-port T-type
Manifold**2-Year Warranty**

3Lit/day “FD-8” Freeze Dryer,
with Optional 12-port T-type Manifold
and 12 Vacuum Handle Valve

- Made in Korea ■ Patented Jog-Dial & Touch Button Control System
- with Certificate & Traceability : Controlled by Serial Number, Certificate, Delivery-information, and Traceable Data Base System ■ PL (Product Liability) Insurance
- Ideal for Wide Range from Pharmaceuticals, Biology, Food Industry to Petro-Chemistry and Semiconductor Industry, etc.

- * Ergonomic Design and Compact Body Size for All Laboratory Tables
- * Allows Automatic or Manual Process Control
- * LCD Indicates Temperature and Vacuum
- * Rapid Integrated Hot Gas Defrost Function for Quick Next Cycle Turn-around
- * LED Indication Light On in Case of Suitable Temperature and Vacuum
- * Can be Controlled Temperature and Timer at Automatic Mode
- * Homogeneous Temperature Distribution across all Shelves in Dry Chamber

Specifications & Ordering information

Spec.	Model	“UniFreez™ FD-8”	Coming Soon “UniFreez™ FD-16”
Sublimation Rate(Lit / day)		3Lit / day	6Lit / day
Chamber & Max Condenser Capa.		Chamber : 8 Lit, Condenser : 10 Lit	Chamber : 16 Lit, Condenser : 20 Lit
Set Temperature Range		-90 ~ -60°C	
Compressor & Defrost-type		1/2 HP, Manual	3/4 HP, Manual
Display		Digital LCD with Back-Light Function	
Material		Stainless-steel(SUS304)	
Dimension(w×d×h) & Weight		Exterior : 450×594×h480 mm, Condenser : φ300×h150 mm, Net Weight : 55 kg	Exterior : 500×620×h600 mm, Condenser : φ300×h300 mm, Net Weight : 60 kg
Electrical Reqts.		1 Phase, AC 120 V, 60 Hz or AC 230 V, 50 / 60 Hz	
Cat. No.	230V	DH.Frd00208	DH.Frd00216
	120V	DH.Frd00108	DH.Frd00116
Price, Each. ₩			

* Other Specifications are available upon Customer's Request.

Optional Accessory for Freeze Dryer

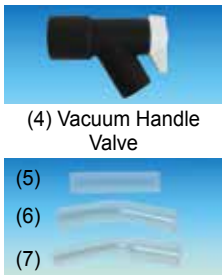
(1) 12-port T-type
Manifold(2) 8-port Acrylic
Dry Chamber(3) 3-stage Shelf,
Stainless-steel(4) Vacuum Handle
Valve
(5) Tube Adapter
for Connecting Flask Top

(8) Flask Top, Silicone



(9) Glass Flask



(10) Vacuum Pump



(11) 2-stage Table Cart

Optional 12-port T-type Manifold / 8-port Acrylic Dry Chamber / 3-stage Shelf

- DH.Frd01034 (1) T-type Manifold, 12-port, for Connecting 3/4" Vacuum Handle Valve, with Silicon Stopper
- DH.Frd02010 (2) Acrylic Dry Chamber, 8-port, for Connecting 3/4" Vacuum Handle Valve, with Silicon Stopper
- DH.Frd02020 (3) 3-stage Shelf, Stainless-steel(STS), for Acrylic Dry Chamber

Ea. Price, ₩

Optional Vacuum Handle Valve-/Tube Adapters-for Connecting Flask

- DH.Frd03010 (4) 3/4" Vacuum Handle Valve, Neoprene Rubber & PP, for Connecting Flask
- DH.GL28091 (5) 3/4" Glass Tube Adapter, φ 19/1.8t×L80mm for Connecting Middle & Large-size Flask Top
- DH.GL28092 (6) 3/4" Glass Bend-type Tube Adapter, φ 19/1.8t×L80mm, for Connecting Middle & Large-size Flask Top
- DH.Frd04010 (7) 3/4" PP Tube Adapter, φ 19/1.8t×L80mm, for Connecting Small-size Flask Top

Ea. Price, ₩

Optional DURAN® Borosilicate α 3.3 Glass Flasks / Silicone Flask Top

- DH.Frd05010 (8) Flask Top, Silicone, 3/4" Small-size Flask Top, for 40-/80-ml Flask
- DH.Frd05020 , 3/4" Middle-size Flask Top, for 200-/300-ml Flask
- DH.Frd05030 , 3/4" Large-size Flask Top, for 500-/700-/1000-ml Flask
- DH.GL12041 (9) Glass Flask, DURAN® Glass α 3.3, 40ml , φ40/2.3t×h80mm
- DH.GL12042 , 80ml , φ40/2.3t×h120mm
- DH.GL12043 , 200ml , φ65/2.2t×h100mm
- DH.GL12044 , 300ml , φ65/2.2t×h140mm
- DH.GL12045 , 500ml , φ90/2.5t×h125mm
- DH.GL12046 , 700ml , φ90/2.5t×h165mm
- DH.GL12047 , 1000ml, φ90/2.5t×h225mm

Ea. Price, ₩

Optional Vacuum Pumps / 2-stage Table Cart for Vacuum Pump

- V3.VOP100.FRD (10) Vacuum Pump, “VOP-100”, 100/120Lit./min, NW25, 220V
- V3.VOP150.FRD , “VOP-150”, 150/180Lit./min, NW25, 220V
- DH.Frd06025 NW25 Vacuum Pump Connection-set, Tube / O-ring / Clamp
- DH.Frd06016 NW16 Vacuum Pump Connection-set, Tube / O-ring / Clamp / Adapter
- DH.Ca1002 (11) 2-stage Table Cart for Freeze Dryer & Vacuum Pump, with Stop-on Caster and Vacuum Pump Oil Tray, w504×d604×h780mm

Ea. Price, ₩

Fume Hood

Ductless - Clean Bench, Laminar Flow	P. 65~66
Ducted - Premium Fume Hood	P. 67
- PP Fume Hood	P. 68
- PP & PVC Wet Scrubber Fume Hood	P. 69



Ductless Clean Bench, Laminar Flow
"MaXtream™ V12"



Ducted Premium Fume Hood
"HD-1500G"



Ducted PP Fume Hood
"HD-1500"



Ducted PP & PVC Wet Scrubber Fume Hood
"HD-1500S"

Fume Hood, Clean Bench-Ductless

Maximum Convenience by Advanced Digital Technology

DAIHAN Hi-performance Fume Hood, Laminar Flow Clean Bench MaXtream™



The Laminar Flow Clean Bench from DAIHAN Scientific provides reliable protection for samples and work processes against particulate contamination.

The air from above the cabinet vertically goes through a **Pre-filter and a Class 100 HEPA Filter** of efficiency up to 99.97% & 0.3 micron size and is exhausted to the front opening for maintenance of Contamination-Free in the cabinet. Also **UV Lamp** installed in the cabinet contributes to sterilize a source of contamination.

The Controller, fully optimized for convenience in the practical use of Clean Bench, offers intuitive monitoring and easy controlling of UV Lamp, Fluorescent light, Filter Fan and air flow speed.

Added to the Unique User Convenient features of DAIHAN, Laminar Flow & Cleanliness, the core performance of Laminar Flow Clean Bench is innovated to be a new Design.

Experiencing the **Max Convenience** and Cleanliness, **MaXtream™** Clean Bench is necessary to have but no more.

»» Key Features

- Design with the consideration of Safety, Convenience and Functionality
- Class 100 HEPA Filter with Pre-filter & Vertical Air Flow : Efficiency up to 99.97% Filtration for 0.3 micron sized particle
- Easy to change HEPA filter design, even without servicing.
- Tempered Glass with Sash Door & Double Door Closing Detection : Perfect Safety against UV (Automatic turn-off of UV lamp when door opens)
- 8 Step Control of Air Flow Speed and Timer function
- 2 × Internal Electrical Outlet, 2 × Valve for External Gas Connection, Fluorescent Lamp

»» Class 100 HEPA Filter

Efficiency up to 99.97% filtration for 0.3 micron sized particle.
Easy to change HEPA filter design, even without servicing.

»» UV Lamp

Built-in UV Lamp Contributes to sterilize a source of contamination in the cabinet. Automatic turn-off of Fluorescent lamps while UV lamps on: Prevention from an accident (damage on samples or a burn) by performing experiment while UV lamps on.

»» Convenience to operate

2 × Internal Electrical Outlet for other electrical devices connection (220 Voltage)
2 × Valve for External Gas Connection.

»» Capacitive Touch-Button Controller

Intuitive Touch-Button Controller for user convenience.
Precise Control by Microprocessor and 8 Step Control of Air Flow Speed by simple Touch. Timer for UV Lamp operation.

»» Various Product Size

Various Sized Laminar Flow Clean Bench : 1200-/1500-/1800mm



DAIHAN® Vertical Clean Bench / Filtered PCR Cabinet “MaXtream™ V”, Class 100 HEPA filter

With 8 Steps Air Velocity Control, Touch-type Controller, Dual UV Lamp and Florescent Lamp, Air and Gas Cock, Built-in Electrical Outlet
 크린벤치 & PCR케비닛, 수직 기류형, 터치식 컨트롤러, 8 단계 풍속 조절, UV 프로텍션 시스템



2-Year Warranty

Vertical Clean Bench and Filtered PCR Cabinet
 “MaXtream™ V12”

- Made in Korea
- CE Certified
- PL (Product Liability) Insurance
- with Certificate & Traceability : Controlled by Serial Number, Certificate, Delivery-information, and Traceable Data Base System
- Class 100 HEPA Filter of efficiency up to 99.97% & 0.3 micron size
- Mesh Guard for HEPA Filter Protection
- Easy to Exchange HEPA Filter
- 8 Steps Air Velocity Control
- Safety UV Protection System :
 UV Lamp is only activated once safety Glass Door is Completely closed
- High performance of Touch Controller-Easy to use
- Microprocessor Digital Controller and Back Light LCD
- UV and Florescent Lamp, External Gas Connection Valve, Internal Electrical outlet
- * High-Quality Back-Light LCD
- * 99hr 59min Timer
- * Silence and Vibration-Free Blower
- * Tempered Safety Glass Sliding Door for Protection from Against UV
- * Optimized Air Flow System for Uniform Air Flow/Velocity
- * Corrosion Resistant 304 Stainless-steel Working table
- * Air Flow-type : Vertical Air Flow-type

Specifications & Ordering information

Spec.	Model	“MaXtream™ V12” Length. 1200	“MaXtream™ V15” Length. 1500	“MaXtream™ V18” Length. 1800
Air Flow-type		Vertical Air Flow-type		
Dimension (w×d×h)(mm)	Interior	1,200×660×610	1,500×660×610	1,800×660×610
	Exterior	1,280×735×1,895	1,580×735×1,895	1,880×735×1,895
Air Volume		1,350 m ³ /h	1,700 m ³ /h	2,020 m ³ /h
Air Flow Velocity		8 Steps, 0.3 ~ 0.6 m/s		
HEPA Filter		Class 100, 0.3 μ m Particle Removal 99.97%		
Prefilter		3~30 μ m Particle Removal		
Display		Back Light LCD		
Controller		Microprocessor Digital Controller with Touch UI		
Lamp		1×UV 20W, 1×FL 36W	1×UV 30W, 1×FL 55W	
Noise Level		Under 65dBA		
Door Type		Tempered Safety Glass Sliding Door		
Utility Device		1×Air Cock, 1×Gas Cock, 2×220V Outlet		
Material		Internal : Stainless-steel(# 304), External : Powder Coated steel		
Electric Reqts.		1 Phase, AC 120 V, 60 Hz or AC 230 V, 50 / 60 Hz		
Cat. No.	230V	DH.WLCV1200	DH.WLCV1500	DH.WLCV1800
	120V	DH.WLCV1201	DH.WLCV1501	DH.WLCV1801
Price, Each. ₩				

* Other Specifications are available upon Customer's Request.

※ 운임 약 ₩ 95,000 별도!



Vertical Air Flow of “MaXtream™ V” model



High-performance Digital Touch-type Controller, Easy to Use

DAIHAN® Premium Ducted Fume Hood, (A) Bypass or (B) Air Curtain-Type, 1200 · 1500 · 1800 · 2400 mm With Phenol Work Top, Phenol Plate Interior, Air-/Gas-/Water-Cock, Cup Sink, Drain, and Explosion Proof Lamp 닥트형 흡후드, Phenol 재질의 작업대, 우수한 내습/내구성, 일반 배기형 or 에어커튼형의 선택성

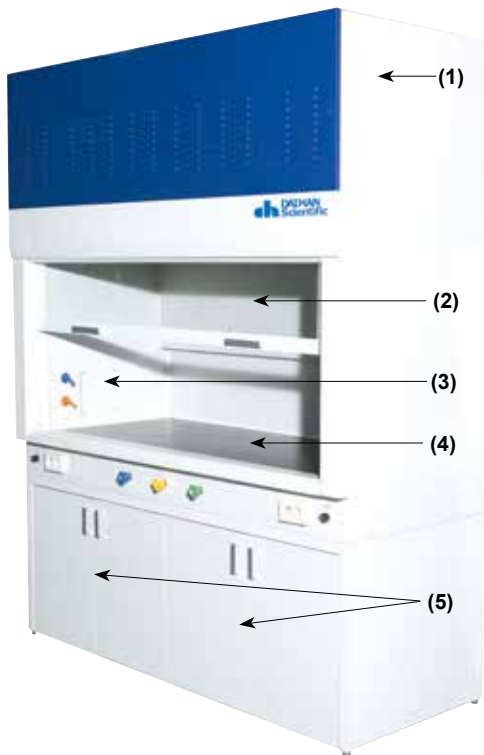

Premium Ducted Fume Hood "HD-1500G"

- Made in Korea
- Durable, Hazardous Chemical Gas Remove.
- Slide Type Sash Door with Tempered Safety Glass.
- Sash-type Tempered Safety Glass Window.

- * General Chemical Gas Hood with High Thermal, Chemical Resistance, Various Material for User selection.
- * With Air-/Gas-/Water-Cock, Cup Sink, Drain, Explosion Proof Lamp, Receptacle, Multi-purpose Cabinet.
- * **By Pass Air Flow-type** : After the Suction Forcing the Indoor Air to Discharge the Gas to the Outside
- * **Air Curtain Air Flow-type** : The Outdoor Air Sucked Form the Air Curtain to the Front Chamber, and the Exhaust Gas Back to Suction the Air
- * Discharging the Polluted Air and Toxic Gas Generated during the Experiment in a Laboratory to the Outside through the Duct Structure
- * Process Pipe & Duct Silicon Sealing to Completely Block the Gas Leakage to the Outside
- * The Mechanical Design is Manufactured with Superior Workability

Specification

Models & Air Flow-type	(A) By-Pass Air Flow-type			
	"HD-1200G"	"HD-1500G"	"HD-1800G"	"HD-2400G"
Duct Size	(B) Air Curtain Air Flow-type			
	"HD-C1200G"	"HD-C1500G"	"HD-C1800G"	"HD-C2400G"
Duct Size	φ 200mm		φ 250mm	
Material*	(1) External : Powder Coated Steel, (3) Internal : Phenol Plate, (4) Work Top : Phenol Plate			
Sash Frame & Window	PVC Sheet Frame, (2) Tempered Safety Glass Sash Window			
Cabinet	(5) Built in Multi-purpose Cabinet			
Lamp	LED Lamp(1ea × 20 W)			
Cock	1ea × Air-/Gas-/Water-Cock			
Receptacle	2ea 220V Concent or 2ea 110V Concent			
Dimension (w × d × h) (mm)	1200 × 800 × 2350	1500 × 800 × 2350	1800 × 800 × 2350	2400 × 800 × 2350
Power Supply *	1 Phase, AC 220V / 60Hz			

* Other Specifications(50Hz) are available upon Customer's Request.

Diagram of Air Flow Depending on the Safety Window Opening

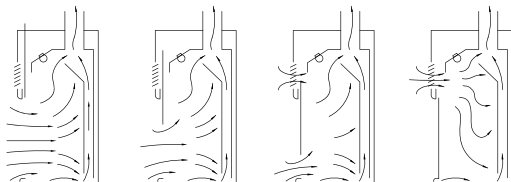

Opening → Closing

(A) By-Pass Air Flow-type

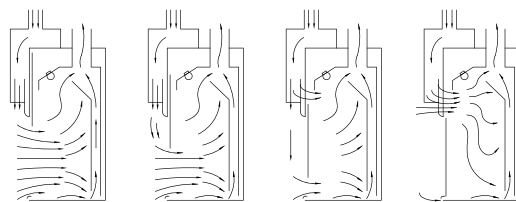

Opening → Closing

(B) Air Curtain Air Flow-type

Welcome! Custom-Made Fume Hood!!

We can Offer DAIHAN Custom Fume Hood, for which you can Specify the Specification

Selectable Material of Custom-Made Fume Hood

	Material			
	Steel	Stainless	P.P	
Exterior	Steel	Stainless	P.P	
Interior	Penol	Stainless	P.E	
Work Top	Penol	Stainless	P.E	Granite

Ordering Information

(A) By-Pass Air Flow-type Ducted Fume Hood

- | | |
|-------------|---|
| DH.WHD02312 | Fume Hood, 230V, 1200 × 800 × h2350mm, "HD-1200G" |
| DH.WHD02315 | , 1500 × 800 × h2350mm, "HD-1500G" |
| DH.WHD02318 | , 1800 × 800 × h2350mm, "HD-1800G" |
| DH.WHD02324 | , 2400 × 800 × h2350mm, "HD-2400G" |
| DH.WHD01312 | Fume Hood, 120V, 1200 × 800 × h2350mm, "HD-1200G" |
| DH.WHD01315 | , 1500 × 800 × h2350mm, "HD-1500G" |
| DH.WHD01318 | , 1800 × 800 × h2350mm, "HD-1800G" |
| DH.WHD01324 | , 2400 × 800 × h2350mm, "HD-2400G" |

Ea. Price, ₩

(B) Air Curtain Air Flow-type Ducted Fume Hood

- | | |
|-------------|--|
| DH.WHD02412 | Fume Hood, 230V, 1200 × 800 × h2350mm, "HD-C1200G" |
| DH.WHD02415 | , 1500 × 800 × h2350mm, "HD-C1500G" |
| DH.WHD02418 | , 1800 × 800 × h2350mm, "HD-C1800G" |
| DH.WHD02424 | , 2400 × 800 × h2350mm, "HD-C2400G" |
| DH.WHD01412 | Fume Hood, 120V, 1200 × 800 × h2350mm, "HD-C1200G" |
| DH.WHD01415 | , 1500 × 800 × h2350mm, "HD-C1500G" |
| DH.WHD01418 | , 1800 × 800 × h2350mm, "HD-C1800G" |
| DH.WHD01424 | , 2400 × 800 × h2350mm, "HD-C2400G" |

Ea. Price, ₩

Optional Blower

- | | |
|-------------|-------------------------------|
| DH.WHD10020 | Integrated Blower, "HDBL0020" |
| DH.WHD10021 | External Blower, "HDBL0021" |

Ea. Price, ₩

- ※ Custom-Made Fume Hood : Wide Variety of Material for User Selection.
- ※ Note! Freight and Installation Charges Separately.

DAIHAN® Ducted PP Fume Hood for Acid / Chemical Resistance, 1200 · 1500 · 1800 · 2400 mm

(A) Bypass or (B) Air Curtain-Type, with Air-/Gas-/Water-Cock, Cup Sink, Drain, and Explosion Proof Lamp

내산 / 내약품용 덕트형 PP 흡후드, PP 재질의 외부/내부/작업대, 일반 배기형 or 에어커튼형의 선택성

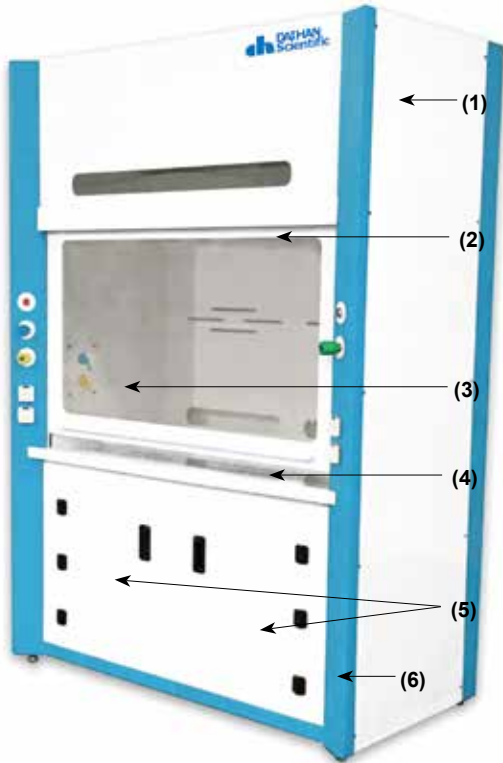

Ducted PP Fume Hood "HD-1500"

Diagram of Air Flow Depending on the Safety Window Opening

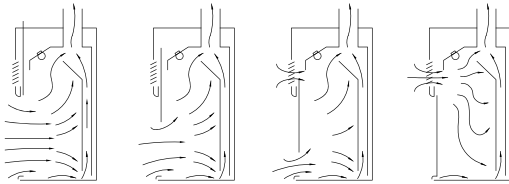

Opening → Closing

(A) By-Pass Air Flow-type

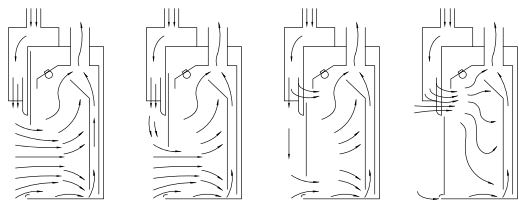

Opening → Closing

(B) Air Curtain Air Flow-type

Welcome! Custom-Made Fume Hood!!

We can Offer DAIHAN Custom Fume Hood, for which you can Specify the Specification

Selectable Material of Custom-Made Fume Hood

	Material			
	PVC	P.P	ABS	
Exterior	PVC	P.P	ABS	
Interior	PVC	P.P	P.E	ABS
Work Top	PVC	P.P	P.E	ABS

- Made in Korea ■ Durable, Hazardous Chemical Gas Remove.
- PP(Polypropylene) Material for Excellent Resistance to Acid / Alkali / Chemicals / High Temp.

- * With Air-/Gas-/Water-Cock, Cup Sink, Drain, Explosion Proof Lamp, Receptacle, and Multi-purpose Cabinet.
- * **By Pass Air Flow-type** : After the Suction Forcing the Indoor Air to Discharge the Gas to the Outside
- * **Air Curtain Air Flow-type** : The Outdoor Air Sucked Form the Air Curtain to the Front Chamber, and the Exhaust Gas Back to Suction the Air
- * Discharging the Polluted Air and Toxic Gas Generated during the Experiment in a Laboratory to the Outside through the Duct Structure
- * Process Pipe & Duct Silicon Sealing to Completely Block the Gas Leakage to the Outside
- * The Mechanical Design is Manufactured with Superior Workability

Specification

Models & Air Flow-type	(A) By-Pass Air Flow-type			
	"HD-1200"	"HD-1500"	"HD-1800"	"HD-2400"
	(B) Air Curtain Air Flow-type			
	"HD-C1200"	"HD-C1500"	"HD-C1800"	"HD-C2400"
Duct Size	φ 200mm		φ 250mm	
Material*	(1) External · (3) Internal · (4) Work Top : PP (6) Column · (2) Sash Frame & Window : PVC			
Cabinet	(5) Built-in Multi-purpose PP Cabinet			
Lamp	LED Lamp(1ea × 20 W)			
Cock	1ea × Air-/Gas-/Water-Cock			
Receptacle	4ea 220V Concent or 4ea 110V Concent			
Dimension (w × d × h) (mm)	1200 × 800 × 2200	1500 × 800 × 2200	1800 × 800 × 2200	2400 × 800 × 2200
Power Supply *	1 Phase, AC 220V / 60Hz			

* Other Specifications(50Hz) are available upon Customer' s Request.

Ordering Information

(A) By-Pass Air Flow-type Ducted PP Fume Hood

- DH.WHD02112 Fume Hood, 230V, 1200 × 800 × h2200mm, "HD-1200"
- DH.WHD02115 , 1500 × 800 × h2200mm, "HD-1500"
- DH.WHD02118 , 1800 × 800 × h2200mm, "HD-1800"
- DH.WHD02124 , 2400 × 800 × h2200mm, "HD-2400"
- DH.WHD01112 Fume Hood, 120V, 1200 × 800 × h2200mm, "HD-1200"
- DH.WHD01115 , 1500 × 800 × h2200mm, "HD-1500"
- DH.WHD01118 , 1800 × 800 × h2200mm, "HD-1800"
- DH.WHD01124 , 2400 × 800 × h2200mm, "HD-2400"

Ea. Price, ₩

(B) Air Curtain Air Flow-type Ducted PP Fume Hood

- DH.WHD02212 Fume Hood, 230V, 1200 × 800 × h2200mm, "HD-C1200"
- DH.WHD02215 , 1500 × 800 × h2200mm, "HD-C1500"
- DH.WHD02218 , 1800 × 800 × h2200mm, "HD-C1800"
- DH.WHD02224 , 2400 × 800 × h2200mm, "HD-C2400"
- DH.WHD01212 Fume Hood, 120V, 1200 × 800 × h2200mm, "HD-C1200"
- DH.WHD01215 , 1500 × 800 × h2200mm, "HD-C1500"
- DH.WHD01218 , 1800 × 800 × h2200mm, "HD-C1800"
- DH.WHD01224 , 2400 × 800 × h2200mm, "HD-C2400"

Ea. Price, ₩

Optional Blower

- DH.WHD10010 Integrated Blower, "HDBL0010"
- DH.WHD10011 External Blower, "HDBL0011"

Ea. Price, ₩

- ※ Custom-Made Fume Hood : Wide Variety of Material for User Selection.
- ※ Note! Freight and Installation Charges Separately.

Articles	Cat. No	Description
----------	---------	-------------

DAIHAN® Ducted PP & PVC Wet Scrubber Fume Hood for Acid/Chemical Resistance, 1500 · 1800 · 2100 · 2400 mm
 (A) Bypass or (B) Air Curtain-Type, Circulation Pump, PP Pall Ring Filter, Demister, Air-/Gas-/Water-Cock, Cup Sink, and Drain
 내산/내약품용 덕트형 PP & PVC 스크러버 흡후드, PP 재질의 외부/내부/작업대, PVC 재질의 스크러버, 내화학성, 대기오염방지형

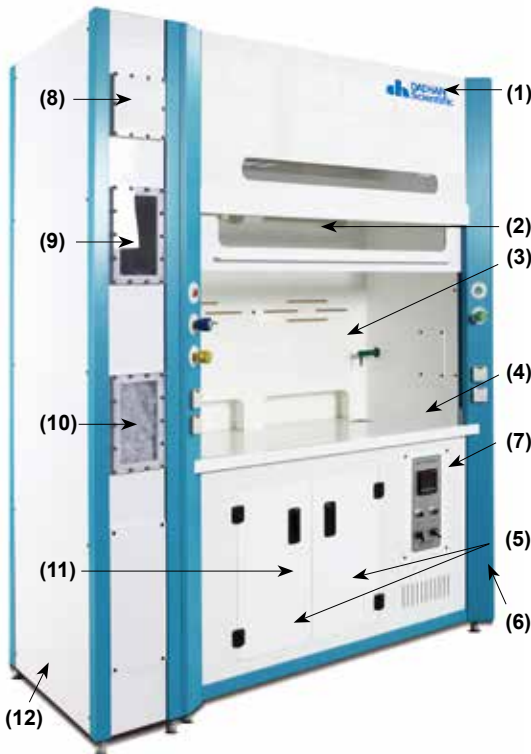

Ducted PP & PVC Wet Scrubber Hood "HD-1500S"

Diagram of Air Flow Depending on the Safety Window Opening

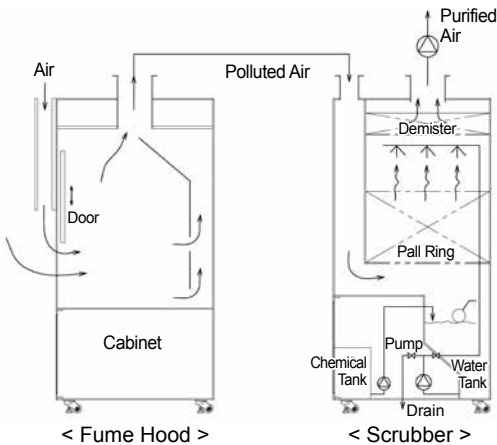

(B) Air Curtain Type
 Ducted PP & PVC Wet Scrubber Hood - Air Flow

Welcome! Custom-Made Fume Hood!!

We can Offer DAIHAN Custom Fume Hood, for which you can Specify the Specification

Selectable Material of Custom-Made Fume Hood

	Material			
Exterior	PVC	P.P	ABS	
Interior	PVC	P.P	P.E	ABS
Work Top	PVC	P.P	P.E	ABS

- Made in Korea ■ Durable, Hazardous Chemical Gas Remove.
- PP(Polypropylene) Material for Excellent Resistance to Acid / Alkali / Chemicals / High Temp.

- * with Air-/Gas-/Water-Cock, Cup Sink, Drain, Explosion Proof Lamp, Receptacle, Multi-purpose Cabinet.
- * Built-in Wet Scrubber : with Circulation Pump, Water Level Gauge, Water Storage Tank, PP Pall-ring Filter, Demister, Water Spray Nozzle, pH Indicator/Control Panel
- * By Pass Air Flow-type : After the Suction Forcing the Indoor Air to Discharge the Gas to the Outside
- * Air Curtain Air Flow-type : The Outdoor Air Sucked Form the Air Curtain to the Front Chamber, and the Exhaust Gas Back to Suction the Air
- * Moving the Experiment Polluted Air and Toxic Gases Generated in the Laboratory of the Scrubber through Duct Structure, and only the Purified Air Discharged to the Atmosphere after the Contaminants have been Removed
- * An Acidified Water drained to Neutralize * Required Equipment for Air Pollution Prevention
- * Through a pH Meter Display can Check the Current pH Level of the Water Storage Tank
- * Process Pipe & Duct Silicon Sealing to Completely Block the Gas Leakage to the Outside
- * The Mechanical Design is Manufactured with Superior Workability

Specification

Models & Air Flow-type	(A) By-Pass Air Flow-type			
	"HD-1500S"	"HD-1800S"	"HD-2100S"	"HD-2400S"
Duct Size	(B) Air Curtain Air Flow-type			
	"HD-C1500S"	"HD-C1800S"	"HD-C2100S"	"HD-C2400S"
Duct Size	φ 200mm		φ 250mm	
Material*	(1) External · (3) Internal · (4) Work Top · (7) pH Indicator/Control Panel · (8) Demister · (10) Pall Ring : PP, (2) Sash Frame & Window · (6) Column · (9) Window · (12) Wet Scrubber : PVC			
Cabinet	(5) Built-in Multi-purpose PP Cabinet			
Lamp	Explosion Proof Lamp(1ea × 20 W)			
Cock	1ea × Air-/Gas-/Water-Cock			
Receptacle	4ea 220V Concent or 4ea 110V Concent			
Circulation Pump	(11) Built in Magnetic Pump, 1 Phase, AC 220V, 1/3HP			
Water Level Gauge	Clear PVC			
Filter	(10) PP Pall Ring			
Demister	(8) PP Made (Mesh-type)			
Water Spray Nozzle	6mm PVC Nozzle			
Water Drain Line	PVC Pipe			
Dimension (w × d × h) (mm)	1500 × 800 × 2200	1800 × 800 × 2200	2100 × 800 × 2200	2400 × 800 × 2200
Power Supply *	1 Phase, AC 220V / 60Hz			

* Other Specifications(50Hz) are available upon Customer's Request.

Ordering Information

(A) By-Pass Air Flow-type, PP Wet Scrubber Fume Hood

	Ea. Price, ₩
DH.WHD02515 Fume Hood, 230V, 1500 × 800 × h2200mm, "HD-1500S"	
DH.WHD02518 , 1800 × 800 × h2200mm, "HD-1800S"	
DH.WHD02521 , 2100 × 800 × h2200mm, "HD-2100S"	
DH.WHD02524 , 2400 × 800 × h2200mm, "HD-2400S"	

(B) Air Curtain Air Flow-type, PP Wet Scrubber Fume Hood

	Ea. Price, ₩
DH.WHD02615 Fume Hood, 230V, 1500 × 800 × h2200mm, "HD-C1500S"	
DH.WHD02618 , 1800 × 800 × h2200mm, "HD-C1800S"	
DH.WHD02621 , 2100 × 800 × h2200mm, "HD-C2100S"	
DH.WHD02624 , 2400 × 800 × h2200mm, "HD-C2400S"	

Optional Blower

	Ea. Price, ₩
DH.WHD10011 External Blower, "HDBL0011"	

- * Custom-Made Fume Hood : Wide Variety of Material for User Selection.
- * Note! Freight and Installation Charges Separately.

Furnace

Furnace, Muffle, 1000 °C	P. 71
, Muffle, 1200 °C	P. 72
, Muffle, High Temperature, 1450 °C	P. 73
, Muffle, High Temperature, 1650 °C	P. 74
, Tube, 1000 °C	P. 75



1000 °C Muffle Furnace, "FX-14"



1200 °C Muffle Furnace, "FHX-63"



1650 °C High-Temp Muffle Furnace, "FSK-2"



1000 °C Tube Furnace, "FT-860"

DAIHAN® 1,000°C Programmable Digital Muffle Furnace "FX", Exposed Heating Elements-type
 With Digital PID Control, Short Heat-up Time, Ceramic Fiber, 4-Side Heating, with Ceramic Fiber Plate, 3~63 Lit
 디지털 전기로, 디지털 PID 컨트롤 시스템, 4면 가열 방식, 히터 노출형



Jog-Shuttle with Push Button

2-Year Warranty

14Lit "FX-14" 1000°C Model

- Made in Korea ■ CE Certified ■ PL (Product Liability) Insurance
- with Certificate & Traceability : Controlled by Serial Number, Certificate, Delivery-information, and Traceable Data Base System
- Patented Jog-Shuttle Control System and Digital LCD with Back-Light Function
- Digital PID Programmable Controller : 4 Patterns with 10 Segments
- * Designed for Ash-Determinations, Enameling, Fusions, Precipitate Drying
- * User's Self-Compensation Function for Temperature ($\pm 50^\circ\text{C}$) * Resolution : 1°C, 1min
- * Safety Switch for Door Opening * Ceramic Fiber exposed Heating Wire, 4-Side Heating

Specifications & Ordering information

Spec.	Model	"FX-03"	"FX-05"	"FX-12"	"FX-14"	"FX-27"	"FX-63"
		Max.Capa. 3 Lit	Max.Capa. 4.5 Lit	Max.Capa. 12 Lit	Max.Capa. 14 Lit	Max.Capa. 27 Lit	Max.Capa. 63 Lit
Temp. Range	300°C ~ 1000°C						
Capacity		3 Lit	4.5 Lit	12 Lit	14 Lit	27 Lit	63 Lit
Heater	Kanthal A1, Expose Wire Heating Elements, 4-Side Heating						
Thermocouple	K-type Thermocouple						
Heating Power		1.6 kW	1.7 kW	3.3 kW	4.0 kW	4.6 kW	9 kW
Required time to be reached 800°C		16 min		20 min		23 min	
Timer & Alarm	99hr 59min (Continuous run), Error status & Timer-end						
Display	Digital LCD with Back-Light Function						
Controller	Digital PID Controller with Jog-Dial Switch (Turn+Push)						
Program Function	4 Patterns with 10 Segments						
Safety Circuit	Over-Temp./-Current protection, Sensor Error Detection Safety Switch for Door Opening						
Material	Ceramic Fiber with Heating Wire-Internal, Powder Coated steel-External Ceramic Fiber-Insulation						
Dimension (w×d×h)	Internal (cm)	13×25×9	15×30×10	20×30×20	25×35×16	30×30×30	40×40×40
	External (cm)	41×48×53	44×53×55	50×55×66	55×59×62	60×59×76	100×75×95
Packing Size(w×d×h) (cm)		63×54×77	68×57×78	70×63×89	74×68×85	74×73×99	116×90×110
Gross Weight		47 kg	54 kg	59 kg	73 kg	83 kg	225 kg
Electrical Reqts.		1 Phase, AC 120V, 60Hz or AC 230V, 50/60Hz		1 Phase AC 120V, 60Hz or AC 230V, 50/60Hz or 3 Phase			
Cat. No.	230V	DH.WF21.03	DH.WF21.05	DH.WF21.12	DH.WF21.14	DH.WF21.27	DH.WF21.63
	120V	DH.WF20.03	DH.WF20.05	DH.WF20.12	DH.WF20.14	DH.WF20.27	-
	3Phase	-	-	DH.WF23.12	DH.WF23.14	DH.WF23.27	DH.WF23.63
Price, Each. ₩							

* Other Specifications are available upon Customer's Request.

※ 운임 약 ₩ 20,000 별도!



2-Year Warranty

63Lit "FX-63" 1000°C Model

Spare Ceramic Fiber Plate

- DH.WF211.03 (1) Ceramic Fiber Plate, 120×215mm, "FS1103" for 3Lit
- DH.WF211.05 , 140×265mm, "FS1105" for 4.5Lit
- DH.WF211.12 , 190×265mm, "FS1112" for 12Lit
- DH.WF211.14 , 240×310mm, "FS1114" for 14Lit
- DH.WF211.27 , 280×280mm, "FS1127" for 27Lit
- DH.WF211.63 , 400×400mm, "FS1163" for 63Lit

Ea. Price, ₩

Optional Glove

- K9.26592 (2) Glove, Heat Resistant, 800°C , 1Pair, L330 mm
- AS1.7896.01 (3) , 1000°C, 1Pair, L450 mm
- AS1.7896.02 , L350 mm

Ea. Price, ₩



Inner Chamber of Exposed Heating Elements-type



(1) Ceramic Fiber Plate (Included)



(2) Heat-resistant Glove (800°C)



(3) Heat-resistant Glove (1000°C)

DAIHAN® 1,200°C Programmable Digital Muffle Furnace “FHX”, Exposed Heating Elements-type
 With Digital PID Control, Short Heat-up Time, Ceramic Fiber, 4-Side Heating, with Ceramic Fiber Plate, 3~63 Lit
 디지털 전기로, 디지털 PID 컨트롤 시스템, 4면 가열 방식, 히터 노출형



Jog-Shuttle with Push Button

2-Year Warranty

14Lit “FHX-14” 1200°C Model



2-Year Warranty

63Lit “FHX-63” 1200°C Model

■ Made in Korea ■ CE Certified ■ PL (Product Liability) Insurance

■ with Certificate & Traceability : Controlled by Serial Number, Certificate, Delivery-information, and Traceable Data Base System

■ Patented Jog-Dial Control System and Digital LCD with Back-Light Function

■ Digital PID Programmable Controller : 4 Patterns with 10 Segments

- * Digital Jog-Dial Control System
- * Ceramic Fiber Exposed Heating Wire, 4-Side Heating
- * User's Self-Compensation Function for Temperature (± 50°C)
- * Included Ceramic Fiber Plate
- * Safety Switch for Door Opening
- * Resolution : 1°C, 1min

Specifications & Ordering information

Spec.	Model	“FHX-03”	“FHX-05”	“FHX-12”	“FHX-14”	“FHX-27”	“FHX-63”
		Max.Capa. 3 Lit	Max.Capa. 4.5 Lit	Max.Capa. 12 Lit	Max.Capa. 14 Lit	Max.Capa. 27 Lit	Max.Capa. 63 Lit
Temp. Range		300°C ~ 1200°C					
Capacity		3 Lit	4.5 Lit	12 Lit	14 Lit	27 Lit	63 Lit
Heater		Kanthal A1, Expose Wire Heating Elements, 4-Side Heating					
Thermocouple		K-type Thermocouple					
Heating Power		1.6 kW	1.7 kW	3.3 kW	4.0 kW	4.6 kW	9 kW
Required time to be reached 800°C		16 min		20 min		23 min	
Timer & Alarm		99hr 59min (Continuous run), Error status & Timer-end					
Display		Digital LCD with Back-Light Function					
Controller		Digital PID Controller with Jog-Dial Switch (Turn+Push)					
Program Function		4 Patterns with 10 Segments					
Safety Circuit		Over-Temp./-Current protection, Sensor Error Detection Safety Switch for Door Opening					
Material		Ceramic Fiber with Heating Wire-Internal, Powder Coated steel-External Ceramic Fiber-Insulation					
Dimension (w×d×h)	Internal (cm)	13×25×9	15×30×10	20×30×20	25×35×16	30×30×30	40×40×40
	External (cm)	41×48×53	44×53×55	50×55×66	55×59×62	60×59×76	100×75×95
Packing Size(w×d×h) (cm)		63×54×77	68×57×78	70×63×89	74×68×85	74×73×99	116×90×110
Gross Weight		47 kg	54 kg	59 kg	73 kg	83 kg	225 kg
Electrical Reqts.		1 Phase, AC 120V, 60Hz or AC 230V, 50/60Hz		1 Phase AC 120V, 60Hz or AC 230V, 50/60Hz or 3 Phase			
Cat. No.	230V	DH.WFH22.03	DH.WFH22.05	DH.WFH22.12	DH.WFH22.14	DH.WFH22.27	DH.WFH22.63
	120V	DH.WFH20.03	DH.WFH20.05	DH.WFH20.12	DH.WFH20.14	DH.WFH20.27	-
	3Phase	-	-	DH.WFH23.12	DH.WFH23.14	DH.WFH23.27	DH.WFH23.63
Price, Each. ₩							

* Other Specifications are available upon Customer's Request.

※ 운임 약 ₩ 20,000 별도!

Spare Ceramic Fiber Plate

- DH.WF211.03 (1) Ceramic Fiber Plate, 120×215mm, “FS1103” for 3Lit
- DH.WF211.05 , 140×265mm, “FS1105” for 4.5Lit
- DH.WF211.12 , 190×265mm, “FS1112” for 12Lit
- DH.WF211.14 , 240×310mm, “FS1114” for 14Lit
- DH.WF211.27 , 280×280mm, “FS1127” for 27Lit
- DH.WF211.63 , 400×400mm, “FS1163” for 63Lit

Ea. Price, ₩

Optional Glove

- K9.26592 (2) Glove, Heat Resistant, 800°C , 1Pair, L330 mm
- AS1.7896.01 (3) , 1000°C, 1Pair, L450 mm
- AS1.7896.02 , L350 mm

Ea. Price, ₩



Inner Chamber of Exposed Heating Elements-type



(1) Ceramic Fiber Plate (Included)



(2) Heat-resistant Glove (800°C)



(3) Heat-resistant Glove (1000°C)

Articles	Cat. No	Description
----------	---------	-------------

“WiseTherm® FSC” 1,450°C Programmable High-Temp Muffle Furnace, Exposed Heating Elements-type
 With SIC Heater, Digital PID Control, Short Heat-up Time, 2-Side Heating, without Ceramic Fiber Plate, 1.9~22 Lit
 고온 디지털 전기로, 디지털 PID 컨트롤 시스템, 2면 가열 방식



2-Year Warranty

1.9Lit “FSC-2” 1450°C Model

- Made in Korea
- PL(Product Liability) Insurance
- with Certificate & Traceability : Controlled by Serial Number, Certificate, Delivery-information, and Traceable Data Base System
- Digital PID Programmable Controller : 2 Patterns with 10 Segments
- Digital LCD Display
- High Quality Insulation : Ceramic Fiber Board
- SIC(Silicon Carbide) Heater

- * Safety Door Lock System
- * Excluding Ceramic Fiber Plate
- * Ceramic Fiber Exposed Heating Wire, 2-Side Heating
- * Safety Switch for Door Opening

Specifications & Ordering information

Spec.	Model	WiseTherm® FSC-2	WiseTherm® FSC-5	WiseTherm® FSC-11	WiseTherm® FSC-22
		Max. Capa. 1.9Lit	Max. Capa. 4.5Lit	Max. Capa. 11Lit	Max. Capa. 22Lit
Temp. Range		500°C ~ 1450°C			
Capacity		1.9 Lit	4.5 Lit	11 Lit	22 Lit
Heater		SIC Heater, 2-Side Heating			
Thermocouple		R-type Thermocouple			
Heating Power		2 kW	3.3 kW	7.7 kW	9.6 kW
Required time to be reached 800°C		30 min			
Timer & Alarm		99hr 59min or Continuous run			
Display		Digital LCD Display			
Controller		Digital PID Controller, UP35A, SCR Power Controller with Push Button			
Program Function		2 Patterns with 10 Segments			
Safety Circuit		Over-Temp./-Current protection, Sensor Error Detection, Safety Switch for Door Opening	Over-Temp./-Current protection, Sensor Error Detection		
Material		Ceramic Fiber board with SIC Heater-Internal, Powder Coated steel-External, Ceramic Fiber-Insulation			
Dimension (w×d×h)	Internal (mm)	120×130×120	150×200×150	200×270×200	250×350×250
	External (mm)	440×482×700	820×555×655	870×625×715	920×705×785
Packing Size(w×d×h) (cm)		680×540×940	1350×600×890	1400×770×950	1450×900×1100
Gross Weight		57 kg	70 kg	102 kg	132 kg
Electrical Reqts.		1 Phase, AC 120V, 60Hz or AC 230V, 50/60Hz, without Cord and Plug			
Cat. No.	230V	DH.FSC02002	DH.FSC02005	DH.FSC02011	DH.FSC02022
	120V	DH.FSC01002	DH.FSC01005	DH.FSC01011	DH.FSC01022
Price, Each. ₩					



2-Year Warranty

4.5/11/22-Lit “FSC-5”, “FSC-11” & “FSC-22” 1450°C Model

* Other Specifications are available upon Customer's Request.

※ 운임 약 ₩ 20,000 별도!



Inner Chamber of Exposed Heating Elements-type

Optional Ceramic Fiber Plate

- DH.FSC2002 (1) Ceramic Fiber Plate, w110×d120mm, for 1.9Lit
- DH.FSC2005 , w140×d180mm, for 4.5Lit
- DH.FSC2011 , w190×d250mm, for 11Lit
- DH.FSC2022 , w240×d330mm, for 22Lit

Ea. Price, ₩

Optional Glove

- K9.26592 (2) Glove, Heat Resistant, 800°C , 1Pair, L330 mm
- AS1.7896.01 (3) , 1000°C, 1Pair, L450 mm
- AS1.7896.02 , L350 mm

Ea. Price, ₩



(1) Ceramic Fiber Plate (Included)



(2) Heat-resistant Glove (800°C)



(3) Heat-resistant Glove (1000°C)

“WiseTherm® FSK” 1,650°C Programmable High-Temp Muffle Furnace, Exposed Heating Elements-type
 With MoSi₂ Heater, Digital PID Control, Short Heat-up Time, 2-Side Heating, without Ceramic Fiber Plate, 1.9~ 11 Lit
 고온 디지털 전기로, 디지털 PID 컨트롤 시스템, 2면 가열 방식



2-Year Warranty

1.9Lit “FSK-2” 1650°C Model



2-Year Warranty

4.5&11Lit “FSK-5” & “FSK-11” 1650°C Model



Inner Chamber of Exposed Heating Elements-type

- Made in Korea ■ PL(Product Liability) Insurance
- with Certificate & Traceability : Controlled by Serial Number, Certificate, Delivery-information, and Traceable Data Base System
- Digital PID Programmable Controller : 2 Patterns with 10 Segments
- Digital LCD Display ■ High Quality Insulation : Ceramic Fiber Board
- * Safety Door Lock System * Excluding Ceramic Fiber Plate
- * Ceramic Fiber Exposed Heating Wire, 2-Side Heating * Safety Switch for Door Opening

Specifications & Ordering information

Spec.	Model	WiseTherm® FSK-2	WiseTherm® FSK-5	WiseTherm® FSK-11
		Max. Capa. 1.9 Lit	Max. Capa. 4.5 Lit	Max. Capa. 11 Lit
Temp. Range		600°C ~ 1650°C		
Capacity		1.9 Lit	4.5 Lit	11 Lit
Heater		MoSi ₂ Heater, 2-Side Heating		
Thermocouple		B-type Thermocouple		
Heating Power		1.3 kW	2.9 kW	6.6 kW
Required time to be reached 800°C		40 min		
Timer & Alarm		99hr 59min or Continuous run		
Display		Digital LCD Display		
Controller		Digital PID Controller, UP35A, SCR Power Controller with Push Button		
Program Function		2 Patterns with 10 Segments		
Safety Circuit		Over-Temp./-Current protection, Sensor Error Detection, Safety Switch for Door Opening	Over-Temp./-Current protection, Sensor Error Detection	
Material		Ceramic Fiber board with MOSi ₂ Heater-Internal, Powder Coated steel-External, Ceramic Fiber-Insulation		
Dimension (w×d×h)	Internal (mm)	120×130×120	150×200×150	200×270×200
	External (mm)	440×482×700	900×600×695	980×670×765
Packing Size(w×d×h) (cm)		680×540×940	1430×640×930	1510×810×1000
Gross Weight		72 kg	150 kg	186 kg
Electrical Reqts.		1 Phase, AC 120V, 60Hz or AC 230V, 50/60Hz, without Cord and Plug		
Cat. No.	230V	DH.FSK02002	DH.FSK02005	DH.FSK02011
	120V	DH.FSK01002	DH.FSK01005	DH.FSK01011
Price, Each. ₩				

* Other Specifications are available upon Customer's Request.

※ 운임 약 ₩ 20,000 별도!

Optional Ceramic Fiber Plate

- DH.FSK2002 (1) Ceramic Fiber Plate, w110×d120mm, for 1.9Lit
- DH.FSK2005 , w140×d180mm, for 4.5Lit
- DH.FSK2011 , w190×d250mm, for 11Lit

Ea. Price, ₩

Optional Glove

- K9.26592 (2) Glove, Heat Resistant, 800°C , 1Pair, L330 mm
- AS1.7896.01 (3) , 1000°C, 1Pair, L450 mm
- AS1.7896.02 , L350 mm

Ea. Price, ₩

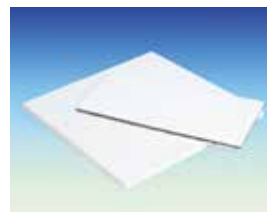

(1) Ceramic Fiber Plate (Included)



(2) Heat-resistant Glove (800°C)



(3) Heat-resistant Glove (1000°C)

Articles	Cat. No	Description
----------	---------	-------------

DAIHAN® Programmable Tube Furnaces “FT-series”, Embedded Heating Elements-type, 1000°C
 With Digital PID Programmable Control, 1- or 3-Heating Zone, $\phi 3\sim\phi 14$ cm Tubes, 1,000°C 프로그램식 튜브 전기로



(1) Programmable Tube Furnace, 1 Heating Zone “FT-860”



Side Figure of “FT-860”



(a) Heat-resistant Glove (800°C)



(b) Heat-resistant Glove (1000°C)

- Made in Korea ■ PL(Product Liability) Insurance
- with Certificate & Traceability : Controlled by Serial Number, Certificate, Delivery-information, and Traceable Data Base System

- * Digital PID Programmable Controller : 3 Patterns with 16 Segments
- * Designed for Ash-Determinations, Horizontal Application, Protective Gas Atmosphere
- * Available Order Various Size Tubes, Without Working Tube
- * Programmable Timer : 99hr 59min
- * Resolution : 1°C, 1min

Specifications & Ordering information

Model	“FT-series” 1- or 3-Heating Zone						
Temp. Range & Heater	300°C ~ 1000°C, Kantal A1, Embedded Wire Heating Elements						
Thermocouple & Display	K-type Thermocouple, LED						
Safety Circuit	Over-Temp./-Current protection, Sensor Error Detection						
Material	Ceramic Fiber with Heating Wire-Internal, Powder Coated steel-External						
(1) 1Heatong Zone Model	“FT-830”	“FT-860”	“FT-1230”	“FT-1260”	“FT-1630”	“FT-1660”	
Heating Zone	1× Heating Zone						
	$\phi 8\times L30$	$\phi 8\times L60$	$\phi 12\times L30$	$\phi 12\times L60$	$\phi 16\times L30$	$\phi 16\times L60$	
Available Tube Size(cm)	$\phi 3\sim\phi 6$ cm		$\phi 7\sim\phi 10$ cm		$\phi 10\sim\phi 14$ cm		
Heating Power	1.8 kW	3.2 kW	2.2 kW	4.5 kW	3.2 kW	6.2 kW	
Heat-up Time(to 800°C)	17 min	20 min	18 min	22 min	20 min	25 min	
Dimension (w×d×h cm)	40×28×44	70×28×44	40×34×50	70×34×50	40×40×56	70×40×56	
Controller	1× Programmable PID Controller : 3 Patterns 16 Segments						
Cat. No.	230V	DH.WFT12.0830	DH.WFT12.0860	DH.WFT12.1230	DH.WFT12.1260	DH.WFT12.1630	DH.WFT12.1660
	120V	DH.WFT11.0830	DH.WFT11.0860	DH.WFT11.1230	DH.WFT11.1260	DH.WFT11.1630	DH.WFT11.1660
Price, Each. ₩							
(2) 3Heatong Zone Model	“FT-3860”		“FT-31260”		“FT-31660”		
Heating Zone	3× Heating Zone						
	$\phi 8\times (3\times L20\text{cm})$		$\phi 12\times (3\times L20\text{cm})$		$\phi 16\times (3\times L20\text{cm})$		
Available Tube Size(cm)	$\phi 3\sim\phi 6$ cm		$\phi 7\sim\phi 10$ cm		$\phi 10\sim\phi 14$ cm		
Heating Power	3.3 kW		4.8 kW		6.6 kW		
Heat-up Time(to 800°C)	20 min		22 min		25 min		
Dimension (w×d×h cm)	70×28×h44 cm		70×34×h50 cm		70×40×h56 cm		
Controller	Independent 3× Programmable PID Controller : 3 Patterns 16 Segments						
Cat. No.	230V	DH.WFT12.860.3		DH.WFT12.1260.3		DH.WFT12.1660.3	
	120V	DH.WFT11.860.3		DH.WFT11.1260.3		DH.WFT11.1660.3	
Price, Each. ₩							

* Other Specifications are available upon Customer's Request. ※ 운임 약 ₩ 20,000 별도!
 * Tubes Size & Other Specifications are available upon Customer's Request

Optional Glove

- K9.26592 (a) Glove, Heat Resistant, 800°C , 1Pair, L330 mm
- AS1.7896.01 (b) , 1000°C, 1Pair, L450 mm
- AS1.7896.02 , L350 mm

Ea. Price, ₩

DAIHAN® Laboratory Assembly Furniture, High Quality Steel-Frame/-Side Panel and Phenol Work Top, SUS Bolted Joint With Transfer Cabinet, Utility Box, 실험실용 조립식 실험대, 고품질 스틸 프레임, 내열성/내충격성/내화학성 페놀 상판, 볼트식 결합

- **Made in Korea** ■ **Easy to Assemble with Stainless-steel(SUS 304) Bolts and Stable**
- **Phenol Work Top : Good for Heat-/Shock-Resistant, Excellent Chemical-Resistant(Acetic Acid, Alcohol, Hydrochloric Acid, Sulfuric Acid, Organic Chemicals, Base, Biological Stains, Salt, Solvent, etc.)**
- **High Quality Steel-Frame(60×40 & 50×30mm), Side-/Back-Steel Panel(t1.6mm)**
- **The Work Top are made of Melamine, Granite, Phenol(Color Choices Available : Black or Gray)**
- **You can Choose the Materials of the Work Top according to Usage and Change the Height of Table.**

Features of Work Top Materials

- * Phenol(Phenolic Laminate) : Excellent for Heat-/ Chemical-/ Shock-Resistance, Strong Plate Consist of Melamine-resin and Phenolic-resin, Surface Strengthening through Chemical and Chemical Treatment, Good for All Purpose Laboratory.
- * Melamine : Good for Chemical and Heat-Resistance. The Surface is Resistant against Scratches and Abrasion. Suitable for Analytical Laboratory.
- * Granite : Excellent for Heat and Shock-Resistance. Suitable for Special Laboratory like Instrumental Analysis Laboratory.

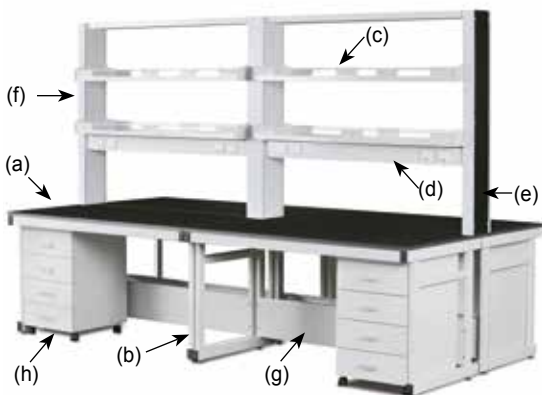

Structures and Features of Assembly Furniture

- * (a) Phenol Work Top : Good for Heat-/Shock-Resistant Phenolic Laminate(t20mm), Excellent Chemical-Resistant (Acetic Acid, Alcohol, Hydrochloric Acid, Sulfuric Acid, Organic Chemicals, Base, Biological Stains, Salt, Solvent, etc.), Color Choices Available : Black or Gray
- * (b) Frame : The Most Stable Steel Under Construction, Suitable for Long-term Loading of Heavy Analysis Equipment, High Quality Steel, 60×40mm & 50×30mm
- * (c) Shelves : Shelf Fall Prevention Design, Movable Up and Down, Aluminum Frame, PVC Shelf Plate(t8mm), Epoxy Powder Coating Steel Shelf Supporter(t1.6mm)
- * (d) Utility Box : Electrical safety design, Attachment Emergency Breaker and Switch Box for Each Line, Steel Plate(t1.6mm), Cover type Power Outlet(220V)
- * (e) Reagent Structure : Al Frame & Steel Plate(1.6mm), Columns bend(Edge Rounding) to Secure LAN Line, Electricity, Gas, Water etc., Maintenance and Safety Enhancement
- * (f) Reagent Front / Rear Frame : Anodizing and Electro-deposition Treatment on Environmentally Friendly Aluminum Surface to Enhance Strength, Abrasion-Resistance, Corrosion-Resistance and Electrical insulation
- * (g) Modular System Back Panel
 - Easily Removable and Easy to Follow and Check (Scalability)
 - Eco-friendly Epoxy Powder Coating to Prevent Scratches and Corrosion
 - Using Steel Plate t1.6mm
- * (h) Transfer Cabinet : Particle Board Plate(t15/18mm) / Al-handle / Brake Caster / 450×500×h700mm, Basic 4-stage(2-/3-stage possible)
- * Attach Inner Support : Use of Steel Pipe for Loaded Area and Flexural Reinforcement
- * Sink Tables : We can Offer DAIHAN Custom Sink Table, for which you can Specify the Specification

※ Sequence of Assemble the Table

Package : Total 4 Box including Transfer Cabinet (Work Top / Frame / Panel / Transfer Cabinet)

1. Connect the Work Top Frame and Right Leg Frame with SUS Bolts using a Screwdriver
2. Connect the Work Top Frame and Left Leg Frame with SUS Bolts using a Screwdriver
3. Connect the Bottom Panel and the Left Leg Frame with SUS Bolts using a Screwdriver
4. Connect the Bottom Panel and the Right Leg Frame with SUS Bolts using a Screwdriver
5. Place the Work Top on the Completed Lower Frame
6. Finished Assembly
7. Place the Complete Assembly Transfer Cabinet in the desired location

WFE401 Series, w1800mm

Articles	Cat. No	Description
----------	---------	-------------

DAIHAN® Laboratory Assembly Center Table, High Quality Steel-Frame/-Side Panel and Phenol Work Top, SUS Bolted Joint With Transfer Cabinet, Utility Box, 실험실용 조립식 중앙 실험대, 고품질 스틸 프레임, 내열성/내충격성/내화학성 페놀 상판, 볼트식 결합

- **Made in Korea** ■ **Easy to Assemble with Stainless-steel(SUS 304) Bolts and Stable**
- **Phenol Work Top : Good for Heat-/Shock-Resistant, Excellent Chemical-Resistant(Acetic Acid, Alcohol, Hydrochloric Acid, Sulfuric Acid, Organic Chemicals, Base, Biological Stains, Salt, Solvent, etc.)**
- **High Quality Steel-Frame(60×40 & 50×30mm), Side-/Back-Steel Panel(t1.6mm)**
- * The Most Stable Steel Under Construction, Suitable for Long-term Loading of Heavy Analysis Equipment (60×40 & 50×30mm)
- * Chemical-resistance Phenolic Laminate Work Top, t20mm (Color Choices Available : Black or Gray)
- * Could be Change the Work Top, Height of Table on User Applications. Please Call to specify the Work Top.

(1) Assembly Basic Center Table, with Transfer Cabinet, Steel-Frame/-Side Panel & Phenol Work Top

- * Work Top : Phenol Plate, t20mm * Back Panel : Steel Plate, t1.6mm * Frame : Steel, 60×40 & 50×30mm



WFE301 Series, w2400mm

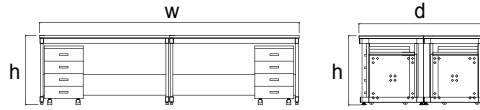

- DH.WFE3011 Center Table, 1500×1500×h800mm, with Cabinet(2ea)
- DH.WFE3012 , 1800×1500×h800mm, with Cabinet(2ea)
- DH.WFE3013 , 2100×1500×h800mm, with Cabinet(4ea)
- DH.WFE3014 , 2400×1500×h800mm, with Cabinet(4ea)
- DH.WFE3015 , 3000×1500×h800mm, with Cabinet(4ea)
- DH.WFE3016 , 3600×1500×h800mm, with Cabinet(4ea)

- ※ Assembly Details : See Page 76
- ※ **Note! Freight and Installation Charges Separately.**

Ea.	Price, ₩

(2) Assembly Shelf-type Center Table, with Transfer Cabinet/Shelves, Steel-Frame/-Side Panel & Phenol Work Top

- * Work Top : Phenol Plate, t20mm * Back Panel : Steel Plate, t1.6mm * Frame : Steel, 60×40 & 50×30mm * Size : d1500×h800/1900mm



WFE302 Series, w2400mm

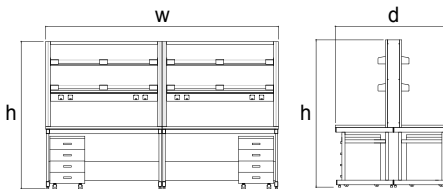

- DH.WFE3021 Center Table, w1500×h800/1900mm, with Cabinet(2ea) / Shelves
- DH.WFE3022 , w1800×h800/1900mm, with Cabinet(2ea) / Shelves
- DH.WFE3023 , w2100×h800/1900mm, with Cabinet(4ea) / Shelves
- DH.WFE3024 , w2400×h800/1900mm, with Cabinet(4ea) / Shelves
- DH.WFE3025 , w3000×h800/1900mm, with Cabinet(4ea) / Shelves
- DH.WFE3026 , w3600×h800/1900mm, with Cabinet(4ea) / Shelves

- ※ Assembly Details : See Page 76
- ※ **Note! Freight and Installation Charges Separately.**

Ea.	Price, ₩

(3) Assembly Comprehensive Center Table, with Cabinet/Sink Table/Shelves, Steel-Frame/-Side Panel & Phenol Work Top

- * Work Top : Phenol Plate, t20mm * Back Panel : Steel Plate, t1.6mm * Frame : Steel, 60×40 & 50×30mm * Size : d1500×h800/1900mm
- * Sink Top : Phenol Plate, t20mm * Water Guard : 3-sided Tempered Glass * with Cabinet(4ea) / Shelves / Sink Table * Sink Bowl : PP(Polypropylene)



WFE303 Series, w3150mm

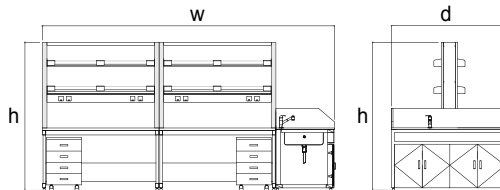

- DH.WFE3031 Center Table, w2250×h1900mm, with Shelves / Sink Table
- DH.WFE3032 , w2550×h1900mm, with Shelves / Sink Table
- DH.WFE3033 , w2850×h1900mm, with Shelves / Sink Table
- DH.WFE3034 , w3150×h1900mm, with Shelves / Sink Table
- DH.WFE3035 , w3750×h1900mm, with Shelves / Sink Table
- DH.WFE3036 , w4350×h1900mm, with Shelves / Sink Table

- ※ Assembly Details : See Page 76
- ※ **Note! Freight and Installation Charges Separately.**

Ea.	Price, ₩

DAIHAN® Laboratory Assembly Side Table, High Quality Steel-Frame/-Side Panel and Phenol Work Top, SUS Bolted Joint With Transfer Cabinet, Utility Box, 실험실용 조립식 벽면 실험대, 고품질 스틸 프레임, 내열성/내충격성/내화학성 페놀 상판, 볼트식 결합

- **Made in Korea** ■ **Easy to Assemble with Stainless-steel(SUS 304) Bolts and Stable**
- **Phenol Work Top : Good for Heat-/Shock-Resistant, Excellent Chemical-Resistant(Acetic Acid, Alcohol, Hydrochloric Acid, Sulfuric Acid, Organic Chemicals, Base, Biological Stains, Salt, Solvent, etc.)** ■ **High Quality Steel-Frame, Side-/Back-Steel Panel(t1.6mm)**

* The Most Stable Steel Under Construction, Suitable for Long-term Loading of Heavy Analysis Equipment (60×40mm & 50×30mm)
 * Chemical-Resistance Phenolic Laminate Work Top, t20mm (Black or Gray) * Could be Change the Work Top, Height of Table on User Applications.

(1) Assembly Basic Side Table, with Transfer Cabinet, Steel-Frame/-Side Panel & Phenol Work Top

* Work Top : Phenol Plate, t20mm * Back Panel : Steel Plate, t1.6mm * Frame : Steel, 60×40 & 50×30mm



WFE401 Series, w1800mm

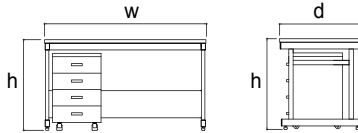

- DH.WFE4011 Side Table, 1200×750×h800mm, with Cabinet(1ea)
- DH.WFE4012 , 1500×750×h800mm, with Cabinet(1ea)
- DH.WFE4013 , 1800×750×h800mm, with Cabinet(1ea)
- DH.WFE4014 , 2100×750×h800mm, with Cabinet(2ea)
- DH.WFE4015 , 2400×750×h800mm, with Cabinet(2ea)

※ Assembly Details : See Page 76

※ **Note! Freight and Installation Charges Separately.**

Ea.	Price, ₩

(2) Assembly Shelf-type Side Table, with Transfer Cabinet/Shelves, Steel-Frame/-Side Panel & Phenol Work Top

* Work Top : Phenol Plate, t20mm * Back Panel : Steel Plate, t1.6mm * Shelves : PVC Shelf Plate(t8mm) & Steel / Aluminum Shelf Supporter(t1.6mm)



WFE402 Series, w1800mm

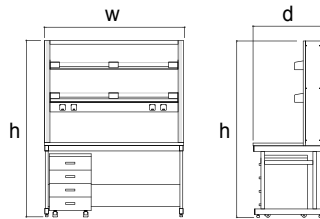

- DH.WFE4021 Side Table, 1200×750×h800/1900mm, with Cabinet / Shelves
- DH.WFE4022 , 1500×750×h800/1900mm, with Cabinet / Shelves
- DH.WFE4023 , 1800×750×h800/1900mm, with Cabinet / Shelves
- DH.WFE4024 , 2100×750×h800/1900mm, with Cabinet / Shelves
- DH.WFE4025 , 2400×750×h800/1900mm, with Cabinet / Shelves

※ Assembly Details : See Page 76

※ **Note! Freight and Installation Charges Separately.**

Ea.	Price, ₩

DAIHAN® Laboratory Sink Table, High Quality Steel-Frame/-Side Panel, Phenol Sink Top, PP Sink Bowl, Glass Water Guard With ① Cold & Hot Water Mixed Faucet, 실험실용 싱크대, 3면 강화유리, 재질 변경 가능

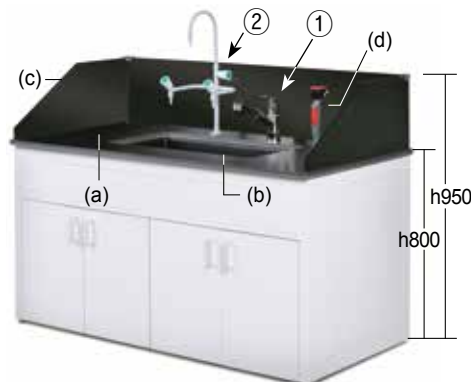

- * ② 3-mouth Chemical Faucet Available(Optional)
- * Sink Top : Chemical-resistance Phenolic Laminate t20mm * Sink Bowl : PP(Selectable Material)
- * Water Guard : Composed of 3-sided Tempered Glass t8mm(Selectable Material)

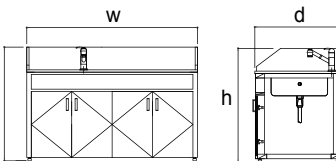

- DH.WFE4031 Sink Table, Laboratory, 900×750×h800 / 950mm
- DH.WFE4032 , 1200×750×h800 / 950mm
- DH.WFE4033 , 1500×750×h800 / 950mm
- DH.WFE4034 , 1800×750×h800 / 950mm

Selectable Material of Custom-Made Sink Table

	Material			
(a) Sink Top	Phenol	P.P	PVC	SUS
(b) Sink Bowl	-	P.P	PVC	SUS
(c) Water Guard	Glass	P.C	PVC	PVC

Ea.	Price, ₩

Welcome! Custom-Made Sink Table!!

We can Offer DAIHAN Custom Sink Table, for which you can Specify the Specification

Optional Eye-washer

DH.WFE4040 (d) Option ; Eye-washer, Single Nozzle, Table Mounted, L1.4m

※ **Note! Freight and Installation Charges Separately.**

Ea.	Price, ₩

DAIHAN® Ducted Safety Cabinet, with Clear PVC-/Safety Glass-Door Window, Built-in PP/Al-buttruss
With Internal & External PP/Steel Plate, Duct & Pipe Silicon Sealing, Gas Leak Completely Blocked, 덕트형 약품기구 보관장, 환기형

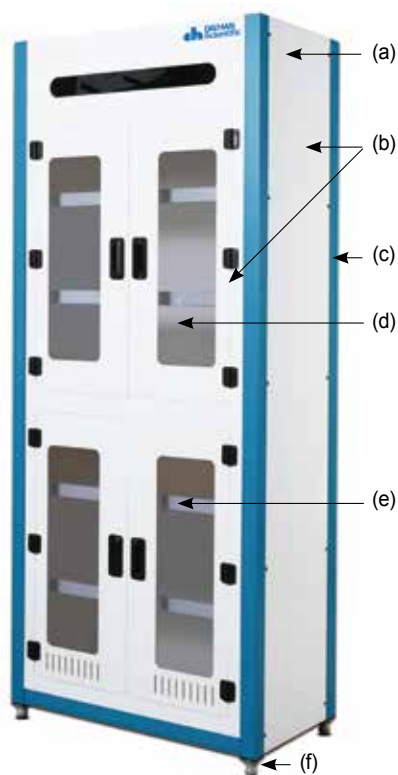

(1) PP Safety Cabinet, "FGC-2001"

- **Made in Korea** ■ **Durable, Hazardous Chemical Gas Remove.**
- **Internal / External PP Sheet / Steel Plate Good Resistance of Chemicals & Acid.**
- **Clear PVC-/Tempered Safety Glass-Window**
(Custom-Made Safety Cabinet : Wide Variety of Material for User Selection)

- * Discharging Toxic Gas Generated During Storage Various Reagents to the Outside through the Duct Structure
- * Effective in Maintaining a Comfortable indoor to Prevent the Laboratory Room Air being Polluted.
- * It may Create a Space to Treat the Harmful Substances in the Human Body Safely and Comfortably
- * Process Pipe & Duct Silicon Sealing to Completely Block the Gas Leakage to the Outside
- * Optional Blower User Selection : External-model(Stainless steel-/ Steel-/ PVC-/ PP-Blower) & Internal-model(Steel-/ PVC-/ PP-Blower)
- * Optional 24-hour Timer : Automatically Adjustable Exhaust attached to a Safety Cabinet

(1) Ducted PP Safety Cabinet, Clear PVC Door Window

- **Internal / External PP Material Resistance of Chemicals and Acids**
- **Built-in PP-buttruss** ■ **1-Room, 4-Door, 5-Shelf**

- * Safe Storage of Chemicals and Acids
- * Door Window : Use the Clear PVC Transparency and Protect the Experimenter Against the Risk of Explosion.
- * Basic Materials of Construction : Internal(PP), External(PP), 5-stage a Fixed Shelf(PP)

Specifications & Ordering information

Spec.	Model	"FGC-2001" Length. 900mm	"FGC-2003" Length. 1200mm	"FGC-2005" Length. 1500mm
(a) Duct size		φ 100mm / φ 150mm		
(b) Body & Door Material		PP		
(c) Column Material		PVC		
(d) Door Window Material		Clear PVC		
(e) Shelf Material		PP (5 Fixed-type)		
(f) Foot Material		PVC(Height Adjustable up to 30mm)		
Dimension(w × d × h)		900 × 500 × h2100mm	1200 × 500 × h2100mm	1500 × 500 × h2100mm
Power Supply		220V / 60Hz		
Cat. No.		DH.FGC2001	DH.FGC2003	DH.FGC2005
Price, Ea. ₩				

* Other Specifications are available upon Customer's Request.

※ **Note! Freight and Installation Charges Separately.**

(2) Ducted Steel Safety Cabinet, Tempered Safety Glass Door Window

- **Internal/External Steel plate with Powder finished for Resistance of Chemicals**
- **Built-in Particle Board-plate & Al-buttruss** ■ **1-Room, 2-Door, 5-Shelf**

- * Safe Storage of Chemicals
- * Use Tempered Safety Glass Protects the Experimenter Against the Risk of Explosion.
- * Basic Materials of Construction : Internal(Steel), External(Steel), 5-stage a Fixed Shelf(PB & Al)

Specifications & Ordering information

Spec.	Model	"FGC-900" Length. 900mm	"FGC-1200" Length. 1200mm	"FGC-1500" Length. 1500mm
(a) Duct size		φ 100mm / φ 150mm		
(b) Body & Door Material		Steel(with Powder Finished)		
(c) Door Window Material		Tempered Safety Glass		
(d) Shelf Material		PB(Particle Board) Plate + Aluminum Buttruss (5 Fixed-type)		
(e) Foot Material		Stainless-steel(Height Adjustable up to 30mm)		
Dimension(w × d × h)		900 × 500 × h2100mm	1200 × 500 × h2100mm	1500 × 500 × h2100mm
Power Supply		220V / 60Hz		
Cat. No.		DH.FGC900	DH.FGC1200	DH.FGC1500
Price, Ea. ₩				

* Other Specifications are available upon Customer's Request.

※ **Note! Freight and Installation Charges Separately.**

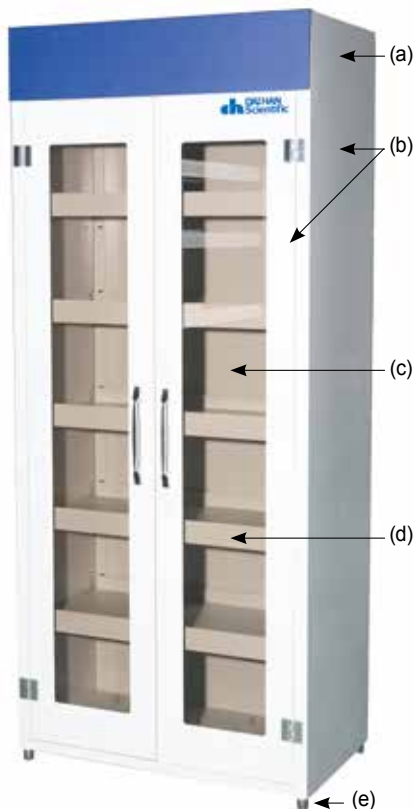

(2) Steel Safety Cabinet, "FGC-900"

DAIHAN® Premium Compact-size Heating Block/Dry Bath Incubator “MaXtable™ H20”

With Large LCD display, Fuzzy Control, Molded Heater, Modular Anodized Aluminum Blocks, up to 150°C, ±0.1°C 히팅 블록, 디지털 퍼지 컨트롤 시스템, 터치버튼식 조절기, 일체형 주물 히터, 블록 교체 가능, 블록 추출용 공구 포함



Heating Block/Dry Bath “MaXtable™ H20-set”

- Made in Korea ■ CE Certified ■ PL(Product Liability) Insurance
- with Certificate & Traceability : Controlled by Serial Number, Certificate, Delivery-information, and Traceable Data Base System
- Designed for Multi-functional Dry Block Heater ■ Ergonomic Design
- Patented Jog-Dial and Main Touch Button - Best Durability, Best Mobility, Best Convenient to Operate. with Large Back-Light LCD
- With a Screw-type Block Removal Tool ; Convenient Handling
- * High-performance Molded Heater ensures Best Temperature Accuracy.
- * Internal Bath Material(PPS) ensures Best Heat Insulation * Rapid heat up time.
- * Ideal for Enzyme Reactions, Inactivation of Sera, Incubation and Other Laboratory Procedures
- * Precise Temperature Control : ±0.1°C at 37°C, ±0.2°C at 90°C, ±0.4°C at 135°C
- * User Self-Compensation Function to offset between Actual and Displayed Temperature. (±10.0°C)
- * Digital Timer Included : up to 99hr 59min (Operation Time + Delay Time)
- * Storage Function of Temperature and Timer setting values
- * Convenient integral timer for time-sensitive incubations
- * Alarm Function : Error Status and Timer-end * Easy to Read, Wide LCD Screen
- * Locking Mode Supported for Experimental Safety (Input to Jog-Dial can be Disabled)
- * Easily calibrated for accurate temperature control and display

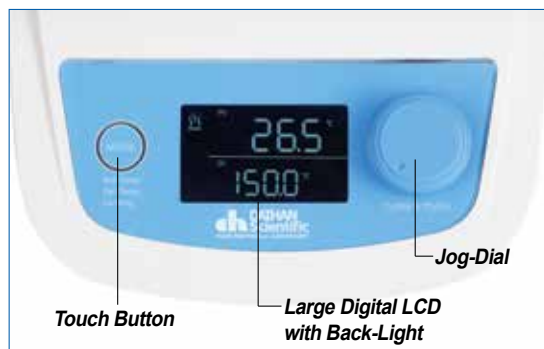

Controller of “MaXtable™ H20”

Specifications & Ordering information

Spec.	Model	“MaXtable™ H20” (Only Unit)	“MaXtable™ H20-set” (included Standard Block)
Controller		Single Digital Fuzzy Controller	
Useful Block		Interchangeable Block(90×120×h60mm) for Various Tubes	
included Standard Block		None(Only Heating Block Unit)	48 holes×for 1.5/ 2ml Centri. Tube
Heater		Molded Heater(300W)	
Dimension(mm) & Weight(kg)		Unit : 178×226×h138, Block : 90×120×h60	
Temp. Range & Accuracy		Ambient +5°C to 150°C, ±0.1°C at 37°C, ±0.2°C at 90°C, ±0.4°C at 135°C	
Heat-Up Speed & Sensor		Approx. 5°C/min, PT100	
Safety Circuit		Over Temp. and Over Current Protector, Sensor Error Detector	
Timer with Alarm		99hr 59min, Alarm (Error Status and Timer - end)	
Display		Digital LCD with Back-Light Function	
Material		Unit : PPS & BAS(HF380), Block : Anodized Aluminum	
Included Standard Acce.		Block Extraction Tool	
Packing Size & Gross Weight		230×290×h245 mm, 2.2 kg	230×355×h245 mm, 3.5 kg
Power Consumption		300 W	
Electric Reqts.		1 Phase, AC 120V, 60Hz or AC 230V, 50 / 60Hz	
Cat. No.	230V	DH.WHB02000	DH.WHB02100
	120V	DH.WHB02001	DH.WHB02101
Price, Each. ₩			

* Other Specifications are available upon Customer's Request.



Included Block (3) “BLC 548” 48holes for 1.5/2ml & Removal Tool

Optional Interchangeable Anodized Aluminum Block (90×120×h60mm)

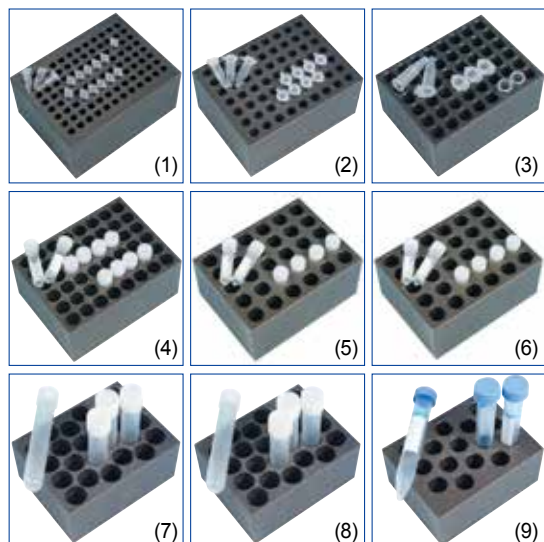

- DH.WHB510596 (1) for 0.2ml PCR Tube, (φ6×h16mm)×96 holes, “BLC596”
- DH.WHB510570 (2) for 0.5ml Centri. Tube, (φ7.7×h29.5mm)×63 holes, “BLC570”
- DH.WHB511548 (3) for 1.5/2ml Centri. Tube, (φ11×h35mm)×48 holes, “BLC548” (* included in the “H20-Set”)
- DH.WHB521248 (4) for φ 12mm Test Tube, (φ 12×h35mm)×48 holes, “BLT248”
- DH.WHB521335 (5) for φ 13mm Test Tube, (φ 13×h47mm)×30 holes, “BLT335”
- DH.WHB521535 (6) for φ 15mm Test Tube, (φ 15×h47mm)×30 holes, “BLT535”
- DH.WHB521628 (7) for φ 16.5mm Test Tube, (φ 16.5×h47mm)×24 holes, “BLT628”
- DH.WHB521828 (8) for φ 18mm Test Tube, (φ 18×h47mm)×24 holes, “BLT828”
- DH.WHB531515 (9) for 15ml Conical Tube, (φ 16×h47mm)×15 holes, “BLC515”
- DH.WHB535008 (10) for 50ml Conical Tube, (φ 28.7×h47mm)×8 holes, “BLC008”
- DH.WHB500102 (11) Spare ; Block Removal Tool, Easy Handling

Ea. Price, ₩

DAIHAN® High-performance Heating Block/Dry Bath Incubator "HB-96D", Heating, Dual-type
 With Fuzzy Control, Molded Heater, Modular Anodized Aluminum Blocks, Acrylic Lid, Touch-button Controller, up to 150°C, ±0.1°C
 히팅 블록, 디지털 퍼지 컨트롤 시스템, 듀얼 조절기/블럭, 일체형 주물 히터, 블럭 교체 가능, 아크릴 리드/ 블럭용 집게 포함



2-Year Warranty

Heating Block/Dry Bath, Dual Control System
 "HB-96D-set"



(3) "BLC548"



(11) "BLE101"

Included Anodized Aluminum Block & Tongs

- Made in Korea ■ CE Certified ■ PL (Product Liability) Insurance
- with Certificate & Traceability : Controlled by Serial Number, Certificate, Delivery-information, and Traceable Data Base System
- Designed for Multi-functional Dry Block Heater
- Dual Controller & Block
- Patented Jog-Shuttle Control System and Digital LCD with Back-Light Function
- * Ideal for Enzyme Reactions, Inactivation of Sera, Incubation and Other Laboratory Procedures
- * Precise Temperature Control : ±0.1°C at 37°C, ±0.2°C at 90°C, ±0.4°C at 135°C
- * User Self-Compensation Function to offset between Actual and Displayed Temperature. (±10.0°C)
- * Over Temperature & Over Current Protection and Sensor Error Detection
- * Digital Timer Included : up to 99hr 59min (Operation Time + Delay Time)
- * Storage Function of Temperature and Timer setting values * Modular Block
- * Alarm Function : Error Status and Timer-end * Various kind of Blocks are offered (Optional)
- * Locking Mode Supported for Experimental Safety (Input to Jog-Shuttle can be Disabled)
- * The Block Removal Tongs are Included for Easy Handling

Specifications & Ordering information

Spec.	Model	"HB-96D" (Only Unit)	"HB-96D-set" (included Standard Block)
Controller		Dual Digital Fuzzy Controller	
Useful Block		Interchangeable Block(90×120×h60mm) for Various Tubes	
included Standard Block		None(Only Heating Block Unit)	2×48 holes×for 1.5/2ml Centri. Tube
Heater		Molded Heater(300W)×2ea	
Dimension(mm)		Unit : 285×250×h155, Block : (90×120×h60)×2ea	
Temp. Range, & Accuracy		Ambient +5°C to 150°C, ±0.1°C at 37°C, ±0.2°C at 90°C, ±0.4°C at 135°C	
Heat-Up Speed & Sensor		Approx. 5°C/min, PT100	
Safety Circuit		Over Temp. and Over Current Protector, Sensor Error Detector	
Timer with Alarm		99hr 59min, Alarm (Error Status and Timer - end)	
Display		Digital LCD with Back-Light Function	
Material		Unit : Stainless-steel (# 304) & Powder Coated steel, Block : Anodized Aluminum	
Included Standard Acce.		Block Tongs "BLE101" and Block Cover	
Packing Size & Gross Weight		400×270×h200 mm, 6 kg	
Power Consumption		600 W	
Electric Reqts.		1 Phase, AC 120V, 60Hz or AC 230V, 50 / 60Hz	
Cat. No.	230V	DH.WHB00198	DH.WHB00199
	120V	DH.WHB02198	DH.WHB02199
Price, Each. ₩			

* Other Specifications are available upon Customer's Request.

Optional Interchangeable Anodized Aluminum Block (90×120×h60mm)

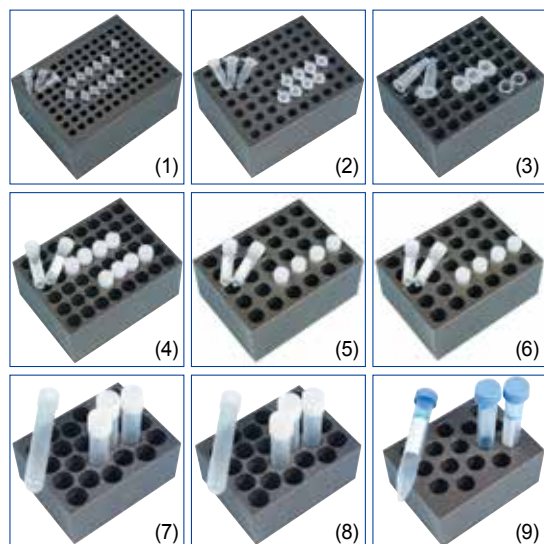

- | | |
|--------------|--|
| DH.WHB510596 | (1) for 0.2ml PCR Tube, (φ6×h16mm)×96 holes, "BLC596" |
| DH.WHB510570 | (2) for 0.5ml Centri. Tube, (φ7.7×h29.5mm)×63 holes, "BLC570" |
| DH.WHB511548 | (3) for 1.5/2ml Centri. Tube, (φ11×h35mm)×48 holes, "BLC548"
(* included in the "HB-96D-Set") |
| DH.WHB521248 | (4) for φ12mm Test Tube, (φ12×h35mm)×48 holes, "BLT248" |
| DH.WHB521335 | (5) for φ13mm Test Tube, (φ13×h47mm)×30 holes, "BLT335" |
| DH.WHB521535 | (6) for φ15mm Test Tube, (φ15×h47mm)×30 holes, "BLT535" |
| DH.WHB521628 | (7) for φ16.5mm Test Tube, (φ16.5×h47mm)×24 holes, "BLT628" |
| DH.WHB521828 | (8) for φ18mm Test Tube, (φ18×h47mm)×24 holes, "BLT828" |
| DH.WHB531515 | (9) for 15ml Conical Tube, (φ16×h47mm)×15 holes, "BLC515" |
| DH.WHB535008 | (10) for 50ml Conical Tube, (φ28.7×h47mm)×8 holes, "BLC008" |
| DH.WHB500101 | (11) Spare ; Block Extraction Tongs, "BLE101" |

Ea. Price, ₩

DAIHAN® High-performance Heating Block/Dry Bath Incubator-Heating & Cooling “HB-R48”

With Digital PID Control, Acrylic Lid, Precise Temperature Control, Modular Anodized Aluminum Block, $-5^{\circ}\text{C}\sim 95^{\circ}\text{C}$, $\pm 0.1^{\circ}\text{C}$ Peltier Cooling System, Digital Timer, Interchangeable Blocks, **히팅 / 쿨링 블록, 블록 교체 가능, 아크릴 리드/ 블록용 집게 포함**



“HB-R48-Set”
with Block “BLC548” for 1.5/2ml Centrifuge Tube × 48 holes

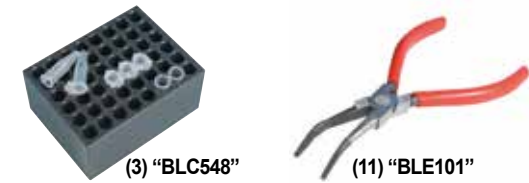

Included Anodized Aluminum Block & Tongs

- Made in Korea ■ CE Certified ■ PL(Product Liability) Insurance
- with Certificate & Traceability : Controlled by Serial Number, Certificate, Delivery-information, and Traceable Data Base System
- Designed for Multi-Function : Enzyme Reactions, Inactivation of Sera, Incubation and Other Laboratory Procedures.
- Patented Jog-Shuttle Control System and Digital LCD with Back-Light Function
- * User Self-Compensation Function to offset between Actual and Displayed Temperature. ($\pm 10.0^{\circ}\text{C}$)
- * Storage Function of Temperature and Timer setting values
- * Locking Mode Supported for Experimental Safety (Input to Jog-Shuttle can be Disabled)

Specifications & Ordering information

Spec.	Model	“HB-R48” (Only Unit)	“HB-R48-set” (included Standard Block)
Controller		Digital Fuzzy Controller	
Useful Block		Interchangeable Block(90×120×h60mm) for Various Tubes	
included Standard Block		None(Only Heating Block Unit)	48 holes×for 1.5/2ml Centri. Tube
Dimension : Unit & Block		185×230×h220mm, and 90×120×h60mm	
Cooling		Two Peltier Modules	
Cool-Down Speed		2.3°C/min. between 95°C to 25°C, 0.5°C/min. between 25°C to -5°C	
Heater and Sensor		300W (Molded Heater), PT100	
Temp. Range, & Accuracy		-5°C to 95°C , and $\pm 0.1^{\circ}\text{C}$ at 37°C , $\pm 0.2^{\circ}\text{C}$ at 90°C	
Heat-Up Speed		Approx. 5°C/min	
Safety Device		Over Temp. and Over Current Protector, Sensor Error Detector	
Timer with Alarm		99hr 59min, Alarm (Error Status and Timer - end)	
Display		Digital LCD with Back-Light Function	
Material	Internal & External Block	Stainless-steel (#304), and Powder Coated steel	
		Anodized Aluminum	
Included Standard Acce.		Block Tongs “BLE101” and Block Cover	
Packing Size, Gross Weight		350×220×h310mm, 9 kg	
Power Consumption		450 W	
Electric Reqts.		1 Phase, AC 120V, 60Hz or AC 230V, 50 / 60Hz	
Cat. No.	230V	DH.WHB00248	DH.WHB00249
	120V	DH.WHB02248	DH.WHB02249
Price, Each. ₩			

* Other Specifications are available upon Customer's Request.

Optional Interchangeable Anodized Aluminum Block (90×120×h60mm)

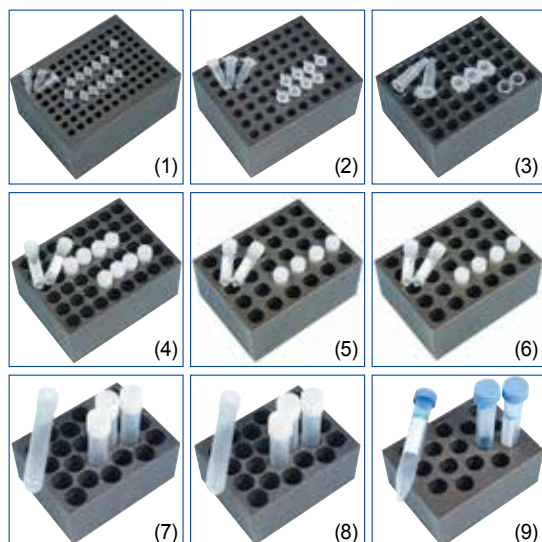

- | | |
|--------------|--|
| DH.WHB510596 | (1) for 0.2ml PCR Tube, ($\phi 6 \times h16\text{mm}$)×96 holes, “BLC596” |
| DH.WHB510570 | (2) for 0.5ml Centri. Tube, ($\phi 7.7 \times h29.5\text{mm}$)×63 holes, “BLC570” |
| DH.WHB511548 | (3) for 1.5/2ml Centri. Tube, ($\phi 11 \times h35\text{mm}$)×48 holes, “BLC548”
(* included in the “HB-R48-Set”) |
| DH.WHB521248 | (4) for $\phi 12\text{mm}$ Test Tube, ($\phi 12 \times h35\text{mm}$)×48 holes, “BLT248” |
| DH.WHB521335 | (5) for $\phi 13\text{mm}$ Test Tube, ($\phi 13 \times h47\text{mm}$)×30 holes, “BLT335” |
| DH.WHB521535 | (6) for $\phi 15\text{mm}$ Test Tube, ($\phi 15 \times h47\text{mm}$)×30 holes, “BLT535” |
| DH.WHB521628 | (7) for $\phi 16.5\text{mm}$ Test Tube, ($\phi 16.5 \times h47\text{mm}$)×24 holes, “BLT628” |
| DH.WHB521828 | (8) for $\phi 18\text{mm}$ Test Tube, ($\phi 18 \times h47\text{mm}$)×24 holes, “BLT828” |
| DH.WHB531515 | (9) for 15ml Conical Tube, ($\phi 16 \times h47\text{mm}$)×15 holes, “BLC515” |
| DH.WHB535008 | (10) for 50ml Conical Tube, ($\phi 28.7 \times h47\text{mm}$)×8 holes, “BLC008” |
| DH.WHB500101 | (11) Spare ; Block Extraction Tongs, “BLE101” |

Ea. Price, ₩

DAIHAN® Precise High-temp & Refrigerated/Heating Bath Circulator, -35+250°C

정밀 고온 배스겸용 고온 써클레이터와 냉동/가열 배스 겸용 써클레이터



High Temp Bath Circulator



Refrigerated/Heating Bath Circulator

※ See the “Bath Circulator” Section for the Details.

250°C High-temp Bath Circulator, 8 · 12 · 22 · 30 Lit	P. 34
-25+150°C Refrigerated/Heating Bath Circulator, 8 · 12 · 22 · 30 Lit	P. 35
-35+150°C Refrigerated/Heating Bath Circulator, 8 · 12 · 22 · 30 Lit	P. 36

Therminol D12® -85+230°C Best COOL-/HEAT-ing Transfer Fluid, Synthetic Hydrocarbon Mixture

For Low/High-Temp Baths, Clearly Harmless Liquid, Low Odor FDA Grade, 4/18/200Lit, 냉매/열매 겸용 합성 탄화수소혼합물(액체)



(1) 4Lit

(2) 18Lit

- Supplied by “Eastman” USA ■ Clear, Water white Liquid / Non-Toxic / Low-Smell, FDA-Grade.
- The Best Circulation Properties / Thermal Stability.
- The Lowest Viscosity, cP ▶ (1) -50°C : 12cP, (2) 100°C : 0.46cP, (3) 200°C : 0.19cP, (4) 230°C : 0.16cP
- * Specific Gravity : 0.759 at 25°C * Autoignition Temp : 247°C * Flash Point : 62°C
- * Freezing Point : -94°C * Boiling Point(90%) : 204°C * Do not use for Silicone Tube
- * Package : (1) 4Lit and (2) 18Lit PE Square Bottle / Subdivision, Original-200Lit Steel Drum / 155kg

SL.CirD12.1 (1) “Therminol D12” Cool/Heat Transfer Fluid, -85 +230°C, 4 Lit

4ℓ .dh pk	₩
-----------	---

4Lit	
------	--

SL.CirD12.2 (2) “Therminol D12” Cool/Heat Transfer Fluid, -85 +230°C, 18Lit

18ℓ .dh pk	₩
------------	---

18Lit	
-------	--

※ 운임 약 ₩ 25,000 별도!

Drum Price, ₩	
---------------	--

SL.CirD12 “Therminol D12” Cool/Heat Transfer Fluid, -85 +230°C, 200Lit/Drum

200Lit	
--------	--



Heating Transfer Fluid, 20Lit

SYN THERM 22L® -5+320°C Heating Transfer Fluid, Synthetic Alkylbenzene Derivative

For Low- & High-Temp Circulation, 알킬벤젠계 합성열매 NEW

■ Made in Korea

* Hazards Identification of MSDS(Material Safety Data Sheet) :

- H315 Causes Skin Irritation
- H319 Causes Serious Eye Irritation
- H335 May Cause Respiratory Irritation
- H336 May Cause Drowsiness or Dizziness

* Kinematic Viscosity & Density :

- (1) at 0°C : 22.7cSt, 0.885kg/ℓ
- (2) at 40°C : 21.80cSt, 0.859kg/ℓ
- (3) at 80°C : 6.09cSt, 0.834kg/ℓ
- (4) at 140°C : 6.09cSt, 0.795kg/ℓ
- (5) at 200°C : 1.10cSt, 0.756kg/ℓ
- (6) at 260°C : 0.74cSt, 0.718kg/ℓ

SL.SYN22L SYN THERM 22L® Heating Transfer Fluid -5+320°C, 20Lit

Pk.	Price, ₩
-----	----------

20Lit	
-------	--

DAIHAN® -30+200°C Precise Refrigerated Heating External Circulator "MaXircu™ WHR", Fill-10 · 18 · 25 Lit
 Ideal for Evaporator/Reactor &c. Heating & Cooling Line, with Pre-Cooling Sys, Used with External Direct Contact K-type Temp. Probe(Optional)
 With High Quality Magnetic Pump, Flow 20 · 40 · 60 Lit/min, Lift 38m, ±0.2°C, 정밀 고온/냉동 겸용 외부 써클레이터



-30°C ~ +200°C Refrigerated / Heating External Circulator, "MaXircu™ WHR-50"



"MaXircu™ WHR" in the Reactor System.

※ Note : Cooling Transfer Fluid Should be an Antifreezing Solution

- Made in Korea
- PL (Product Liability) Insurance
- Max. Lift : 38m
- with Certificate & Traceability : Controlled by Serial Number, Certificate, Delivery-information, and Traceable Data Base System
- Digital Fuzzy Control System Implementing Superior Temperature Accuracy
- Patented Jog-Dial Control System and Digital LCD with Back-Light Function.
- * Innovated Powerful Circulation Pump ensures Temp. Uniformity : Internal and External Circulation (Max Flow Rate : 20 · 40 · 60 Lit/min)
- * Assembly-type Safety Connection Ports/Pipe (for Fluid In/Out-let : ISO RC 1" Screw Stainless-steel.)
- * With High Quality Shock-proof Caster for Convenient and Safe Moving.
- * Embedded External Nozzle Part for the Prevention of Nozzle Damaged.
- * Stainless-steel Internal Bath for Prevention of Corrosion.
- * Independently 3-systems : Refrigerating System, Heating System, Pre-Cooling System.
- * Urethane Foam Insulation
- * Warning and Auto-Stop Function in case of Liquid Shortage.
- * More Faster Cool-down and Heat-up Time
- * Connection with Evaporator or Viscometer is applicable.



Connection Ports

Specifications & Ordering information

Spec.	Model	"MaXircu™ WHR-20" Useful for 5~20Lit Reactor	"MaXircu™ WHR-50" Useful for 20~50Lit Reactor	"MaXircu™ WHR-100" Useful for 50~100Lit Reactor
Temp. Range & Stability		-30°C ~ +200°C-Range, ±0.2°C(at 15°C)-Stability		
Heat-Fluid Filling Volume		10 Lit max	18 Lit max	25 Lit max
Useful for 5~100Lit Reactor		for 5~20Lit Reactor	for 20~50Lit Reactor	for 50~100Lit Reactor
Refrigerator Capacity		4.5 kW	7.5 kW	18 kW
Heater		2.5 kW	6.0 kW	12 kW
Lid & Top Opening Dia.		φ80 mm		
Fluid In/Out-let Connector		ISO RC 1" (English System AG 1") Thread, Stainless-steel		
Pump Power, Max. Flow Rate		20 Lit/min	40 Lit/min	60 Lit/min
Lift Height, m Max. Pressure & Lift		Max Pressure : 4 bar, Max. Lift : 38m		
Cooling Capacity	at +15°C	8.1 kW	13.1 kW	22.7 kW
	at 0°C	4.3 kW	7.3 kW	12.6 kW
	at -25°C	1.4 kW	3.1 kW	5.45 kW
External Dimension		600×750×h1100 mm	650×850×h1300 mm	750×900×h1500 mm
Optional External Temp. Sensor K-type Probe		Can be used with External Direct Contact K-type Temp. Probe. (Optional)		
Material		Internal : Stainless-steel, External : Powder Coated steel		
Electrical Reqts.		3Phase 380V		
Cat. No.	60Hz	DH.WHR0020	DH.WHR0050	DH.WHR0100
	50Hz	DH.WHR0025	DH.WHR0055	DH.WHR0150
Price, Each. ₩				

* Other Specifications are available upon Customer' s Request.

※ 운임 약 ₩ 20,000 별도!



(1) & (2)



(3)

Insulated Silicone & Teflon PFA Circulation Hose, Id φ 10 ~ 19mm, L1/1.5m

- Supplied by SciLab Korea
- * φ37mm Black NBR Foam Insulated Silicone or PFA-Hose
- * Silicone Vacu-Hose : id 10×od 13mm, id 15×od 20mm, id 18×od 24mm, 220°C
- * PFA Hose : id 10×od 12mm & PTFE Hose : id 15×od 16mm, id 19×od 21mm, -100 + 260°C

(1) Insulated Silicone Hose, 220°C

SL.Tub	Material	Length	dh Pk. Price, ₩
SL.Tub4021	Sili-hose, id 10mm, L1m	1m	
SL.Tub4022	, L1.5m	1.5m	
SL.Tub4023	, id 15mm, L1m	1m	
SL.Tub4024	, L1.5m	1.5m	
SL.Tub4025	, id 18mm, L1m	1m	
SL.Tub4026	, L1.5m	1.5m	

(2) Insulated PFA Hose, 260°C

SL.Tub	Material	Length	dh Pk. Price, ₩
SL.Tub4031	PFA-hose, id 10mm, L1m	1m	
SL.Tub4032	, L1.5m	1.5m	
SL.Tub4033	PTFE-hose, id 15mm, L1m	1m	
SL.Tub4034	, L1.5m	1.5m	
SL.Tub4035	, id 19mm, L1m	1m	
SL.Tub4036	, L1.5m	1.5m	

(3) Best Insulatedly & Flexible Stainless-steel Circulation Hose, Id φ 17mm, L1m, 360°C

SL.Tub	Material	Ea. Price, ₩
SL.Tub7021	Flexible Stainless-steel Circulation Hose, id 17×od 60mm, L1m	

※ See the Preceding Page for Cooling / Heating Transfer Fluid

Heating Mantle

For Beaker - Basic-type	P. 86
- Stirring-type	P. 86
For Flask - Basic-type	P. 87
- Fabric Housing	P. 89
- Remote Control	P. 88~89
- Stirring-type	P. 87
For Reaction Vessel - Basic-type	P. 90
- Remote Control	P. 91
- Stirring-type	P. 90
For Soxhlet/Extraction	P. 92
Heating Tape and Custom Made	P. 93
Heating Product Controller	P. 94



Beaker Basic-type
"WHM12146"



Beaker Stirring-type
"WHM121606"



Flask Basic-type
"WHM12014"



Flask Stirring-type
"WHM12034"



Flask High Temp-type
"WHM12094"



Reaction Flask
"WHM8224"



Fabric Housing
"WHM12114"



Fabric Housing
"WHM121303"



Reaction Vessel
"WHM8153"



Reaction Vessel
"WHM8180"

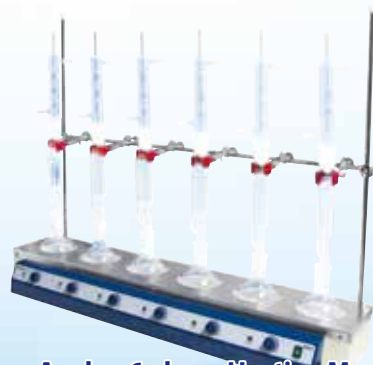

Analog 6 places Heating Mantle
"WHM12293"

Analog Compact Controller
"WHM-C10A"



Digital Feedback Controller
"WHM-C10D"

DAIHAN® Aluminum-case Beaker Heating Mantle, (1) Basic & (2) Stirring-type, 450°C, 100~5,000ml
 With Built-in Temp Controller, with/without Mag-stir Speed Control, with Certi. & Traceability
 비커용 히팅맨틀, 온도 조절기 내장, “기본형” 및 “자석교반형”, Ni-Cr열선 내장

- Made in Korea
- Ideal for All type Beaker
- with Certificate & Traceability : Controlled by Serial Number, Certificate, Delivery-information, and Traceable Data Base System
- Built-in Temp-Controller. Nickel-Chrome Heating Element “Coil-type” : Acid Resistant & Long Life Time.



(1) Basic-type Beaker Mantle with Controller

(1) Basic-type Beaker Mantle, Built-in Temp. Controller

* With a Device* for Holding a Optional Stainless-steel Rod ϕ 12.7 mm for Article Support.

Beakers, ml Dia. ϕ mm	Mantle			Catalog No.		Ea. Price, ₩
	Watts (W)	Inside Depth	Outside $\phi \times h$ (mm)	with 230V	with 120V	
100ml, ϕ 50~52	80 W	40 mm	ϕ 145 \times h140	DH.WHM12141	DH.WHM12151	
250ml, ϕ 68~70	140 W	65 mm	ϕ 145 \times h140	DH.WHM12142	DH.WHM12152	
400ml, ϕ 79~81	240 W	70 mm	ϕ 145 \times h140	DH.WHM12143	DH.WHM12153	
600ml, ϕ 88~90	240 W	75 mm	ϕ 145 \times h140	DH.WHM12144	DH.WHM12154	
800ml, ϕ 98~100	300 W	90 mm	ϕ 190 \times h165	DH.WHM12145	DH.WHM12155	
1,000ml, ϕ 105~108	350 W	90 mm	ϕ 190 \times h165	DH.WHM12146	DH.WHM12156	
2,000ml, ϕ 130~132	450 W	125 mm	ϕ 199 \times h190	DH.WHM12147	DH.WHM12157	
3,000ml, ϕ 151~153	550 W	160 mm	ϕ 270 \times h235	DH.WHM12148	DH.WHM12158	
4,000ml, ϕ 160~162	700 W	160 mm	ϕ 270 \times h235	DH.WHM121481	DH.WHM121581	
5,000ml, ϕ 169~171	800 W	160 mm	ϕ 270 \times h235	DH.WHM12149	DH.WHM12159	



(2) Stirring-type Beaker Mantle with a Stir-Bar

(2) Stirring-type Beaker Mantle, Built-in 50~75rpm Mag-stir Speed & Temp. Controller

* With a Device* for Holding a Optional Stainless-steel Rod ϕ 12.7 mm for Article Support.

* With 1ea \times PTFE Octagonal Magnetic Stirrer Bar, L38mm

Beakers, ml Dia. ϕ mm	Mantle			Catalog No.		Ea. Price, ₩
	Watts (W)	Inside Depth	Outside $\phi \times h$ (mm)	with 230V	with 120V	
100ml, ϕ 50~52	80 W	45 mm	ϕ 145 \times h140	DH.WHM121601	DH.WHM121611	
250ml, ϕ 68~70	140 W	70 mm	ϕ 190 \times h165	DH.WHM121602	DH.WHM121612	
400ml, ϕ 79~81	240 W	70 mm	ϕ 190 \times h165	DH.WHM121603	DH.WHM121613	
600ml, ϕ 88~90	240 W	72 mm	ϕ 190 \times h165	DH.WHM121605	DH.WHM121615	
1,000ml, ϕ 105~108	350 W	105 mm	ϕ 190 \times h190	DH.WHM121606	DH.WHM121616	
2,000ml, ϕ 130~132	450 W	140 mm	ϕ 270 \times h235	DH.WHM121607	DH.WHM121617	
3,000ml, ϕ 151~153	550 W	140 mm	ϕ 270 \times h235	DH.WHM121608	DH.WHM121618	
4,000ml, ϕ 160~162	700 W	170 mm	ϕ 325 \times h270	DH.WHM121609	DH.WHM121619	
5,000ml, ϕ 169~171	800 W	170 mm	ϕ 325 \times h270	DH.WHM121610	DH.WHM121620	



Optional Stainless-steel Rod, Holder & Clamp

- DH.WHP503037 (3) Stand Rod, ϕ 12.7 \times L520mm, “RD300”, for Heating Mantles
- DH.WHP503012 (4) Holder / Clamp / Clip, “CL220”, for Temp. Sensor

Ea. Price, ₩

DAIHAN® Aluminium-case Flask Heating Mantle, (1) Basic & (2) Stirring-type, 450°C, 50~20,000ml
 With Built-in Temp Controller, with/without Mag-stir Speed Control, with Certi. & Traceability
 라운드플라스크용 히팅맨틀, 온도 조절기 내장, "기본형" 및 "자석교반형", Ni-Cr열선 내장

- Made in Korea
- Ideal for All type Round Flask
- with Certificate & Traceability : Controlled by Serial Number, Certificate, Delivery-information, and Traceable Data Base System
- Built-in Temp-Controller. Nickel-Chrome Heating Element "Coil-type" : Acid Resistant & Long Life Time.
- With Powder-coated Steel-case : 10-/20-Lit



(1) Basic-type Flask Mantle with Controller



(2) Stirring-type Flask Mantle with a Stir-Bar

(1) Basic-type Flask Mantle, Built-in Temp. Controller

* Heating Mantles for 50ml~6,000ml Flask are with a Device* for Holding a Optional Stainless-steel Rod ϕ 12.7 mm for Article Support.

Flasks, ml Dia. ϕ mm	Mantle			Catalog No.		Ea. Price, ₩
	Watts (W)	Inside Depth	Outside $\phi \times h$ (mm)	with 230V	with 120V	
50ml, ϕ 49 ~ 52	90 W	30 mm	ϕ 145 \times h140	DH.WHM12010	DH.WHM12020	
100ml, ϕ 63 ~ 66	90 W	50 mm	ϕ 145 \times h140	DH.WHM12011	DH.WHM12021	
250ml, ϕ 83 ~ 86	160 W	55 mm	ϕ 145 \times h140	DH.WHM12012	DH.WHM12022	
500ml, ϕ 102 ~ 105	250 W	70 mm	ϕ 190 \times h165	DH.WHM12013	DH.WHM12023	
1,000ml, ϕ 130 ~ 133	350 W	85 mm	ϕ 190 \times h165	DH.WHM12014	DH.WHM12024	
2,000ml, ϕ 165 ~ 169	490 W	100 mm	ϕ 270 \times h200	DH.WHM12015	DH.WHM12025	
3,000ml, ϕ 184 ~ 187	600 W	110 mm	ϕ 270 \times h200	DH.WHM12016	DH.WHM12026	
4,000ml, ϕ 206 ~ 208	750 W	140 mm	ϕ 325 \times h226	DH.WHM8037	DH.WHM8037.1	
5,000ml, ϕ 221 ~ 225	850 W	130 mm	ϕ 325 \times h226	DH.WHM12017	DH.WHM12027	
6,000ml, ϕ 234 ~ 237	850 W	130 mm	ϕ 325 \times h226	DH.WHM12018	DH.WHM12028	
10Lit, ϕ 278 ~ 282	1,500 W	205 mm	ϕ 400 \times h260	DH.WHM12019	DH.WHM12029	
20Lit, ϕ 344 ~ 350	2,000 W	220 mm	ϕ 460 \times h280	DH.WHM12070	DH.WHM12071	

(2) Stirring-type Flask Mantle, Built-in 50~75rpm Mag-stir Speed & Temp. Controller

- * Heating Mantles for 50ml~6,000ml Flask are with a Device* for Holding a Optional Stainless-steel Rod ϕ 12.7 mm for Article Support.
- * 10-/20-Lit models Square-type Outside Shape.
- * With 1ea \times PTFE Oval-type Magnetic Stirrer Bar, L25mm.

Flasks, ml Dia. ϕ mm	Mantle			Catalog No.		Ea. Price, ₩
	Watts (W)	Inside Depth	Outside $\phi \times h$ (mm)	with 230V	with 120V	
50ml, ϕ 49 ~ 52	90 W	45 mm	ϕ 145 \times h140	DH.WHM12030	DH.WHM12040	
100ml, ϕ 63 ~ 66	90 W	45 mm	ϕ 145 \times h140	DH.WHM12031	DH.WHM12041	
250ml, ϕ 83 ~ 86	160 W	45 mm	ϕ 145 \times h140	DH.WHM12032	DH.WHM12042	
500ml, ϕ 102 ~ 105	250 W	70 mm	ϕ 190 \times h165	DH.WHM12033	DH.WHM12043	
1,000ml, ϕ 130 ~ 133	350 W	90 mm	ϕ 190 \times h190	DH.WHM12034	DH.WHM12044	
2,000ml, ϕ 165 ~ 169	490 W	105 mm	ϕ 270 \times h200	DH.WHM12035	DH.WHM12045	
3,000ml, ϕ 184 ~ 187	600 W	105 mm	ϕ 270 \times h200	DH.WHM12036	DH.WHM12046	
4,000ml, ϕ 206 ~ 208	750 W	135 mm	ϕ 325 \times h226	DH.WHM8057	DH.WHM8057.1	
5,000ml, ϕ 221 ~ 224	850 W	130 mm	ϕ 325 \times h226	DH.WHM12037	DH.WHM12047	
6,000ml, ϕ 234 ~ 237	850 W	130 mm	ϕ 325 \times h226	DH.WHM12038	DH.WHM12048	
10Lit, ϕ 278 ~ 282	1,500 W	210 mm	440 \times 510 \times h310	DH.WHM8060	DH.WHM8060.1	
20Lit, ϕ 344 ~ 348	2,000 W	230 mm	440 \times 550 \times h330	DH.WHM8061	DH.WHM8061.1	

Optional Stainless-steel Rod, Holder & Clamp

- DH.WHP503037 (3) Stand Rod, ϕ 12.7 \times L520mm, "RD300", for Heating Mantles
- DH.WHP503012 (4) Holder / Clamp / Clip, "CL220", for Temp. Sensor

Ea. Price, ₩

(3) Stand Rod, "RD300", ϕ 12.7 \times L520mm

(4) Holder / Clamp / Clip for Temp. Probe

DAIHAN® Remotecontrolled Flask Heating Mantle, (1) 450°C Basic & (2) 650°C High Temp-type, 50ml~100Lit
 For Spherical Flask, with Nickel Chrome Heating Element, K-type Thermo-Sensor Integrated, with Certi. & Traceability, Option-Controller
 라운드플라스크용 히팅맨틀, K-타입 온도센서, Ni-Cr열선 내장, 자력교반기와 사용가능, 조절기 별도

- Made in Korea
- Ideal for All type Round Flask and Use with Magnetic Stirrer
- with Certificate & Traceability : Controlled by Serial Number, Certificate, Delivery-information, and Traceable Data Base System
- Optional Remote Thermo Controller, K-type Thermo-Sensor, and Nickel-Chrome Heating Element "Coil-type" : Acid Resistant & Long Life Time.
- Heating Mantles for 50ml~6,000ml Flask are with a Device* for Holding a Optional Stainless-steel Rod ϕ 12.7 mm for Article Support.



(1) 450°C Basic-type



(2) 650°C High Temp.-type



(1) 450°C Basic-type, 50ml~100Lit

① with Aluminum-case, 50~6000ml ② with Powder-coated Steel-case, 10~100Lit

Flasks, ml Dia. ϕ mm	Mantle			Catalog No.		Ea. Price, ₩
	Watts (W)	Inside Depth	Outside $\phi \times h$ (mm)	with 230V	with 120V	
50ml, ϕ 49 ~ 52	90 W	30 mm	ϕ 145 \times h75	DH.WHM12050	DH.WHM12060	
100ml, ϕ 63 ~ 66	90 W	50 mm	ϕ 145 \times h75	DH.WHM12051	DH.WHM12061	
250ml, ϕ 83 ~ 86	160 W	50 mm	ϕ 145 \times h75	DH.WHM12052	DH.WHM12062	
500ml, ϕ 102 ~ 105	250 W	55 mm	ϕ 190 \times h80	DH.WHM12053	DH.WHM12063	
1,000ml, ϕ 130 ~ 133	350 W	85 mm	ϕ 190 \times h110	DH.WHM12054	DH.WHM12064	
2,000ml, ϕ 165 ~ 169	490 W	105 mm	ϕ 270 \times h135	DH.WHM12055	DH.WHM12065	
3,000ml, ϕ 184 ~ 187	600 W	110 mm	ϕ 270 \times h135	DH.WHM12056	DH.WHM12066	
4,000ml, ϕ 206 ~ 208	750 W	135 mm	ϕ 325 \times h165	DH.WHM8078	DH.WHM8078.1	
5,000ml, ϕ 221 ~ 224	850 W	130 mm	ϕ 325 \times h165	DH.WHM12057	DH.WHM12067	
6,000ml, ϕ 234 ~ 237	850 W	130 mm	ϕ 325 \times h165	DH.WHM12058	DH.WHM12068	
10Lit, ϕ 278 ~ 282	1,500 W	205 mm	ϕ 390 \times h240	DH.WHM12073	DH.WHM12083	
20Lit, ϕ 344 ~ 348	2,000 W	220 mm	ϕ 460 \times h280	DH.WHM12074	DH.WHM12084	
50Lit, ϕ 489 ~ 494	4,000 W	310 mm	ϕ 610 \times h390	DH.WHM12075	DH.WHM12085	
100Lit, ϕ 609 ~ 614	6,000 W	370 mm	ϕ 740 \times h450	DH.WHM8084	DH.WHM8084.1	

(2) 650°C High Temp-type, 100ml~10Lit

① with Aluminum-case, 100~6000ml ② with Powder-coated Steel-case, 10Lit

Flasks, ml Dia. ϕ mm	Mantle			Catalog No.		Ea. Price, ₩
	Watts (W)	Inside Depth	Outside $\phi \times h$ (mm)	with 230V	with 120V	
100ml, ϕ 63 ~ 66	160 W	50 mm	ϕ 145 \times h75	DH.WHM12091	DH.WHM12101	
250ml, ϕ 83 ~ 86	250 W	50 mm	ϕ 145 \times h75	DH.WHM12092	DH.WHM12102	
500ml, ϕ 102 ~ 105	350 W	55 mm	ϕ 190 \times h80	DH.WHM12093	DH.WHM12103	
1,000ml, ϕ 130 ~ 133	490 W	85 mm	ϕ 190 \times h110	DH.WHM12094	DH.WHM12104	
2,000ml, ϕ 165 ~ 169	600 W	105 mm	ϕ 270 \times h135	DH.WHM12095	DH.WHM12105	
3,000ml, ϕ 184 ~ 187	750 W	105 mm	ϕ 270 \times h135	DH.WHM12096	DH.WHM12106	
4,000ml, ϕ 206 ~ 208	850 W	125 mm	ϕ 325 \times h165	DH.WHM8097	DH.WHM8097.1	
5,000ml, ϕ 221 ~ 224	1,500 W	130 mm	ϕ 325 \times h165	DH.WHM12097	DH.WHM12107	
6,000ml, ϕ 234 ~ 237	1,500 W	130 mm	ϕ 325 \times h165	DH.WHM12098	DH.WHM12108	
10Lit, ϕ 278 ~ 282	2,000 W	160 mm	ϕ 400 \times h260	DH.WHM8100	DH.WHM8100.1	

Optional Remote Controller

- (a) Analog Remote Controller, 5~100% of Rated Voltage, Up to 1.2kW
- (b) Digital Remote Controller, Ambient +5 ~ 700°C, \pm 1°C Uniformity at Set Temp.

Cat. No		Ea. Price, ₩
with 230V	with 120V	
DH.WHM13500	DH.WHM23500	
DH.WHM12500	DH.WHM22500	

Optional Temp. Probe & Stand Rod, Holder, Clamp for Digital Temp. Remote Controller

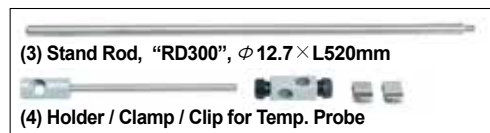
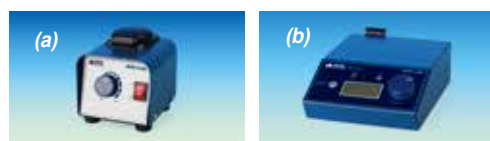

- DH.WHP503040 Direct Contact Temp. Probe, K-type, "SS300", L250 \times ϕ 4.8 mm
- DH.WHP503050 Direct Contact Temp. Probe, K-type, "SS400", L380 \times ϕ 4.8 mm
- DH.WHP503041 Direct Contact Temp. Probe, K-type, "SS310", Teflon Coated, L250 \times ϕ 5 mm
- DH.WHP503051 Direct Contact Temp. Probe, K-type, "SS410", Teflon Coated, L380 \times ϕ 5 mm
- DH.WHP503037 (3) Stand Rod, ϕ 12.7 \times L520mm, "RD300", for Heating Mantles
- DH.WHP503012 (4) Holder / Clamp / Clip, "CL220", for Temp. Sensor

Ea. Price, ₩

DAIHAN® Remotecontrolled Reaction Flask Heating Mantle, Bottom Outlet-type, 450°C, 2,000ml~50Lit
 With Nickel Chrome Heating Element, K-type Thermo-sensor Integrated, with Certi. & Traceability, Option-Controller
 반응조용 히팅맨틀, 반응조 라운드 플라스크용, K-type 온도센서, Ni-Cr열선 내장, 조절기 별도



- Made in Korea
- Ideal for All type Reaction Flasks
- Controlled by Serial Number, Certificate, Delivery-information, and Traceable Data Base System
- Nickel-Chrome Heating Element "Coil-type" : Acid Resistant & Long Life Time.
- With a Device* for Holding a Optional Stainless-steel Rod ϕ 12.7 mm for Article Support.
- Optional Remote Thermo Controller, K-type Thermo-Sensor

Flasks, ml Dia. ϕ mm	Mantle			Catalog No.		Ea. Price, ₩
	Watts (W)	Inside Depth	Outside $\phi \times h$ (mm)	with 230V	with 120V	
2,000ml, ϕ 165 ~ 169	550 W	110 mm	ϕ 270 \times h135	DH.WHM8222	DH.WHM8222.1	
3,000ml, ϕ 184 ~ 186	550 W	130 mm	ϕ 270 \times h165	DH.WHM8232	DH.WHM8232.1	
5,000ml, ϕ 224 ~ 226	800 W	135 mm	ϕ 325 \times h165	DH.WHM8233	DH.WHM8233.1	
10Lit, ϕ 278 ~ 282	1400 W	200 mm	ϕ 400 \times h250	DH.WHM8226	DH.WHM8226.1	
20Lit, ϕ 348 ~ 352	2000 W	230 mm	ϕ 440 \times h290	DH.WHM8227	DH.WHM8227.1	
50Lit, ϕ 480 ~ 484	4000 W	300 mm	ϕ 625 \times h360	DH.WHM8228	DH.WHM8228.1	

DAIHAN® Fabric-Housed Heating Mantle, (1) Self Standing-base & (2) Top Cover, 450°C, 50ml~100Lit
 For Spherical Flask, with Nickel Chrome Heating Element, Option-Controller, with Certi. & Traceability
 직물케이스 히팅맨틀, Ni-Cr열선 내장, 자력교반기와 사용가능, 조절기 별도

- Made in Korea
- Ideal for All type Round Flask and Use with Magnetic Stirrer
- with Certificate & Traceability : Controlled by Serial Number, Certificate, Delivery-information, and Traceable Data Base System
- Built-in Temp-Controller. Nickel-Chrome Heating Element "Coil-type" : Acid Resistant & Long Life Time.



(1) Self Standing-base Mantle

Flasks, ml Dia. ϕ mm	Mantle			Catalog No.		Ea. Price, ₩
	Watts (W)	Inside Depth	Outside $\phi \times h$ (mm)	with 230V	with 120V	
50ml, ϕ 49 ~ 52	90 W	30 mm	ϕ 100 \times h50	DH.WHM12110	DH.WHM12120	
100ml, ϕ 63 ~ 66	90 W	50 mm	ϕ 120 \times h70	DH.WHM12111	DH.WHM12121	
250ml, ϕ 83 ~ 86	160 W	55 mm	ϕ 150 \times h80	DH.WHM12112	DH.WHM12122	
500ml, ϕ 102 ~ 105	250 W	75 mm	ϕ 180 \times h100	DH.WHM12113	DH.WHM12123	
1,000ml, ϕ 130 ~ 133	350 W	90 mm	ϕ 210 \times h115	DH.WHM12114	DH.WHM12124	
2,000ml, ϕ 165 ~ 169	490 W	105 mm	ϕ 250 \times h130	DH.WHM12115	DH.WHM12125	
3,000ml, ϕ 184 ~ 187	600 W	115 mm	ϕ 270 \times h140	DH.WHM12116	DH.WHM12126	
4,000ml, ϕ 206 ~ 208	750 W	120 mm	ϕ 310 \times h160	DH.WHM8108	DH.WHM8108.1	
5,000ml, ϕ 221 ~ 224	850 W	135 mm	ϕ 310 \times h160	DH.WHM12117	DH.WHM12127	
6,000ml, ϕ 234 ~ 237	850 W	135 mm	ϕ 310 \times h160	DH.WHM12118	DH.WHM12128	
10Lit, ϕ 278 ~ 282	1,500 W	205 mm	ϕ 390 \times h260	DH.WHM12119	DH.WHM12129	



(2) Top Cover only

Flasks, ml Dia. ϕ mm	Mantle		Catalog No.		Ea. Price, ₩
	Watts (W)	Outside $\phi \times h$ (mm)	with 230V	with 120V	
250ml, ϕ 83 ~ 86	90 W	ϕ 136 \times h70	DH.WHM121301	DH.WHM121311	
500ml, ϕ 102 ~ 105	160 W	ϕ 160 \times h77	DH.WHM121302	DH.WHM121312	
1,000ml, ϕ 130 ~ 133	250 W	ϕ 183 \times h90	DH.WHM121303	DH.WHM121313	
2,000ml, ϕ 165 ~ 169	350 W	ϕ 220 \times h107	DH.WHM121304	DH.WHM121314	
3,000ml, ϕ 184 ~ 187	490 W	ϕ 236 \times h210	DH.WHM121305	DH.WHM121315	
4,000ml, ϕ 206 ~ 208	490 W	ϕ 260 \times h130	DH.WHM8117	DH.WHM8117.1	
5,000ml, ϕ 221 ~ 224	600 W	ϕ 280 \times h140	DH.WHM121306	DH.WHM121316	
10Lit, ϕ 278 ~ 282	850 W	ϕ 350 \times h170	DH.WHM121307	DH.WHM121317	
20Lit, ϕ 344 ~ 348	1,500 W	ϕ 420 \times h210	DH.WHM121308	DH.WHM121318	
50Lit, ϕ 489 ~ 494	2,000 W	ϕ 590 \times h290	DH.WHM8121	DH.WHM8121.1	
100Lit, ϕ 609 ~ 614	2,000 W	ϕ 700 \times h340	DH.WHM8122	DH.WHM8122.1	

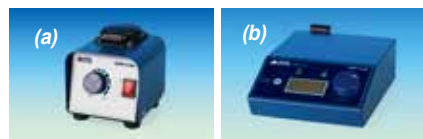

Optional Remote Controller

- (a) Analog Remote Controller, 5~100% of Rated Voltage, Up to 1.2kW
- (b) Digital Remote Controller, Ambient +5 ~ 700°C, \pm 1°C Uniformity at Set Temp.

Cat. No.		Ea. Price, ₩
with 230V	with 120V	
DH.WHM13500	DH.WHM23500	
DH.WHM12500	DH.WHM22500	

DAIHAN® Reaction Vessel Heating Mantle, (1) Basic & (2) Stirring-type, 450°C, 100ml~100Lit

With Built-in Temp Controller, with/without Mag-stir Speed Control, with Certi. & Traceability

반응조용 히팅맨틀, 온도 조절기 내장, “기본형” 및 “자석교반형”, Ni-Cr열선 내장

- Made in Korea
- Powder-coated Steel Housing
- Ideal for All type Reaction Vessel
- with Certificate & Traceability : Controlled by Serial Number, Certificate, Delivery-information, and Traceable Data Base System
- Built-in Temp-Controller. Nickel-Chrome Heating Element “Coil-type” : Acid Resistant & Long Life Time.
- Heating Mantles for 50ml~6,000ml Flask are with a Device* for Holding a Optional Stainless-steel Rod ϕ 12.7 mm for Article Support.



(1) Basic-type Reaction Vessel Heating Mantle with Temp. Controller

(1) Basic-type Reaction Vessel Heating Mantle, Built-in Temp. Controller

① with Aluminum-case, 100~500ml ② with Powder-coated Steel-case, 1000ml ~ 100Lit

Vessels, ml Dia. ϕ × H(cm)	Mantle			Catalog No.		Ea. Price, ₩
	Watts (W)	Inside Depth	Outside ϕ × h(cm)	with 230V	with 120V	
100ml, ϕ 7 × H9	80 W	6.5 cm	ϕ 14.5 × h14.0	DH.WHM8130	DH.WHM8130.1	
250ml, ϕ 7 × H13	140 W	9.0 cm	ϕ 19.0 × h16.5	DH.WHM8131	DH.WHM8131.1	
500ml, ϕ 11 × H12	350 W	9.0 cm	ϕ 19.0 × h16.5	DH.WHM12146	DH.WHM12156	
1,000ml, ϕ 11 × H20	350 W	16.0 cm	ϕ 19.0 × h26.0	DH.WHM8133	DH.WHM8133.1	
2,000ml, ϕ 13 × H24	450 W	18.5 cm	ϕ 19.0 × h26.0	DH.WHM8134	DH.WHM8134.1	
2,000ml, ϕ 14 × H27	550 W	24.5 cm	ϕ 20.6 × h30.0	DH.WHM8135	DH.WHM8135.1	
3,000ml, ϕ 13 × H32	550 W	24.5 cm	ϕ 19.0 × h32.0	DH.WHM8136	DH.WHM8136.1	
4,000ml, ϕ 20 × H29	800 W	23.5 cm	ϕ 32.5 × h30.0	DH.WHM8138	DH.WHM8138.1	
5,000ml, ϕ 20 × H29	800 W	23.5 cm	ϕ 32.5 × h30.0			
6,000ml, ϕ 21.5 × H32	800 W	23.5 cm	ϕ 32.5 × h30.0	DH.WHM8139	DH.WHM8139.1	
10Lit, ϕ 21.5 × H45	1,400 W	35.0 cm	ϕ 35.0 × h40.0	DH.WHM8140	DH.WHM8140.1	
10Lit, ϕ 24 × H41	1,400 W	33.0 cm	ϕ 35.0 × h36.0	DH.WHM8141	DH.WHM8141.1	
20Lit, ϕ 25 × H47	2,000 W	40.0 cm	ϕ 35.0 × h45.0	DH.WHM8142	DH.WHM8142.1	
20Lit, ϕ 27 × H45	2,000 W	35.0 cm	ϕ 40.0 × h40.0	DH.WHM8143	DH.WHM8143.1	
20Lit, ϕ 29 × H42	2,000 W	35.0 cm	ϕ 40.0 × h40.0	DH.WHM8144	DH.WHM8144.1	
50Lit, ϕ 31.5 × H81	4,000 W	67.0 cm	ϕ 44.0 × h75.0	DH.WHM8145	DH.WHM8145.1	
100Lit, ϕ 41.5 × H91	6,000 W	75.0 cm	ϕ 55.0 × h83.0	DH.WHM8146	DH.WHM8146.1	



(2) Stirring-type Reaction Vessel Heating Mantle with Temp./Stirring-Controller and 1x Mag Stir bar

(2) Stirring-type Reaction Vessel Heating Mantle, Built-in 50~75rpm Mag-stir Speed & Temp. Controller

* With 1ea × PTFE Oval-type Magnetic Stirrer Bar, L25mm.

* 10-/20-Lit models Square-type Outside Shape.

① with Aluminum-case, 100~500ml ② with Powder-coated Steel-case, 1000ml ~ 20Lit

Vessels, ml Dia. ϕ × H(cm)	Mantle			Catalog No.		Ea. Price, ₩
	Watts (W)	Inside Depth	Outside ϕ × h(cm)	with 230V	with 120V	
100ml, ϕ 7 × H9	80 W	7.0 cm	ϕ 14.5 × h16.5	DH.WHM8150	DH.WHM8150.1	
250ml, ϕ 7 × H13	140 W	9.0 cm	ϕ 14.5 × h18.5	DH.WHM8151	DH.WHM8151.1	
500ml, ϕ 11 × H12	240 W	9.5 cm	ϕ 19.0 × h19.0	DH.WHM8152	DH.WHM8152.1	
1,000ml, ϕ 11 × H20	350 W	16.5 cm	ϕ 19.0 × h26.0	DH.WHM8153	DH.WHM8153.1	
2,000ml, ϕ 13 × H24	450 W	16.5 cm	ϕ 19.0 × h26.0	DH.WHM8154	DH.WHM8154.1	
2,000ml, ϕ 14 × H27	550 W	22.5 cm	ϕ 20.6 × h30.0	DH.WHM8155	DH.WHM8155.1	
3,000ml, ϕ 13 × H32	550 W	22.5 cm	ϕ 19.0 × h32.0	DH.WHM8156	DH.WHM8156.1	
4,000ml, ϕ 20 × H29	800 W	23.5 cm	ϕ 32.5 × h30.0	DH.WHM8158	DH.WHM8158.1	
5,000ml, ϕ 20 × H29	800 W	23.5 cm	ϕ 32.5 × h30.0			
6,000ml, ϕ 21.5 × H32	800 W	23.5 cm	ϕ 32.5 × h30.0	DH.WHM8159	DH.WHM8159.1	
10Lit, ϕ 21.5 × H45	1400 W	40.0 cm	35 × 46 × h48	DH.WHM8160	DH.WHM8160.1	
10Lit, ϕ 24 × H41	1400 W	37.0 cm	35 × 46 × h39.5	DH.WHM8161	DH.WHM8161.1	
20Lit, ϕ 25 × H47	2000 W	48.5 cm	35 × 46 × h66.5	DH.WHM8162	DH.WHM8162.1	



Optional Stainless-steel Rod, Holder & Clamp

- DH.WHP503037 (3) Stand Rod, ϕ 12.7 × L520mm, “RD300”, for Heating Mantles
 DH.WHP503012 (4) Holder / Clamp / Clip, “CL220”, for Temp. Sensor

Ea. Price, ₩

Articles

Cat. No

Description

DAIHAN® Remotelycontrolled Reaction Vessel Heating Mantle, (1)Plain Bottom & (2)Bottom Outlet-type, 450°C, 100ml~100Lit With Nickel Chrome Heating Element, K-type Thermo-Sensor Integrated, with Certi. & Traceability, Option-Controller
 반응조용 히팅맨틀, K-type 온도센서, Ni-Cr열선 내장, 자력교반기와 사용가능, 조절기 별도

- Made in Korea ■ Powder-coated Steel Housing.
- with Certificate & Traceability : Controlled by Serial Number, Certificate, Delivery-information, and Traceable Data Base System
- Optional Remote Thermo Controller, K-type Thermo-Sensor, and Nickel-Chrome Heating Element "Coil-type" : Acid Resistant & Long Life Time.
- Heating Mantles for 50ml~6,000ml Flask are with a Device* for Holding a Optional Stainless-steel Rod ϕ 12.7 mm for Article Support.



(1) Plain Bottom-type
Remotecontrolled Reaction Vessel
Heating Mantle

(1) Plain Bottom-type

Vessels, ml Dia. ϕ × H(cm)	Mantle			Catalog No.		Ea. Price, ₩
	Watts (W)	Inside Depth	Outside ϕ × h(cm)	with 230V	with 120V	
100ml, ϕ 7 × H9	80 W	6.5cm	ϕ 14.5 × h11.0	DH.WHM8170	DH.WHM8170.1	
250ml, ϕ 7 × H13	140 W	10.5cm	ϕ 14.5 × h14.0	DH.WHM8171	DH.WHM8171.1	
500ml, ϕ 11 × H12	240 W	9.0cm	ϕ 19.0 × h13.5	DH.WHM8172	DH.WHM8172.1	
1,000ml, ϕ 11 × H20	350 W	14.0cm	ϕ 19.0 × h16.5	DH.WHM8173	DH.WHM8173.1	
2,000ml, ϕ 13 × H24	450 W	16.5cm	ϕ 19.0 × h19.0	DH.WHM8174	DH.WHM8174.1	
2,000ml, ϕ 14 × H27	550 W	20.5cm	ϕ 20.6 × h22.0	DH.WHM8175	DH.WHM8175.1	
3,000ml, ϕ 13 × H32	550 W	26.5cm	ϕ 19.0 × h29.0	DH.WHM8176	DH.WHM8176.1	
4,000ml, ϕ 20 × H29	800 W	21.0cm	ϕ 27.0 × h22.5	DH.WHM8178	DH.WHM8178.1	
5,000ml, ϕ 20 × H29	800 W	21.0cm	ϕ 27.0 × h22.5	DH.WHM8178	DH.WHM8178.1	
6,000ml, ϕ 21.5 × H32	800 W	24.5cm	ϕ 32.5 × h23.5	DH.WHM8179	DH.WHM8179.1	
10Lit, ϕ 21.5 × H45	1400 W	32.0cm	ϕ 32.5 × h35.0	DH.WHM8180	DH.WHM8180.1	
10Lit, ϕ 24 × H41	1400 W	32.0cm	ϕ 32.5 × h35.0	DH.WHM8181	DH.WHM8181.1	
20Lit, ϕ 25 × H47	2000 W	40.0cm	ϕ 40.0 × h45.0	DH.WHM8182	DH.WHM8182.1	
20Lit, ϕ 27 × H45	2000 W	35.0cm	ϕ 40.0 × h40.0	DH.WHM8183	DH.WHM8183.1	
20Lit, ϕ 29 × H42	2000 W	35.0cm	ϕ 40.0 × h40.0	DH.WHM8184	DH.WHM8184.1	
50Lit, ϕ 31.5 × H81	4000 W	70.0cm	ϕ 44.0 × h75.0	DH.WHM8185	DH.WHM8185.1	
100Lit, ϕ 41.5 × H91	6000 W	75.5cm	ϕ 55.0 × h83.0	DH.WHM8186	DH.WHM8186.1	



(2) Bottom Outlet-type
Remotecontrolled Reaction Vessel
Heating Mantle

(2) Bottom Outlet-type / with Bottom Drain Valve PTFE

* Bottom Outlet Hole Size : L7.2 × W4.0cm(500~2,000ml) or L12.0 × W7.0cm(3,000ml~100Lit)

Vessels, ml Dia. ϕ × H(cm)	Mantle			Catalog No.		Ea. Price, ₩
	Watts (W)	Inside Depth	Outside ϕ × h(cm)	with 230V	with 120V	
500ml, ϕ 11 × H12	240 W	8.5cm	ϕ 19.0 × h11.0	DH.WHM8190	DH.WHM8190.1	
1,000ml, ϕ 11 × H20	350 W	14.0cm	ϕ 19.0 × h16.5	DH.WHM8191	DH.WHM8191.1	
2,000ml, ϕ 13 × H24	450 W	16.5cm	ϕ 19.0 × h19.0	DH.WHM8192	DH.WHM8192.1	
2,000ml, ϕ 14 × H27	550 W	16.5cm	ϕ 20.6 × h22.0	DH.WHM8193	DH.WHM8193.1	
3,000ml, ϕ 13 × H32	550 W	26.5cm	ϕ 19.0 × h29.0	DH.WHM8194	DH.WHM8194.1	
4,000ml, ϕ 20 × H29	800 W	21.0cm	ϕ 27.0 × h22.5	DH.WHM8196	DH.WHM8196.1	
5,000ml, ϕ 20 × H29	800 W	21.0cm	ϕ 27.0 × h22.5	DH.WHM8196	DH.WHM8196.1	
6,000ml, ϕ 21.5 × H32	800 W	24.5cm	ϕ 32.5 × h23.5	DH.WHM8197	DH.WHM8197.1	
10Lit, ϕ 21.5 × H45	1400 W	31.0cm	ϕ 32.5 × h35.0	DH.WHM8198	DH.WHM8198.1	
10Lit, ϕ 24 × H41	1400 W	31.0cm	ϕ 32.5 × h35.0	DH.WHM8199	DH.WHM8199.1	
20Lit, ϕ 25 × H47	2000 W	41.0cm	ϕ 40.0 × h45.0	DH.WHM8200	DH.WHM8200.1	
20Lit, ϕ 27 × H45	2000 W	35.0cm	ϕ 40.0 × h40.0	DH.WHM8201	DH.WHM8201.1	
20Lit, ϕ 29 × H42	2000 W	35.0cm	ϕ 40.0 × h40.0	DH.WHM8202	DH.WHM8202.1	
50Lit, ϕ 31.5 × H81	4000 W	70.0cm	ϕ 44.0 × h75.0	DH.WHM8203	DH.WHM8203.1	
100Lit, ϕ 41.5 × H91	6000 W	78.0cm	ϕ 55.0 × h83.0	DH.WHM8204	DH.WHM8204.1	

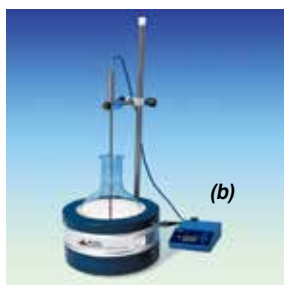

<Ex.>
Heating Mantle Set
with Temp. Probe and
the Digital Feedback Temp.
Controller "WHM - C10D"

Optional Remote Controller

- (a) Analog Remote Controller, 5~100% of Rated Voltage, Up to 1.2kW
 (b) Digital Remote Controller, Ambient +5 ~ 700°C, \pm 1°C Uniformity at Set Temp.

Cat. No		Ea. Price, ₩
with 230V	with 120V	
DH.WHM13500	DH.WHM23500	
DH.WHM12500	DH.WHM22500	

Optional Temp. Probe & Stand Rod, Holder, Clamp for Digital Temp. Remote Controller

- (3) Stand Rod, "RD300", ϕ 12.7 × L520mm
 (4) Holder / Clamp / Clip for Temp. Probe

- DH.WHP503040 Direct Contact Temp. Probe, K-type, "SS300", L250 × ϕ 4.8 mm
 DH.WHP503050 "SS400", L380 × ϕ 4.8 mm
 DH.WHP503041 Direct Contact Temp. Probe, K-type, "SS310", Teflon Coated, L250 × ϕ 5 mm
 DH.WHP503051 Direct Contact Temp. Probe, K-type, "SS410", Teflon Coated, L380 × ϕ 5 mm
 DH.WHP503037 (3) Stand Rod, ϕ 12.7 × L520mm, "RD300", for Heating Mantles
 DH.WHP503012 (4) Holder / Clamp / Clip, "CL220", for Temp. Sensor

Ea. Price, ₩

DAIHAN® Analog Aluminum-case Multi Heating Mantle, with 3 & 6 Places, 450°C, with Certi. & Traceability
 With Glassware Supporting Rod & Clamp, Ideal for Extraction · Reflux · Distillation Applications, Lower Profile, 250~1,000ml
 3 & 6구 멀티 히팅맨틀, 추출/증류용에 적합, 조절기 내장

- Made in Korea
- with Certificate & Traceability : Controlled by Serial Number, Certificate, Delivery-information, and Traceable Data Base System
- Lower Profile for Space-saving Convenience
- Ideal for Repetitive Extraction (Kjeldahl, Soxhlet and other Extraction Procedure), Reflux and Distillation Laboratory Applications
- Analog Controller Built-in System
- Rods and Clamps for Rods Connection
- Ideal for DURAN / Kimax / Pyrex & Iwaki-brand Round Flasks
- Highly-processed Aluminum Case Offers Robust Standing, Easy Handling
- Nickel Chrome Heating Element - Coil Type : Acid-Resistant, Long Life Time
- without Clamp & Clamp Holder for Glassware ; Order Separately



(1) Analog 6 places Heating Mantle (WHM12293)

Premium Analog Multi Heating Mantle

Highly-processed Aluminum Case
 Nickel Chrome Heating Element



(2) Analog 3 places Heating Mantle (WHM12391)

(1) 6 places Analog Multi Heating Mantle, 250ml, 300ml & 500ml, 450°C

Catalog No.		Flask Capacity (ml)	Flask		Watts(W)	Inside Depth (mm)	Dimension W×D×H (mm)	Ea. Price, ₩
with 230V	with 120V		Max. Dia. φ (mm)	Bottom				
DH.WHM12291	DH.WHM12292	250/300	83 ~ 86	Flat	840	50	800×240×110	
DH.WHM12293	DH.WHM12294	250/300	83 ~ 86	Round	840	50	800×240×110	
DH.WHM12295	DH.WHM12296	500	102 ~ 105	Round	1440	65	950×270×130	

(2) 3 places Analog Multi Heating Mantle, 500ml & 1,000ml, 450°C

Catalog No.		Flask Capacity (ml)	Flask		Watts(W)	Inside Depth (mm)	Dimension W×D×H (mm)	Ea. Price, ₩
with 230V	with 120V		Max. Dia. φ (mm)	Bottom				
DH.WHM12391	DH.WHM12392	500	102 ~ 105	Round	720	65	550×270×130	
DH.WHM12393	DH.WHM12394	1,000	130 ~ 133	Round	1050	75	690×340×170	

※ Remarks : DU. : DURAN Ki. : Kimax Iw. : Iwaki Py. : Pyrex

Spare Support Rod & Clamp Set

- DH.WHM30500 Support Rod & Clamp Set, "MHR01", for 3Places 500ml, 2×750-1×500-mm Rod and 2×Clamp for Rod
- DH.WHM31000 , "MHR02", for 3Places 1000ml, 2×750-1×600-mm Rod and 2×Clamp for Rod
- DH.WHM60250 , "MHR03", for 6Places 250-300-ml, 2×750-1×900-mm Rod and 2×Clamp for Rod
- DH.WHM60500 , "MHR04", for 6Places 500ml, 2×750-1×940-mm Rod and 2×Clamp for Rod

Ea. Price, ₩

Articles	Cat. No	Description
----------	---------	-------------

DAIHAN® Heating Tape “WHM”, Standard-type, 250°C, 13 & 25mm



Heating Tape

* For Glass Tubes Metal Pipet

Catalog No.	13mm Width × Length(m)	Watts & Volt	Ea. Price, ₩
DH.WHM12311	13mm × 0.6m	200W, 230V	
DH.WHM12312	× 1.0m	200W, 230V	
DH.WHM12313	× 1.5m	250W, 230V	
DH.WHM12314	× 2.0m	300W, 230V	
DH.WHM12315	× 2.5m	350W, 230V	
DH.WHM12316	× 3.0m	400W, 230V	
Catalog No.	25mm Width × Length(m)	Watts & Volt	Ea. Price, ₩
DH.WHM12321	25mm × 0.6m	200W, 230V	
DH.WHM12322	× 1.0m	200W, 230V	
DH.WHM12323	× 1.5m	250W, 230V	
DH.WHM12324	× 2.0m	300W, 230V	
DH.WHM12325	× 2.5m	350W, 230V	
DH.WHM12326	× 3.0m	400W, 230V	
DH.WHM12327	× 4.0m	550W, 230V	
DH.WHM12328	× 6.0m	700W, 230V	

DAIHAN® Custom-Made Heating Mantle & Insulation, Up to 450°C~650°C

Ideal for Bottom Valved Vessels or General-use, “WHM”, 고객 주문 사양 히팅맨틀 및 단열/보온재

We can Offer DAIHAN Custom Heating Mantle, for which you can Specify the Outside Diameter of the Vessel, Length of Mantle, Voltage, Number of Circuits and Length of Each Heating Zone, Ambient Temperature, Unusual Ambient Conditions, Size & Location of Holes for View Ports, and Tubulations.

Please Submit a Sketch for Complicated Applications and Contact our International Sales Team or our Distributor in your Country.

- Provides Uniform Heating and Insulation for Scrubbing and Fractionating Columns.

- Closes with a Zipper, with Eyelets and laces or Hooks and laces.

- Internal Operating Temperature is up to 450°C or 650°C

Examples for Customized Heating Mantle



Welcome! Custom-Made Heating Mantle!!

DAIHAN® Analog Compact Temp Controller “WHM-C10A”, up to 1.2kW, for All-Purpose Heating Instruments With Solid State, Proportional Voltage Power Control (5~100%), **아날로그 온도 조절기**

■ Made in Korea ■ with Certificate & Traceability : Controlled by Serial Number, Certificate, Delivery-information, and Traceable Data Base System



Analog Compact Temp. Controller “WHM-C10A”



<Ex.>
Heating Mantle Set with the Analog Compact Temp. Controller “WHM-C10A”

- PL (Product Liability) Insurance
- Small Footprint, Compact Analog Temperature Controller
- Precise Manual Control of Heating Mantles, Tapes, Cords and Other Resistive Loads up to 1.2 kW

* Safe and Durable Design
* Solid state, Proportional Voltage Power Control (5~100% or Rated Voltage)

Specifications & Ordering information

Spec.	Model	“WHM-C10A”
Control Range & Capacity		5~100% of Rated Voltage, Up to 1.2 kW
Dimension & Weight		95×98×h106mm, 1 kg
Packing Size & Gross Weight		190×160×h130mm, 2 kg
Electrical Reqts.		1 Phase, AC 120 V, 60 Hz or AC 230 V, 50 / 60 Hz
Cat. No.	230V	DH.WHM13500
	120V	DH.WHM23500
Price, Each. ₩		

* Other Specifications are available upon Customer's Request.

DAIHAN® Digital Feedback Temp Controller “WHM-C10D”, up to 700°C, ±0.1°C, with Back-Light LCD For All-purpose Heating Instruments, Available K-type External Direct Contact Thermocouple(Optional), **디지털 온도 조절기**

■ Made in Korea ■ with Certificate & Traceability : Controlled by Serial Number, Certificate, Delivery-information, and Traceable Data Base System



Digital Feedback Temp. Controller “WHM-C10D”



<Ex.>
Heating Mantle Set with Temp. Probe and the Digital Feedback Temp. Controller “WHM-C10D”

- PL (Product Liability) Insurance
- User's Self-compensation Function to Control Difference between Real Temp. and Indicated Temp. (±50°C)
- Patented Jog-Shuttle Control System

* Digital Feedback Control by High-Performance Microprocessor
* Digital LCD with Back-Light Function * Small Footprint and User-Friendly Design.
* Storage function, Timer, Alarm & Locking Mode
* Heating Instruments can be controlled up to 2kW.
* Accurate Temp. Control of the Liquid in the Vessel using Optional Direct K-type Sensor

Specifications & Ordering information

Spec.	Model	“WHM-C10D”
Temp. Range & Accuracy		Ambient +5 ~ 700°C, ±1°C at Set Temperature
Temp. Resolution		1°C-Display, 1°C-Control
Timer & Alarm		99hr 59min (Continuous run), Error status & Timer-end
Display		Digital LCD with Back Light Function (Temp., Timer)
Controller		Digital Feedback Controller with Jog Shuttle Switch (Turn+Push)
Control Capacity		up to 2 kW for 230V, 1.5kw for 120V
Dimension & Weight		145×185×h68mm, 2.8 kg
Packing Size & Gross Weight		280×250×h110mm, 4 kg
Electrical Reqts.		1 Phase, AC 120 V, 60 Hz or AC 230 V, 50 / 60 Hz
Cat. No.	230V	DH.WHM12500
	120V	DH.WHM22500
Price, Each. ₩		

* Other Specifications are available upon Customer's Request.

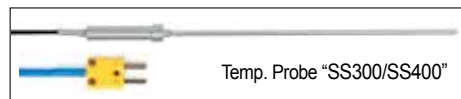

(1) External/Direct Contact Temp. Probe

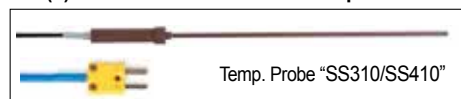

(2) External/Direct Contact Temp. Probe, Teflon Coated

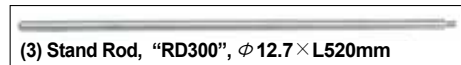

(3) Stand Rod, “RD300”, φ 12.7×L520mm



(4) Holder / Clamp / Clip for Temp. Probe

Optional Temp. Probe & Stand Rod, Holder, Clamp

- DH.WHP503040 (1) Direct Contact Temp. Probe, K-type, “SS300”, L250×φ 4.8 mm
- DH.WHP503050 (1) Direct Contact Temp. Probe, K-type, “SS400”, L380×φ 4.8 mm
- DH.WHP503041 (2) Direct Contact Temp. Probe, K-type, “SS310”, Teflon Coated, L250×φ 5 mm
- DH.WHP503051 (2) Direct Contact Temp. Probe, K-type, “SS410”, Teflon Coated, L380×φ 5 mm
- DH.WHP503037 (3) Stand Rod, φ 12.7×L520mm, “RD300”, for Heating Mantles
- DH.WHP503012 (4) Holder & Clamp, “CL220”, for Temp. Sensor

Ea. Price, ₩

DAIHAN Scientific

Homogenizer

Homogenizer, with Direct Controller	P. 96
, with Remote Digital Controller	P. 97
, Accessory	P. 98
Homogenizing Stirrer for Tissue Grinder	P. 99
Homogenizing Tissue Grinder	P. 99



● **Homogenizer
with Direct Controller**
"HG-15A"
27,000 rpm



● **Digital Homogenizer
with Remote Controller**
"HG-15D"
2,000~27,000 rpm



● **Homogenizing Stirrer
for Tissue Grinder**
"HS-30E"
200~5,000 rpm

DAIHAN® Homogenizer with Direct Controller "HG-15A", up to 27,000 rpm, 1~2,500ml
 With Analog Stepless Control System, High Efficiency Dispersing Tools, High-Speed · High-Quality · Low Noise
 균질기 / 호모게나이저, 아날로그 컨트롤러 내장, 초고속/저소음 모터

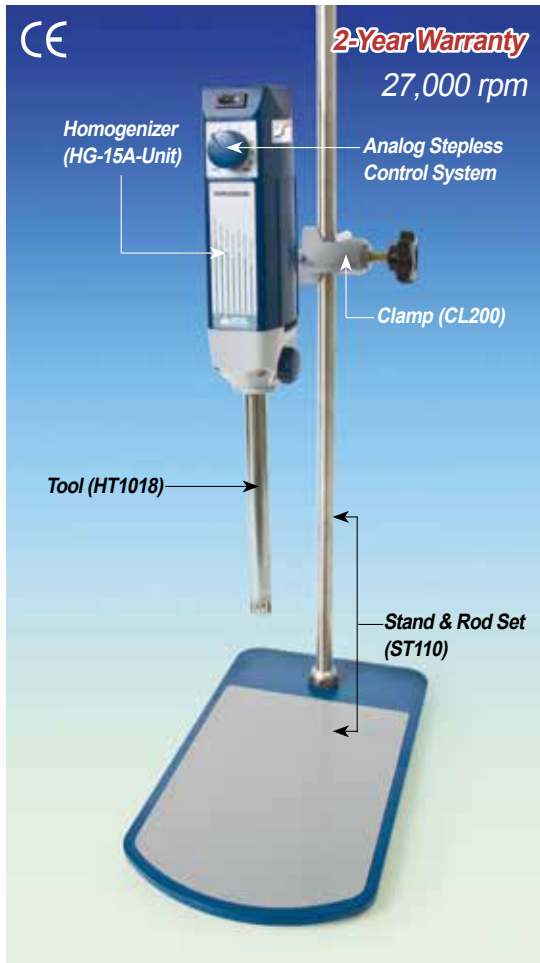

A. Homogenizer Package-set "HG-15A-Set-A"

- Made in Korea ■ CE Certified ■ PL(Product Liability) Insurance
- with Certificate & Traceability : Controlled by Serial Number, Certificate, Delivery-information, and Traceable Data Base System
- Useful for All Dispersing and Homogenizing Applications
- Over Heat Protection
- * Designed for Liquid and Tissue Samples
- * Useful for All Dispersing and Homogenizing Applications
- * High Speed / High Quality / Low Noise : Max. 27,000 RPM (without load)
- * Speed & Power Control Optimized for a Sample
- * High Efficiency Dispersing Tool made of Stainless-steel and PTFE

Specifications & Ordering information

Spec.	Model	A. "HG-15A-Set-A" with HT1018	B. "HG-15A-Set-B" with HT1025	C. "HG-15A" (Unit Only)
Speed Range & Adjustment		Max. 27,000 rpm (without load), Stepless		
Working Range		1 ~ 2,500ml		
Motor Rating (Input / Output)		Input : 300W, Output : 160 W		
Controller		Analog Phase Controller		
Standard Component Acc.		"HT1018" Dispersing Tool, "CL200" Clamp, "ST110" Stand	"HT1025" Dispersing Tool, "CL200" Clamp, "ST110" Stand	Unit Only
Safety Device		Over Heat Protector		
Usable Dispersing Tool		φ 8mm Stator "HT1008", φ 10mm Stator "HT1010", φ 18mm Stator "HT1018", φ 25mm Stator "HT1025"		
Material		Aluminum Die-casting and ABS-Unit, Stainless-steel (# 304)-Tool		
Permissible Temp. & Moisture		Ambient +5 ~ 50 °C, 85%		
Extension Arm Size		φ 12.7 × L250mm		
Dimension & Weight		60 × 75 × h215mm, 2.5kg		
Packing Size & Gross Weight		320 × 300 × h190mm, 5 kg		
Power Consumption		160W		
Electrical Reqt.		1 Phase, AC 120V, 60Hz or AC 230V, 50 / 60Hz		
Cat. No.	230V	DH.WHG02016	DH.WHG02017	DH.WHG02015
	120V	DH.WHG01016	DH.WHG01017	DH.WHG01015
Price, Each. ₩				

* Other Specifications are available upon Customer's Request.

Spare Dispersing Tool & Clamp & Plate Stand

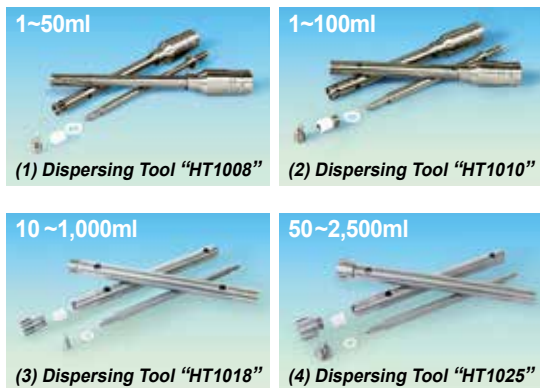

		Ea. Price, ₩
DH.WHG02108	(1) Dispersing Tool, "HT1008", Rotor φ 6, Stator φ 8mm, 1~50ml	
DH.WHG02110	(2) Dispersing Tool, "HT1010", Rotor φ 7.96, Stator φ 10mm, 1~100ml	
DH.WHG02118	(3) Dispersing Tool, "HT1018", Rotor φ 12.8, Stator φ 18mm, 10~1000ml	
DH.WHG02125	(4) Dispersing Tool, "HT1025", Rotor φ 20, Stator φ 25mm, 50~2500ml	
SL.Cla8011	Clamp, "CL200", for Stirrer or Homogenizer, Cast Aluminum, Grip Capacity φ 23mm for Stand/Rod	
DH.WOS501510	Standard Plate Stand, "ST110", for Stirrer or Homogenizer, φ 16 × h800 mm Rod, w20 × d35 cm Plate, with Silicone Pad	
DH.WOS501515	Wide Plate Stand, "ST120", for Stirrer or Homogenizer, φ 23 × h1000 mm Rod, w30 × d40 cm Plate, with Silicone Pad	

※ See page 98 for the Specifications of Dispersing Tools and Accessories.

DAIHAN® Homogenizer with Remote Digital Controller “HG-15D”, 2,000~27,000rpm With Microprocessor Control, High-Efficiency Dispersing Tools, Back Light LCD, 1~2,500ml 디지털 균질기 / 호모게나이저, 분리형 리모트 컨트롤러, 초고속/저소음 모터

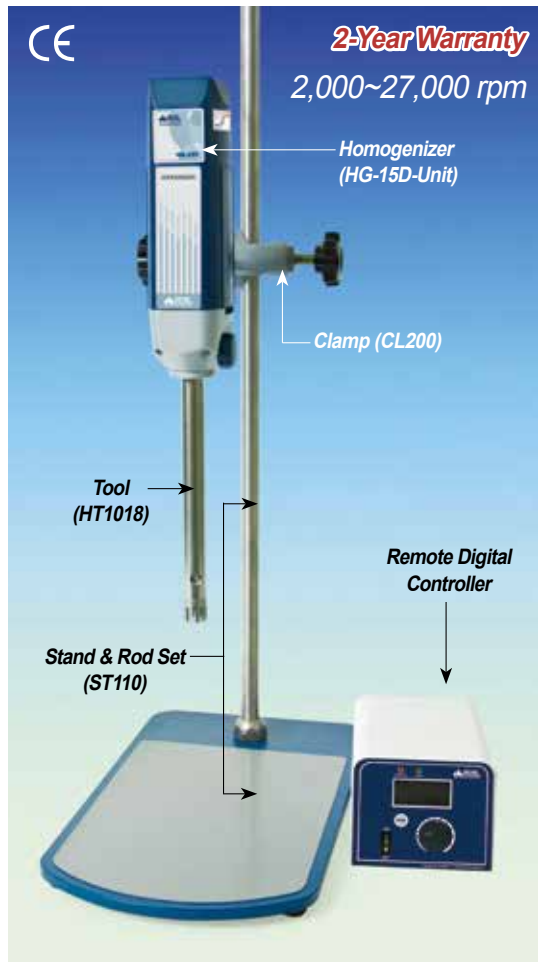

A. Homogenizer with Remote Digital Controller “HG-15D-Set-A”

- Made in Korea ■ CE Certified ■ PL(Product Liability) Insurance
- with Certificate & Traceability : Controlled by Serial Number, Certificate, Delivery-information, and Traceable Data Base System
- Patented Jog-Shuttle Control System

- * Useful for All Dispersing and Homogenizing Applications
- * Designed for Liquid and Tissue Samples
- * High Speed / High Quality / Low Noise : Max. 27,000 RPM (without load)
- * Remote Digital Controller : Fully Digital Controlled by Using Microprocessor
- * Speed & Power Control Optimized for a Sample
- * LCD of Speed(RPM) and Power Bar Graph
- * High Efficiency Dispersing Tool made of Stainless-steel and PTFE

Specifications & Ordering information

Spec.	Model	A. “HG-15D-Set-A” with HT1018	B. “HG-15D-Set-B” with HT1025	C. “HG-15D” (Unit Only)
Speed Range & Resolution		2,000 ~ 27,000rpm (without load), 10 rpm-Control		
Working Range		1 ~ 2,500ml		
Motor Rating (Input / Output)		Input : 300W, Output : 160 W		
Timer & Alarm		10sec ~ 15min, Timer-end Alarm		
Display		Digital LCD with Back-Light Function		
Controller		Digital Feedback Controller (Remote Type)		
Standard Component Acc.		“HT1018” Dispersing Tool, “CL200” Clamp, “ST110” Stand	“HT1025” Dispersing Tool, “CL200” Clamp, “ST110” Stand	Unit Only
Safety Device		Over Load & Over Heat Protector		
Usable Dispersing Tool		φ 8mm Stator “HT1008”, φ 10mm Stator “HT1010”, φ 18mm Stator “HT1018”, φ 25mm Stator “HT1025”		
Material		Aluminum Die-casting and ABS-Unit, Stainless-steel (# 304)-Tool		
Permissible Temp. & Moisture		Ambient +5 ~ 50℃, 85%		
Extension Arm Size		φ 12.7 × L250mm		
Dimension & Weight		60 × 75 × h215mm, 2.5kg		
Packing Size & Gross Weight		580 × 340 × h230mm, 6 kg		
Power Consumption		160W		
Electrical Reqts.		1 Phase, AC 120V, 60Hz or AC 230V, 50 / 60Hz		

Cat. No.	230V	DH.WHG02019	DH.WHG02020	DH.WHG02018
	120V		DH.WHG01019	DH.WHG01020
Price, Each. ₩				

* Other Specifications are available upon Customer’s Request.

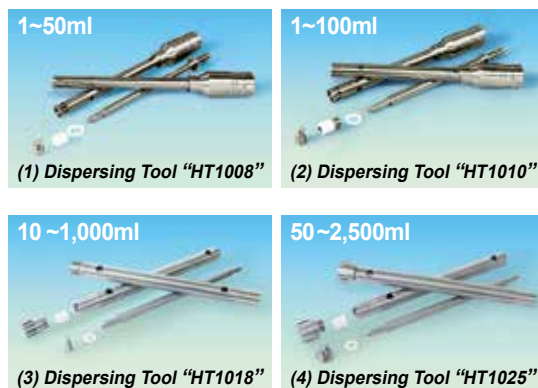

Spare Dispersing Tool & Clamp & Plate Stand

		Ea. Price, ₩
DH.WHG02108	(1) Dispersing Tool, “HT1008”, Rotor φ 6, Stator φ 8mm, 1~50ml	
DH.WHG02110	(2) Dispersing Tool, “HT1010”, Rotor φ 7.96, Stator φ 10mm, 1~100ml	
DH.WHG02118	(3) Dispersing Tool, “HT1018”, Rotor φ 12.8, Stator φ 18mm, 10~1000ml	
DH.WHG02125	(4) Dispersing Tool, “HT1025”, Rotor φ 20, Stator φ 25mm, 50~2500ml	
SL.Cla8011	Clamp, “CL200”, for Stirrer or Homogenizer, Cast Aluminum, Grip Capacity φ 23mm for Stand/Rod	
DH.WOS501510	Standard Plate Stand, “ST110”, for Stirrer or Homogenizer, φ 16 × h800 mm Rod, w20 × d35 cm Plate, with Silicone Pad	
DH.WOS501515	Wide Plate Stand, “ST120”, for Stirrer or Homogenizer, φ 23 × h1000 mm Rod, w30 × d40 cm Plate, with Silicone Pad	

* See page 98 for the Specifications of Dispersing Tools and Accessories.



Homogenizer Accessory, Dispersing Tool & Plate Stand

(1) Dispersing Tool

- Accurate Stator & Rotor made of Stainless-steel
- High Efficiency Dispersing Tool made of Stainless-steel and PTFE
- Low Cost & High Efficiency

Model	① "HT1008"	② "HT1010"	③ "HT1018"	④ "HT1025"
Working Range	1 ~ 50ml	1 ~ 100ml	10 ~ 1,000ml	50 ~ 2,500ml
Stator Diameter	φ 8 mm	φ 10 mm	φ 18 mm	φ 25 mm
Rotor Diameter	φ 6 mm	φ 7.96 mm	φ 12.8mm	φ 20 mm
Gap between Rotor & Stator	0.25 mm	0.2 mm	0.25 mm	0.35 mm
Allowable Max. Speed	27,000 rpm		20,000 rpm	15,000 rpm
Immersion Depth Min.	35 mm		60 mm	
Immersion Depth Max	70 mm		130 mm	
Shaft Length	138 mm		225 mm	
Bearing Material	PTFE			
Suitable for Solvent	Yes			
Max. Temperature	180°C			
Sterilization Method	All Methods			
Suspensions & Emulsions	Suspension : 10 ~ 50 μ m, Emulsion : 1 ~ 10 μ m			

* Test Condition : 1.8 liters of water in the 2 liters capacity beaker.

- DH.WHG02108 ① Dispersing Tool, "HT1008"
 DH.WHG02110 ② , "HT1010"
 DH.WHG02118 ③ , "HT1018"
 DH.WHG02125 ④ , "HT1025"

Ea. Price, ₩

(2) Clamp & Plate Stand

- SL.Cla8011 ⑤ Clamp, "CL200", for Stirrer or Homogenizer, L135mm, Cast Aluminum, Grip Capacity φ23mm for Stand/Rod
 DH.WOS501510 ⑥ Standard Plate Stand, "ST110", for Stirrer or Homogenizer, φ16×h800 mm Rod, w20×d35 cm Plate, with Silicone Pad
 DH.WOS501515 ⑦ Wide Plate Stand, "ST120", for Stirrer or Homogenizer, φ23×h1000 mm Rod, w30×d40 cm Plate, with Silicone Pad

Ea. Price, ₩

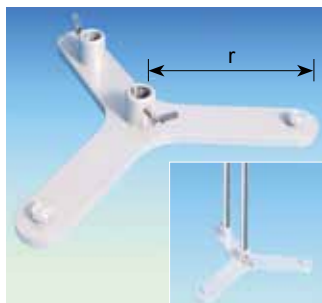

Steel Retort Base Duo Stand, up to φ 16mm Rods, for 2 Rods With Hinged Screw M6, Nonskid Feet equipped, Rod Excluded

* Can Fix Rods up to 2ea (Below φ 16mm) * Stand Thickness : 8mm

Retort Stand, Only Stand Base

* Supplied by Usbeck® in Germany

- US.2040 Stand, "US2040", r = 150mm
 US.2041 , "US2041", r = 185mm

Optional Stainless-steel Rod

- DH.WOS502001 Stainless-steel Rod, "RD501", φ 16×h800mm, Non-screw
 DH.WOS502002 , "RD502", φ 16×h1000mm, Non-screw
 DH.WOS502003 , "RD503", φ 16×h1200mm, Non-screw

Ea. Price, ₩

DAIHAN® High-Quality Stainless-steel (#304) Rod. for Plate Stand, φ 16/23 mm

(1) Plain-type φ 16mm Rod, without Screw

- DH.WOS502001 Stainless-steel Rod, "RD501", φ 16×h800mm, Non-screw
 DH.WOS502002 , "RD502", φ 16×h1000mm, Non-screw
 DH.WOS502003 , "RD503", φ 16×h1200mm, Non-screw
 DH.WOS502031 , "RD531", φ 23×h800mm, Non-screw
 DH.WOS502033 , "RD533", φ 23×h1200mm, Non-screw

Ea. Price, ₩

(2) 1.5P Screw-type φ 16 & 23mm Rod

- DH.WOS502011 Stainless-steel Rod, "RD511", φ 16×h800mm, 1.5P Screw
 DH.WOS502012 , "RD512", φ 16×h1000mm, 1.5P Screw
 DH.WOS502013 , "RD513", φ 16×h1200mm, 1.5P Screw
 DH.WOS502021 , "RD521", φ 23×h800mm, 1.5P Screw
 DH.WOS502022 , "RD522", φ 23×h1000mm, 1.5P Screw
 DH.WOS502023 , "RD523", φ 23×h1200mm, 1.5P Screw

Ea. Price, ₩

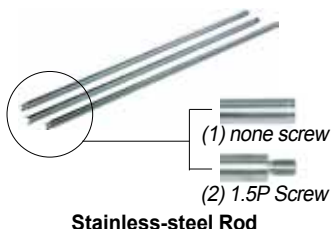

DAIHAN® Homogenizing Stirrer “HS-30E”, for Tissue Grinder, 200~5,000rpm Analog Phase Control, without Tissue Grinder, with Certi. & Traceability, 호모게나이저 스티러



Homogenizing Stirrer Package-Set “HS-30E”

- Made in Korea ■ CE Certified ■ PL(Product Liability) Insurance
- with Certificate & Traceability : Controlled by Serial Number, Certificate, Delivery-information, and Traceable Data Base System
- Ideal for usage with Tissue Grinders
- * Designed for most Laboratory Applications such as Homogenizing or Mixing
- * Compact Unit with Solid State Speed Control

Specifications & Ordering information

Spec.	Model	“HS-30E”
Speed Range & Max. Torque		200 ~ 5,000 rpm, 85 Ncm
Stirring Capacity		Max. 10 Lit
Motor Rating		Input : 83 W, Output : 75 W, 1/10 HP
Safety Device		Over Heat Protector
Controller		Analog Phase Controller
Dimension & Weight		90 × 145 × h180mm, 3.5 kg
Packing Size & Gross Weight		320 × 300 × h190mm, 5 kg
Power Consumption		75W
Electric Reqts.		1 Phase, AC 120V, 60Hz or AC 230V, 50 / 60Hz
Cat. No.	230V	DH.WOS01010
	120V	DH.WOS02010
Price, Each. ₩		
Component of Package-set		included “CL200” Clamp and “ST110” Stand-set(Rod, Plate)
Cat. No.	230V	DH.WOS01011
	120V	DH.WOS02011
Price, Each. ₩		

* Other Specifications are available upon Customer's Request.

※ Note! The Package does not Include a Tissue Grinder

Cowie® Tissue Grinder, with PTFE Pestle Head · Borosilicate Glass Mortar, 2~50ml, Separately Good for Chemical/Heat Resistance, Standard- / Serrated-type PTFE Head Pestles, STS Pestle Rod is Perfect for Motor Drive, 티슈 그라인더



(3) Serrated-type Pestle

■ Supplied by Cowie® in U.K

- * Use for the Controlled Reduction of Particle Size and Homogenisation for a Variety of Substances, especially Biological Material.
- * The pestle head is pure PTFE and pestle rod Stainless-steel, ϕ 6.5mm
- * Pestle Length : 230~270mm * The Mortar is precision borosilicate glass.

(1) Glass Mortar, Borosilicate, 2~50ml

CW.011.102	Mortar, 2ml , ϕ 8 × L120mm
CW.011.105	, 5ml , ϕ 12 × L135mm
CW.011.110	, 10ml, ϕ 15 × L150mm
CW.011.115	, 15ml, ϕ 19 × L155mm
CW.011.130	, 30ml, ϕ 25 × L175mm
CW.011.150	, 50ml, ϕ 32 × L195mm

Ea. Price, ₩

(2) Standard-type Pestle

CW.011.202	Pestle, Standard-type, for 2ml , L230mm
CW.011.205	, for 5ml , L235mm
CW.011.210	, for 10ml, L270mm
CW.011.215	, for 15ml, L270mm
CW.011.230	, for 30ml, L270mm
CW.011.250	, for 50ml, L270mm

Ea. Price, ₩

(3) Serrated-type Pestle

CW.011.302	Pestle, Serrated-type, for 2ml , L230mm
CW.011.305	, for 5ml , L235mm
CW.011.310	, for 10ml, L270mm
CW.011.315	, for 15ml, L270mm
CW.011.330	, for 30ml, L270mm
CW.011.350	, for 50ml, L270mm

Ea. Price, ₩

Hotplate & Hotplate Stirrer

Hotplate, 380°C, Analog & Digital P. 103
 , 500°C, Solid Ceramic Glass Plate P. 101~102
 , 600°C, Hi-Light **New** P. 101
 , Large Plate, 350°C P. 104

Hotplate Stirrer, 380°C, Analog & Digital P. 106
 , 500°C, Solid Ceramic Glass Plate P. 105
 , Systematic Multi-plate, 350°C P. 107



**380°C Digital Precise
Hotplate**
"MSH-20D" Package Set



**600°C Hi-Light
Hotplate**
"HP-D165"



**500°C Hi-temp.
Digital Hotplate Stirrer**
"MaXtir™ MSH500"



350°C Large Plate Digital Hotplate
"HPLP-C-P"

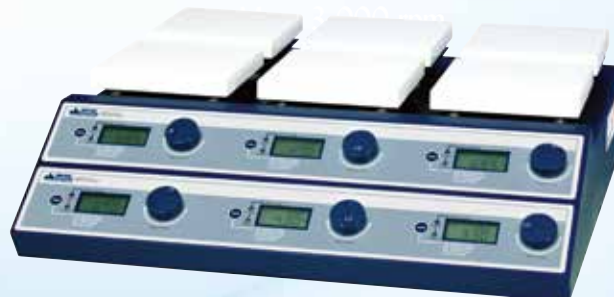

Systematic Multi-Hotplate Stirrer
"SMHS-6"

Wisdom 600°C High-temp Hi-Light Hotplate "HP-D165" & "HP-D200", Digital Control **NEW**
 With Schott NEXTREMA® Ceramic Glass Plate, Hi-Light Heating Element, ϕ 165 & ϕ 200mm, 다용도 고온가열판



High-temp. Hi-Light Hotplate, "HP-D165"

- Made in Korea ■ PL(Product Liability) Insurance
- Patented Jog Dial Control System
- Hi-Light Heating Element & Schott NEXTREMA® Ceramic Glass Plate.
- with Certificate & Traceability : Controlled by Serial Number, Certificate, Delivery-information, and Traceable Data Base System
- * High Temperature Indication LED Lamp for prevention of Burn.
- * Can be used with External Temperature Probe.
 (Please see "Measuring, Thermometer" Section for Optional External Temp Probes)

Specifications & Ordering Information

Spec.	Model	"HP-D165" ϕ 165mm Heating Zone	"HP-D200" ϕ 200mm Heating Zone
Temp. Range & Accuracy		Max. 600°C & \pm 1°C	
Heater & Heating Power		Hi-Light Heating Element 1,100W	Hi-Light Heating Element 1,800W
Plate Size & Heating Zone		220×256 mm, ϕ 165mm	255×300 mm, ϕ 200mm
Controller & Display		Digital PID Controller and LED Display	
Material		Plate : Schott NEXTREMA® Ceramic Glass Plate Housing : PBT	
Dimension(w×d×h) & Weight		231×276×h65mm, 3kg	266×311×h65mm, 4kg
Electrical Reqt.s.		1Phase, AC230V, 50/60Hz	
Cat. No.		DH.HtpD0165	DH.HtpD0200
Price, Each. ₩			

※ NOTE : Design and Specification can be changed when it's released

Maximum Convenience by Advanced Digital Technology

DAIHAN® 500°C High Temp Premium Hotplate, Solid Ceramic Glass Plate



1. High-quality Ceramic Glass Plate

Achieved the maximum temperature of 500°C by using High-quality Ceramic Glass Plate which can resist up to 700°C
 Superior Heat-/Acid-/Chemical-resistant and Easy-to-Clean Plate

2. Hot-top Indicator for User Safety

The Indicator Lamp illuminates while temperature on the Plate Surface is over 50°C regardless power on/off.
 Prevention from a fire or a burn caused by operation at high temperature

3. 2×Independent Internal Temp. Sensor

Two Independent Internal Temp. Sensors: Accurate Temp. Control and Over-temp. Protection.
 1xTemp Control Sensor: Achieved Accurate Temp. Control at High Temp.
 1xOver-Temp. Protection Sensor: Prevention from malfunction or danger caused by Over-temperature.

4. High-quality Insulation (BTU) for User Safety

High-quality Insulation (BTU) ensures User Safety during operation at High Temperature.
 Minimized Heat Transfer from the Plate to the Inside, ensures Long Life-time.

5. External Temp. Sensor

External Temp. Sensor achieves even more Accurate Temp Control by measuring Temp. of Sample. (Optional)

<Continued On Next Page>

DAIHAN® 500°C High-Temp Premium Hotplate “MaXtir™ HP500”, Solid Ceramic Glass Plate, 200×200mm With Large LCD, Optimum Insulation Layer. Accurate Temp Control, Touch-button Controller, Hot-Top Indicator, Max. 500°C, Accu. ±0.3°C 고온용 디지털 가열판, PID 온도 제어, 최적의 방열구조, 내열성/내화학성/내산성 솔리드 세라믹 글라스 플레이트

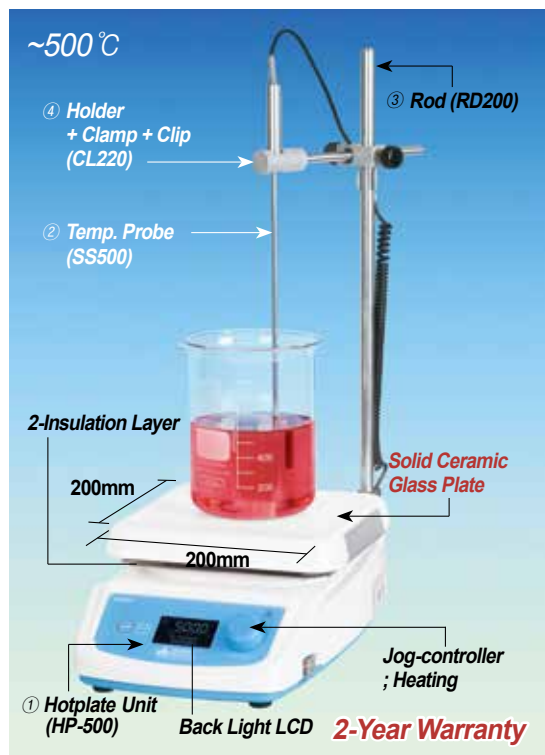

A. “MaXtir™ HP500” Package-set



B. “MaXtir™ HP500” Unit only

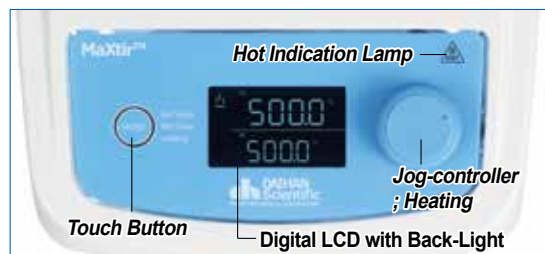

Controller of “MaXtir™ HP500”



- Made in Korea ■ PL (Product Liability) Insurance
 - with Certificate & Traceability : Controlled by Serial Number, Certificate, Delivery-information, and Traceable Data Base System
 - High-quality Solid Ceramic Glass Plate : Heat-/Chemical-/Acid-Resistance and Easy to Clean
 - Optimum Insulation Fourfold Layers : BTU + Ceramic Paper + 2 SUS Insulation Layer
 - Maximum Temperature of 500°C ■ Ergonomic Design
 - Microprocessor PID control
 - Patented Controller “Jog-Dial” and Main Touch Button - Best Durability, Best Mobility, Best Convenient to Operate with Back-Light Function
 - 2 Internal K-type Temp. Sensor Operating Independently : 1 Temp. Control Sensor for Temperature Accuracy and 1 Over Temp. Detection Sensor for User Safety
 - Hot Top Indicator LED Lamp : Hot Surface(Over 50°C) Warning Lamp for User Safety
- * Excellent for Sample Drying and most General Lab Heating Applications
 - * User’s Self -Compensation Function : to Control Difference between Real Temp. and Indicated Temp. (±20.0°C)
 - * Accurate Temp. Control of the Sample in the Vessel using PT100 Sensor (Optional)
 - * Storage Function for the set Values : Temp. and Timer
 - * Minimization of Noise and Improved the Product Life
 - * Use of the Special Advanced Insulation for the safety of the Body Temp.
 - * Locking Mode Supported for Experimental Safety (Input to Jog-Dial can be Disabled)

Specifications & Ordering information

Spec.		Model	A. “MaXtir™ HP500” (Package-set)	B. “MaXtir™ HP500” (Unit Only)
Material	Body Plate		Powder Coated Aluminum Solid Ceramic Glass Plate, 200×200mm	
Stirring Capa.			Max. 20 Lit	
Temp. Range & Accuracy			Max. 500°C, ±0.3°C at Set Temperature	
Temp. Resolution			0.1 °C-Display, 0.5 °C-Control	
Temp. Uniformity			Specially Designed Heating Module : Temp. Difference 10% less	
Heating Power / Consumption			850W	
Timer & Alarm			99hr 59min (with Continuous run.), Error status & Timer-end	
Display			Digital LCD with Back-Light Function	
Controller			Digital Feedback Controller with Jog Dial (Turn+Push) and Touch button.	
Safety Circuit			Over Temp. Protection Hot Top Indicator LED Lamp	
Included Standard Acc.			1ea Stir Bar, ②Temp. Probe ③Rod ④Holder+Clamp	1ea Stir Bar
Permissible Temp. & RH %			Ambient +5 ~ 50°C, 85% RH	
Dimension & Weight			200×332×h114mm, 3.8kg	
Electrical Reqts.			1 Phase, AC 120 V, 60 Hz or AC 230 V, 50 / 60 Hz	
Cat. No.	230V		DH.WHP01500	DH.WHP00500
	120V		DH.WHP01501	DH.WHP00501
Price, Each. ₩				

* Other Specifications are available upon Customer’s Request.

Component of Package-set

- * Package-set : ① Hotplate Unit ② “SS500” PT100 External / Direct Contact Temp. Probe, ③ “RD200” Stainless-steel Support Rod ϕ 12×L450mm ④ “CL220” Holder+Clamp+Clip for External Temp. Probe

Optional External Temp Probe/Stand Rod/Holder/Clamp/Clip

- DH.WHP503060 (1) External / Direct Contact Temp. Probe, “SS500”, Stainless-steel, ϕ 4×L250mm, Cable L190mm
- DH.WHP503061 (2) External / Direct Contact Temp. Probe, “SS510”, Teflon Coated, ϕ 4×L250mm, Cable L190mm
- DH.WHP503036 (3) Stand Rod, “RD200”, Stainless-steel, ϕ 12×L450mm, Screw, for “MaXtir™ HP500”
- DH.WHP503012 (4) Holder/Clamp/Clip, “CL220”, for Temp. Probe

Ea. Price, ₩

DAIHAN® 380°C Standard Analog & Digital Hotplate “HP-A” & “HP-D”, Ceramic-Coated Plate
 With High Temp Uniformity, 180×180- or 260×260-mm Plate, CE Certified, with Certi. & Traceability
 아날로그 & 디지털 정밀 가열판, 우수한 온도균일성 & 경제성, 세라믹 코팅 플레이트

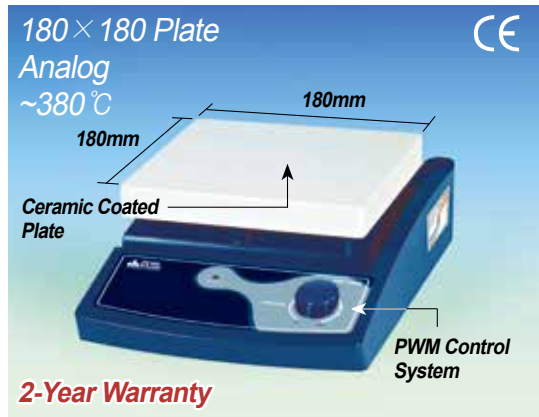

(I-A) Analog “HP-20A”, 180×180mm Plate-type

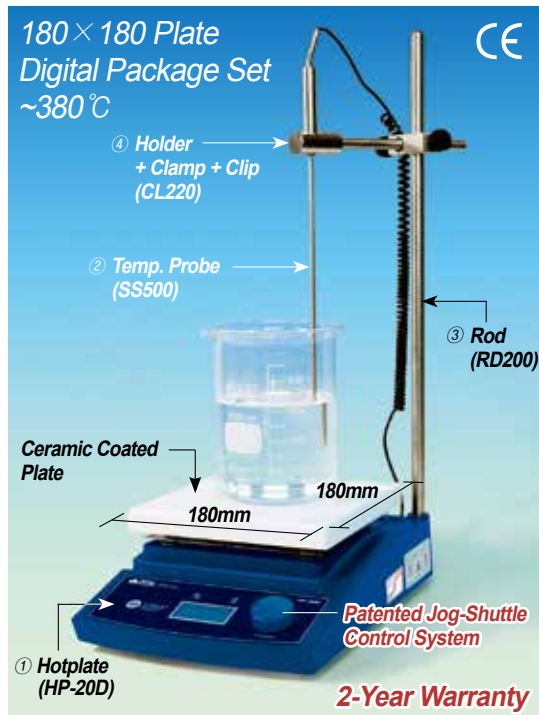

(III-A) Digital “HP-20D” Package-set, 180×180mm Plate-type



(I-B) Analog “HP-30A”, 260×260mm Plate

(II-B) Digital “HP-30D”, 260×260mm Plate



- Made in Korea ■ CE Certified ■ PL (Product Liability) Insurance
- with Certificate & Traceability : Controlled by Serial Number, Certificate, Delivery-information, and Traceable Data Base System

- * Excellent for Sample Drying and most General Lab Heating Applications
- * Superior Temperature Uniformity : Less than 10% on the Plate at Ambient Temperature

I. Analog Control Hotplate “HP-A”

- * Superior Linearity for Temperature Control by Specially Designed Control Circuitry (PWM control)

II. Digital Control Hotplate “HP-D”

■ Patented Jog-Shuttle Control System

- * Digital Feedback Control by High-Performance Microprocessor
- * Digital LCD Display with Back-Light Function, 0.1°C-Display, 0.5°C-Control
- * Temperature Accuracy : ±0.3°C at Set Temp * Safety Circuit : Over Temp Protection
- * Timer : 99hr 59min (with Continuous run), Error status & Timer-end Alarm
- * Locking Mode for Experimental Safety Supported (Input to Jog Shuttle can be disabled)
- * User's Self-Compensation : to Control Difference between Real Temp & Indicated Temp (±20.0°C)

III. Digital Control Hotplate Package-set

- * III-A. “HP-20D” Set : Complete with ① Hotplate “HP-20D”, ② “SS500” PT100 External / Direct Contact Temp. Probe, ③ “RD200” Stainless-steel Support Rod φ12×L450mm, ④ “CL220” Holder+Clamp+Clip for External Temp. Probe
- * III-B. “HP-30D” Set : Complete with ① Hotplate “HP-30D”, ② “SS500” PT100 External / Direct Contact Temp. Probe, ③ “RD100” Stainless-steel Support Rod φ12.7×L390mm, ④ “CL220” Holder+Clamp+Clip for External Temp. Probe

Specifications & Ordering information

Spec.	Model	A. 180×180mm Plate (I-A) Analog “HP-20A” (II-A) Digital “HP-20D”	B. 260×260mm Plate (I-B) Analog “HP-30A” (II-B) Digital “HP-30D”
		Plate Size(mm)	180×180mm Plate-type
Material	Body	Powder Coated Aluminum	Powder Coated steel
	Plate	Ceramic Coated Aluminum (Chemical / Acid Resistance, Easy to Clean)	
Temp. Range & Uniformity	Max. 380°C Temp., High Uniformity : Difference 10% less		
Heating Power/Consumption	600 W	1.2 kW	
Permissible Temp. & RH %	R/T +5 ~ 50°C, 85% RH		
Dimension & Weight	206×307×h99mm, 2.8kg	286×387×h99mm, 3.3kg	
Packing Size & Gross Weight	400×280×h200mm, 5 kg	430×320×200hmm, 5 kg	
Electrical Reqts.	1 Phase, AC 120 V, 60 Hz or AC 230 V, 50 / 60 Hz		

I. Analog Unit Only		(I-A) “HP-20A”	(I-B) “HP-30A”
Cat. No.	230V	DH.WHP03120	DH.WHP03121
	120V	DH.WHP02120	DH.WHP02121
Price, Each. ₩			
II. Digital Unit Only		(II-A) “HP-20D”	(II-B) “HP-30D”
Cat. No.	230V	DH.WHP03020	DH.WHP03022
	120V	DH.WHP02020	DH.WHP02022
Price, Each. ₩			
III. Digital Package-set		(III-A) “HP-20D” Set	(III-B) “HP-30D” Set
Cat. No.	230V	DH.WHP03021	DH.WHP03023
	120V	DH.WHP02021	DH.WHP02023
Price, Each. ₩			

* Other Specifications are available upon Customer's Request.

Optional External Temp Probe/Stand Rod/Holder/Clamp/Clip

- DH.WHP503060 (1) Temp. Probe, “SS500”, “PT100”, φ4×L250mm
- DH.WHP503061 (2) Teflon Coated Temp. Probe, “SS510”, φ4×L250mm
- DH.WHP503011 Stand Rod, “RD100”, φ12.7×L390 for “HP-30A / 30D”
- DH.WHP503036 , “RD200”, φ12×L450 for “HP-20A / 20D”
- DH.WHP503012 Holder / Clamp / Clip, “CL220”, for Temp. Probe

Ea. Price, ₩

DAIHAN® 350°C Large Plate Digital Hotplate “HPLP”, 310×620mm Ceramic-Coated Plate, Superior Temp Uniformity
 Built-in Digital PID Controller or Digital Remote Controller, Back Light LCD, Certificate & Traceability
 디지털 대형 정밀 가열판, 디지털 피드백 온도 제어, 디지털 PID 조절기 / 디지털 원격 조절기, 백색 세라믹 코팅판

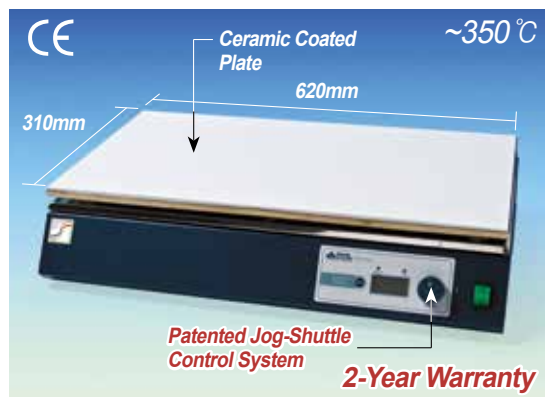

- Made in Korea
- CE Certified
- PL(Product Liability) Insurance
- 2-Years Warranty
- Max Temp : 350°C
- with Certificate & Traceability : Controlled by Serial Number, Certificate, Delivery-information, and Traceable Data Base System
- Superior Temperature Uniformity : Less than 10% on the Plate at Ambient Temperature
- Digital PID Controller
- Patented Jog-Shuttle Control System and Back-Light LCD
- * Excellent for Sample Drying and most General lab Heating Applications
- * Large Heating Area : Ideal for TLC Plate Heating and Surface Heating in Electronic Industries
- * Superior Temperature Uniformity : Less than 10% on the Plate at Ambient Temperature
- * Ceramic Coated Plate -Chemical / Acid Prevention

A. Large Digital Hotplate, with Built-in Digital PID Controller, Ceramic-Coated Plate-type “HPLP-C-P”

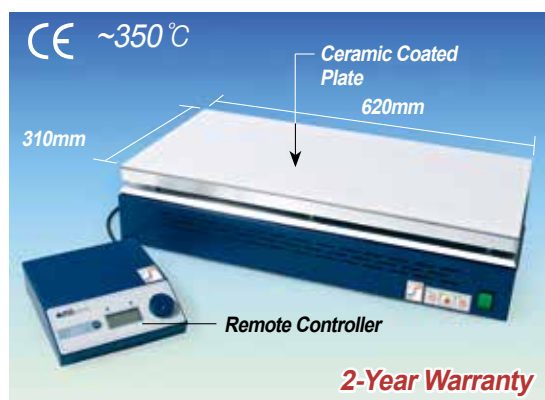

B. Large Digital Hotplate, Digital Remote Controller, Ceramic-Coated Plate-type “HPLP-C-R”

Specifications & Ordering information

Spec.	Models	A. “HPLP-C-P” Built-in Controller	B. “HPLP-C-R” Remote Controller
Controller		Built-in Digital PID Controller	Digital Remote Controller
Plate Surface		Ceramic-coated	
Plate Size		310×620mm	
Temp. Range & Accuracy		Max. 350°C, ±0.3°C at Set Temperature	
Temp. Resolution		0.1 °C-Display, 0.5 °C-Control	
Temp. Uniformity		Specially Designed Heating Module : Temp. Difference 10% less	
Heating Power/Consumption		2 kW	
Timer & Alarm		99hr 59min (with Continuous run.), Error status & Timer-end	
Display		Digital LCD with Back-Light Function	
Permissible Temp. & RH %		Ambient +5 ~ 50°C, 85% RH	
Dimension & Weight		670×360×h150mm, 16kg	
Packing Size & Gross Weight		750×430×h220mm, 18 kg	
Electrical Reqts.		1 Phase, AC 120 V, 60 Hz or AC 230 V, 50 / 60 Hz	
Cat. No.	230V	DH.WHP03024	DH.WHP03025
	120V	DH.WHP02024	DH.WHP02025
Price, Each. ₩			

* Other Specifications are available upon Customer's Request.

DAIHAN® 500°C High-Temp Premium Hotplate Stirrer “MaXtir™ MSH500”, Solid Ceramic Glass Plate, 200×200mm With Large LCD, Optimum Insulation Layer. Accurate Temp Control, Touch-button Controller, Hot-Top Indicator, 80~1,500rpm 고온용 디지털 가열 자력 교반기, 최적의 방열구조, 디지털 피드백 온도 제어, 내열성/내화학성/내산성 슬리드 세라믹 글라스 플레이트

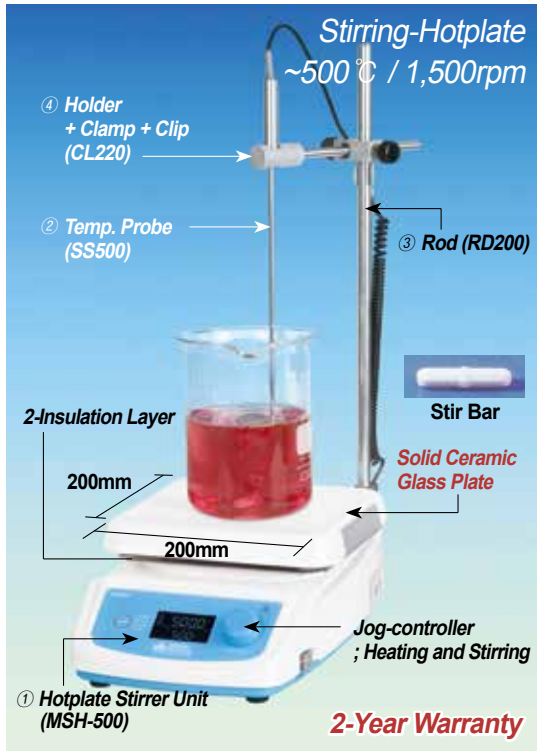

A. “MaXtir™ MSH500” Package-set



B. “MaXtir™ MSH500” Unit only

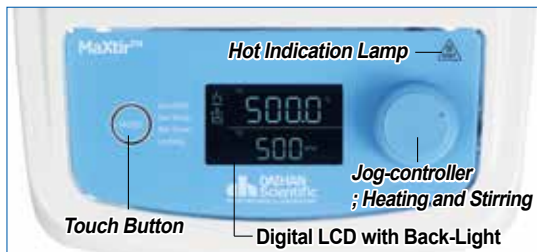

Controller of “MaXtir™ MSH500” model



- Made in Korea ■ PL(Product Liability) Insurance ■ Ergonomic Design
- with Certificate & Traceability : Controlled by Serial Number, Certificate, Delivery-information, and Traceable Data Base System
- High-quality Solid Ceramic Glass Plate : Heat-/Chemical-/Acid-Resistance and Easy to Clean
- Optimum Insulation Fourfold Layer : BTU + Ceramic Paper + 2 SUS Insulation Layer
- Brushless Shade Motor & Powerful Magnet ensures Powerful Stirring and Precise Speed Control, Minimization Noise
- Maximum Temperature of 500°C ■ Microprocessor PID control
- Patented Controller “Jog-Dial” and Main Touch Button - Best Durability, Best Mobility, Best Convenient to Operate with Back-Light Function
- 2 Internal K-type Temp. Sensor Operating Independently : 1 Temp. Control Sensor for Temperature Accuracy and 1 Over Temp. Detection Sensor for User Safety
- Hot Top Indicator LED Lamp : Hot Surface(Over 50°C) Warning Lamp for User Safety
- * Excellent for Sample Drying and most General Lab Heating Applications
- * User's Self-Compensation Function : to Control Difference between Real Temp. and Indicated Temp. (±20.0°C)
- * Accurate Temp. Control of the Sample in the Vessel using PT100 Sensor (Optional)
- * Storage Function for the set Values : Temp. and Timer
- * Minimization of Noise and Improved the Product Life
- * Use of the Special Advanced Insulation for the safety of the Body Temp.
- * Locking Mode Supported for Experimental Safety (Input to Jog-Dial can be Disabled)

Specifications & Ordering information

Spec.		Model	A. “MaXtir™ MSH500” (Package-set)	B. “MaXtir™ MSH500” (Unit Only)
Material	Body	Powder Coated Aluminum		
	Plate	Solid Ceramic Glass Plate, 200×200mm		
Stirring Capa.		Max. 20 Lit		
Speed & Control Resolution		80 ~ 1,500 rpm, 5 rpm		
Temp. Range & Accuracy		Max. 500°C, ±0.3°C at Set Temperature		
Temp. Resolution		0.1°C-Display, 0.5°C-Control		
Temp. Uniformity		Specially Designed Heating Module : Temp. Difference 10% less		
Heating Power / Consumption		850W		
Timer & Alarm		99hr 59min (with Continuous run.), Error status & Timer-end		
Display		Digital LCD with Back-Light Function		
Controller		Digital Feedback Controller with Jog Dial (Turn+Push) and Touch button.		
Stirring Bar		3cm bar-included, Usable : up to 5cm bar		
Safety Circuit		Over Temp. Protection, Hot Top Indicator LED Lamp		
Included Standard Acc.		1ea Stir Bar, ②Temp. Probe ③Rod ④Holder+Clamp	1ea Stir Bar	
Permissible Temp. & RH %		Ambient +5 ~ 50°C, 85% RH		
Dimension & Weight		200×332×h114mm, 3.8kg		
Electrical Reqts.		1 Phase, AC 120 V, 60 Hz or AC 230 V, 50 / 60 Hz, with Cord/Plug		
Cat. No.	230V	DH.WMH00500	DH.WMH01500	
	120V	DH.WMH00501	DH.WMH01501	
Price, Each. ₩				

* Other Specifications are available upon Customer's Request.

Component of Package-set

- * Package-set : ① Hotplate Stirrer Unit ② “SS500” PT100 External / Direct Contact Temp. Probe, ③ “RD200” Stainless-steel Support Rod $\phi 12 \times L450$ mm ④ “CL220” Holder+Clamp+Clip for External Temp. Probe

Optional External Temp Probe/Stand Rod/Holder/Clamp/Clip

	Ea. Price, ₩
DH.WHP503060 (1) External / Direct Contact Temp. Probe, “SS500”, Stainless-steel, $\phi 4 \times L250$ mm, Cable L190mm	
DH.WHP503061 (2) External / Direct Contact Temp. Probe, “SS510”, Teflon Coated, $\phi 4 \times L250$ mm, Cable L190mm,	
DH.WHP503036 (3) Stand Rod “RD200”, Stainless-steel, $\phi 12 \times L450$ mm, 1.5p screw, for “MaXtir™ MSH500”	
DH.WHP503012 (4) Holder/Clamp/Clip, “CL220”, for Temp. Probe	

DAIHAN® 380°C Standard Analog & Digital Hotplate Stirrer “MSH-A” & “MSH-D”, Ceramic-Coated Plate, 80~1,500 rpm 180×180mm or 260×260mm Plate, with Accurate Temp Control, Superior Temp. Uniformity, with Certi. & Traceability
 아날로그 & 디지털 가열 자력 교반기, 우수한 온도제어/온도균일성, 세라믹 코팅 플레이트



(I-A) Analog “MSH-20A”, 180×180mm Plate-type

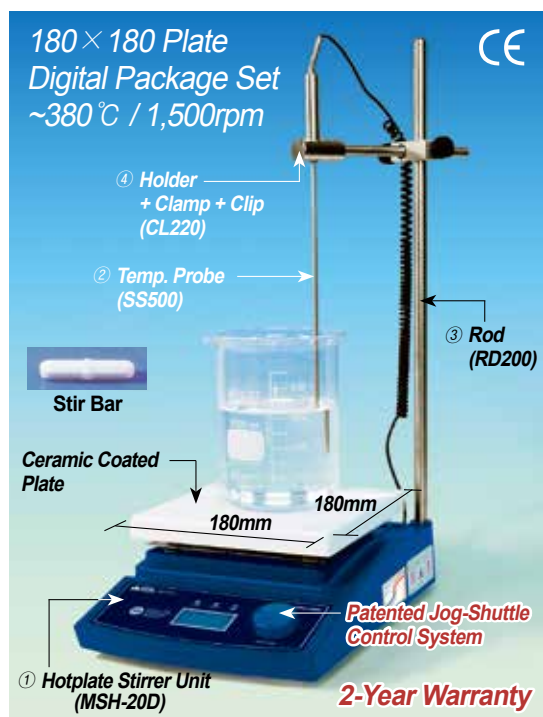

(III-A) Digital “MSH-20D” Package-set, 180×180mm Plate-type



(I-B) Analog “MSH-30A”, 260×260mm Plate

(II-B) Digital “MSH-30D”, 260×260mm Plate

- Made in Korea
- CE Certified
- PL (Product Liability) Insurance
- with Certificate & Traceability : Controlled by Serial Number, Certificate, Delivery-information, and Traceable Data Base System
- Excellent for Sample Drying and most General Lab Heating Applications

I. Analog PWM Control System “MSH-A”

* Superior Linearity PWM Control for Temperature & Stirring Speed

II. Digital Microprocessor Control System “MSH-D”

■ Patented Jog-Shuttle Control System

- * Speed & Control Resolution : 80 ~ 1,500 rpm, 5 rpm
- * Temp. Accuracy / Resolution : ±0.3°C at Set Temp. / 0.1°C-Display, 0.5°C-Control
- * Timer & Alarm : 99hr 59min(with Continuous run), Error status & Timer-end
- * Safety Circuit : Over Temp. Protection
- * User's Self-Compensation : Control Difference between Real Temp. & Indicated Temp. (±20.0°C)
- * Accurate Temp. Control of the Sample in the Vessel using PT100 Sensor
- * Storage Function for the set Values : Temp. and Timer
- * Locking Mode Supported for Experimental Safety (Input to Jog-Shuttle can be Disabled)

III. Digital Package-set ; Complete with

- * III-A. “MSH-20D” Set : ① Hotplate Stirrer “MSH-20D”, ② “SS500” PT100 External / Direct Contact Temp. Probe, ③ “RD200” Stainless-steel Support Rod $\phi 12 \times L450$ mm, ④ “CL220” Holder+Clamp+Clip for External Temp. Probe
- * III-B. “MSH-30D” Set : ① Hotplate Stirrer “MSH-30D”, ② “SS500” PT100 External / Direct Contact Temp. Probe, ③ “RD100” Stainless-steel Support Rod $\phi 12.7 \times L390$ mm, ④ “CL220” Holder+Clamp+Clip for External Temp. Probe

Specifications & Ordering information

Spec.	Model	A. 180×180mm Plate (I-A) Analog “MSH-20A” (II-A) Digital “MSH-20D”	B. 260×260mm Plate (I-B) Analog “MSH-30A” (II-B) Digital “MSH-30D”
		Plate Size(mm)	180×180mm Plate-type
Material	Body	Powder Coated Aluminum	Powder Coated steel
	Plate	Ceramic Coated Aluminum (Chemical / Acid Resistance, Easy to Clean)	
Stirring Capa. & Motor Rating	Max. 20Lit, 9 / 4W		
Temp. Uniformity	Specially Designed Heating Module : Temp. Difference 10% less		
Heating Power/Consumption	600W	1.2kW	
Stirring Bar	3cm bar-included, Usable : up to 5cm bar		
Permissible Temp. & RH %	Ambient +5 ~ 50°C, 85% RH		
Dimension & Weight	206×307×h99mm, 3.3kg	286×387×h99mm, 3.5kg	
Packing Size & Gross Weight	400×280×h200mm, 5kg	430×320×h200mm, 5kg	
Electrical Reqts.	1 Phase, AC 120V, 60Hz or AC 230V, 50 / 60Hz		

I. Analog Unit Only		(I-A) “MSH-20A”	(I-B) “MSH-30A”
Cat. No.	230V	DH.WMH03120	DH.WMH03121
	120V	DH.WMH02120	DH.WMH02121
Price, Each. ₩			
II. Digital Unit Only		(II-A) “MSH-20D”	(II-B) “MSH-30D”
Cat. No.	230V	DH.WMH03020	DH.WMH03022
	120V	DH.WMH02020	DH.WMH02022
Price, Each. ₩			
III. Digital Package-set		(III-A) “MSH-20D” Set	(III-B) “MSH-30D” Set
Cat. No.	230V	DH.WMH03021	DH.WMH03023
	120V	DH.WMH02021	DH.WMH02023
Price, Each. ₩			

* Other Specifications are available upon Customer's Request.

Optional External Temp Probe/Stand Rod/Holder/Clamp/Clip

- DH.WHP503060 (1) Temp. Probe, “SS500”, “PT100”, $\phi 4 \times L250$ mm
- DH.WHP503061 (2) Teflon Coated Temp. Probe, “SS510”, $\phi 4 \times L250$ mm
- DH.WHP503011 Stand Rod, “RD100”, $\phi 12.7 \times L390$ for “MSH-30A / 30D”
- DH.WHP503036 “RD200”, $\phi 12 \times L450$ for “MSH-20A / 20D”
- DH.WHP503012 Holder / Clamp / Clip, “CL220”, for Temp. Probe

Ea. Price, ₩



DAIHAN® 350°C Systematic Multi-Hotplate Stirrer “SMHS”, 3- or 6-Places, Ceramic-Coated Plate
 With Digital Feedback Control, Independent Heating & Stirring Control, up to 350°C, 80~1,500 rpm
 멀티 가열 자력 교반기, 우수한 온도균일성, 3- or 6- 구 개별 조절 가능

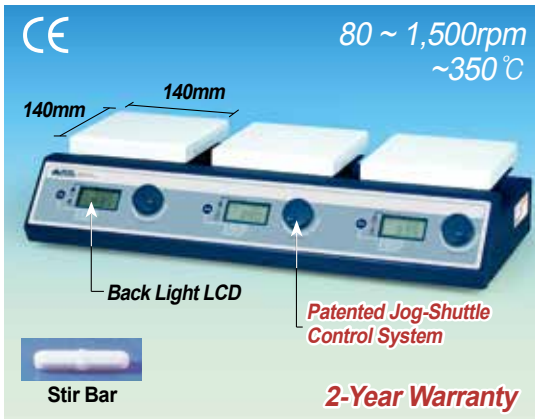

A. 3 Plate-type Multi-Hotplate Stirrer “SMHS-3”

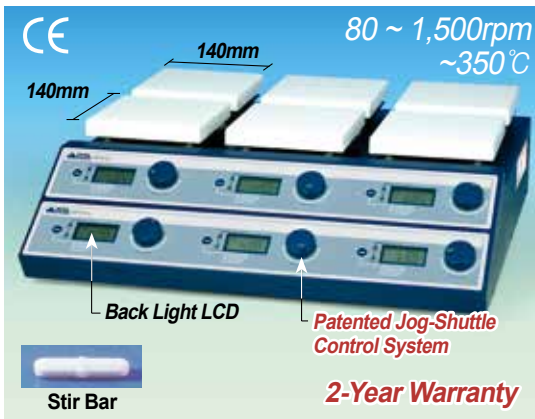

B. 6(3×2) Plate-type Multi-Hotplate Stirrer “SMHS-6”

- Made in Korea
- CE Certified
- PL(Product Liability) Insurance
- with Certificate & Traceability : Controlled by Serial Number, Certificate, Delivery-information, and Traceable Data Base System
- Excellent for Multi-use and wide range Sample Testing
- Patented Jog-Shuttle Control System
- * Systemized 3- and 6-Hotplate Stirrer
- * Independent Heating and Stirring Control
- * Digital Feedback Control by High-Performance Microprocessor
- * Ceramic Coated Plate-Chemical/Acid Resistance
- * Maximum Temperature of 350°C with ±0.3°C Control Accuracy
- * Accurate Temp. Control of the Sample in the Vessel using PT100 Sensor (Optional)
- * Digital LCD with Back-Light Function
- * Digital Timer Function Included : 99 hr 59 min
- * Storage Function for the Set Values : Temperature, RPM and Timer
- * Locking Mode for Experimental Safety Supported

Specifications & Ordering information

Spec.	Model	A. “SMHS-3” 3 Plates	B. “SMHS-6” 6 Plates
Plate-type		3 Plate-type	6(3×2) Plate-type
Plate Size		140×140mm	
Stirring Capa. & Motor Rating		Max. 20 Lit(H ₂ O), 9/4W×3	Max. 20 Lit(H ₂ O), 9/4W×6
Speed & Control Resolution		80 ~ 1,500 rpm, 5 rpm	
Temp. Range & Accuracy		Max. 350 °C, ±0.3°C at Set Temp.	
Temp. Resolution		0.1 °C-Display, 0.5 °C-Control	
Temp. Uniformity		Specially Designed Heating Module : Temp. Difference 10% less	
Heating Power/Consumption		400 W × 3 Plates	400 W × 6 Plates
Timer & Alarm		99hr 59min (with Continuous run.), Error status & Timer-end	
Display		Digital LCD with Back-Light Function	
Controller		Digital Feedback Controller with Jog Shuttle Switch (Turn+Push)	
Stirring Bar		3cm bar-included, Usable : up to 5cm bar	
Ports for Stand Rod		2ea	4ea
Permissible Temp. & RH %		Room Temp. +5 ~ 50°C, 85% RH	
Material	Body	Powder Coated steel	
	Plate	Ceramic Coated Aluminum	
Dimension & Weight		510×240×h100mm, 10kg	510×410×h180mm, 18kg
Packing Size & Gross Weight		540×330×h170mm, 10kg	570×540×h230mm, 18kg
Electrical Reqts.		1 Phase, AC 120 V, 60 Hz or AC 230 V, 50 / 60 Hz	

Cat. No.	230V	DH.WMH03503	DH.WMH03506
	120V		DH.WMH02503
Price, Each. ₩			

* Other Specifications are available upon Customer's Request. ※ 운임 약 ₩ 9,000 별도!

Optional External Temp Probe/Stand Rod/Holder/Clamp/Clip

- DH.WHP503060 (1) External / Direct Contact Temp. Probe, “SS500”, Stainless-steel, φ4×L250mm, Cable L190mm
- DH.WHP503061 (2) External / Direct Contact Temp. Probe, “SS510”, Teflon Coated, φ4×L250mm, Cable L190mm,
- DH.WHP503036 (3) Stand Rod “RD200”, Stainless-steel, 1.5p screw, φ12×L450mm, for “SMHS”
- DH.WHP503012 (4) Holder/Clamp/Clip, “CL220”, for Temp. Probe

Ea.	Price, ₩

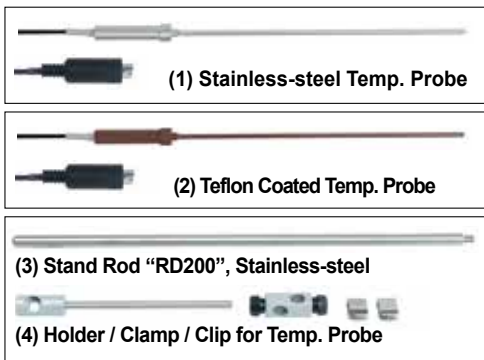



Ice Maker Snow-type "IMS"



Ice Maker Flake-type "IMF"



Granular Ice Maker "F125C"

DAIHAN® 50 & 80kg Automatic Ice Maker, Snow-type "IMS" & Flake-type "IMF" **NEW**
With Fully Automatic System, Uniform Ice, Production & Storage, 아이스메이커

- Made in Korea
 - No Separate Storage Bin Required.
 - Snow Type : Soft Particles in the Form of Rolling Carve
 - Flake Type : A Uniform, Rigid Ice Particle in the Form of Screw Turbine
 - PL(Product Liability) Insurance
 - Full Automatic System : Continuous Ice Production
- * Ice Production and Storage Function at the Same Time
 * Useful in Medical Labs, Pharmaceutical Industry, Scientific Labs, Restaurants and Super markets in General.
 * Creates Uniform Ice with Minimal Water. * R404 Refrigerant and Ozone Friendly
 * Safety Water Level Sensor & Ice Level Sensor
 * Consists of Main Unit, Supply Hose, Drain Hose, Scoop, Power Cable, Operation Manual
 * Optional Water Pump

Specifications & Ordering information

Spec.	Model	"IMS50"	"IMF80"
Ice Type		Snow-type	Flake-type
Production / Day		50 kg	80 kg
Storage Capacity		25 Lit	58 Lit
Compressor		1 / 3HP, R404A	
Door		Front PC Door	
Safety Circuit		Power Circuit Breaker, Ice Level Sensor, Water Level Sensor	
Dimensions (w×d×h)		360×475×620 mm	600×560×740 mm
Weight		40 kg	61 kg
Power Consumption		650 W	800 W
Electric Reqts.		230 V, 50 or 60 Hz	
Cat. No.	60Hz	DH.Ims8050	DH.Imf8080
	50Hz	DH.Ims8055	DH.Imf8085
Price, Each. ₩			

* Other Specifications are available upon Customer's Request.

※ 운임 별도!

Optional Accessory

DH.ImPu1001 Water Pump for "IMS" & "IMF"

Ea. Price, ₩

Icematic® 120kg Automatic Ice Maker, Granular Flake-type "F125C"
With Trouble Free Paddle System, Energy Saving and Maximum Cooling Capacity, 아이스메이커

- Made in Italy
- No Separate Storage Bin Required.
- CE, GS and DVE Certification
- Granular Ice Flakes with High Water Content.
- * Useful in Medical Labs, Pharmaceutical Industry, Scientific Labs, Restaurants and Super markets in General.
- * The Innovative, Trouble Free Icematic Paddle System ensures Perfect Ice Every Time.
- * Flake Ice is Generated through a Vertical Cylinder.
- * The System Creates Uniform Ice with Minimal Water.
- * R134 Refrigerant and Ozone Friendly
- * 5 LED Indicators – Power, Full Bin Situation, Low Temperature, Screw Operation, Shortage of Water.
- * Consist of Main Unit, Water Filter & Housing Set, Ice Sampling Tool, Operation Manual.

Specifications & Ordering information

Spec.	Model	"F125C"
Ice Type		Granular Iceflake
Storage Capacity		27 kg
Daily Ice Production		120 kg / 24 h
Water Inlet Connection		3/4" GAS (Water Supply / Drain Tube : ID ϕ20 mm Flexible Hose)
Dimensions and Weight		w680×d510×h1000mm / 64 kg
Single Phase Input		230 V, 60 Hz or 230 V, 50 Hz
Absorbed Power		490 W
Cat. No.	60Hz	IM.F125C
	50Hz	IM.F126C
Price, Each. ₩		

※ 운임 별도!

DAIHAN Scientific

Incubator

CO₂ <i>New</i>	P. 110~111
General Low Temp-Mini <i>New</i>	P. 112
General Purpose, Forced-air	P. 113~117
, Gravity-air	P. 118~121
, Multi-room, Forced-air	P. 122
Heating Block/Dry Bath Incubator	P. 123~125
Humidity/Temp Test Chamber	P. 126~128
Low Temp(B.O.D)	P. 129~131
Plant Growth Chamber	P. 132~133
Shaking, Bench Top-type	P. 136
, Front Door-type	P. 137
, Mini, CO ₂ & Low Temp <i>New</i>	P. 134~135
, Multi-stack Refrigerated	P. 139
, Top Door-type	P. 138

NEW



General Low Temp-Mini
"ThermoStable™ IC-20"

NEW



CO₂ Incubator
"ICA"

Smart-Lab™
Class-I Medical Device



General Gravity-air
"ThermoStable™ SIG-105"



Multi-room Incubator
"WIM-4"



Class-I Medical Device

Low Temp(B.O.D) Incubator
"ThermoStable™ IR-250"



Shaking Incubator
"ThermoStable™ IS-30"



WiRe™ App Service

Controlled by Smart-Phone

DAIHAN® Air-jacketed CO₂ Incubator "ICA", 101 · 150 Lit, 0~20% CO₂, Up to 60 °C, ±0.1 °C **NEW**
 With Precision CO₂ Sensor, UV Lamp 254nm, Microprocessor PID Control, Fan Forced-Convection, 2 Shelf Included, CO₂ 인큐베이터



Up to 60 °C

Air-jacketed CO₂ Incubator "ICA"



Tempered Safety Inner Glass Door & Enhanced Door Packing

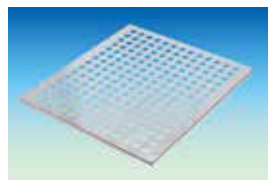

(1) Perforated STS Shelf (Included)



(2) UV Lamp



(3) Regulator, Single-stage

- Made in Korea ■ 2-Year Warranty
- Precise CO₂ Sensor in Stable & Durable Housing, CO₂ Range 0~20%
 - Dual Wavelength Detection, NDIR(Non Dispersive Infra-red) Sensor
 - Automatic Temperature Compensation and Auto Zero Calibration.

- * Ideal for Medicine, Biochemistry and Agricultural Science Research, Industrial Production Departments of Biological Cells, Tissues, Bacterial Culture, etc.
- * All Seamless Stainless-steel Interior for Corrosion Resistance and Decontamination
- * Tempered Safety Inner Glass Door for easy Sample View without Door Opening
- * Enhanced Door Packing to Keep Excellent Temp. & CO₂ Uniformity
- * Air Filtration System(0.3µm HEPA Filter) Minimizes Contamination, Efficiency up to 99.97%.
- * Microprocessor PID Control : Temp(~60°C), Timer, Alarm, Auto-tuning
- * High-Quality LCD Display with Back-Light Function
- * 10 Steps Programmable : Temperature Control and 999 Cycle 10 Steps.
- * Detachable Shelf Frame : Adjustable Shelf
- * Including Water Container, and 2 Stainless-steel Perforated Shelf

Specifications & Ordering information

Spec.	Model	"ICA-100" Max. Capa. 101Lit	"ICA-150" Max. Capa. 150Lit
Capacity		101 Lit	150 Lit
Heating Mechanism		Air-jacket	
CO ₂ Sensor		Digital Signal Processing NDIR Sensor	
Temp Range & Accuracy		Room Temp + 5°C ~ 60°C, Accuracy ± 0.1°C at 20 ~ 25°C	
CO ₂ Range & Accuracy		0 ~ 20% CO ₂ Concentration, Accuracy ± 0.1% at 5%	
Heat up Time (to 37°C)		30 min to 37°C	
CO ₂ Concentration Time (to 37°C)		25 min to 5%	
Heating Power		300 W	570 W
CO ₂ Outlet		1 kg/cm ³	
UV Lamp		254 nm × 1ea	
Controller		Programmable Microprocessor Digital PID Controller with LCD Back Light	
Shelf (Included)		2 Stainless-steel Perforated Shelf	
Circulation		Circulation Fan with HEPA Filter(0.3µm)	
Safety		Temp & CO ₂ Alarm, Over Temp Protector, Sensor Error Display, Leakage Breaker	
Material		Interior : Stainless-steel Polished, Exterior : Stainless-steel Hair Lined	
Door		Interior : Tempered Safety Glass Door, Exterior : Magnetic Packing Door	
Dimension (w×d×h) & Weight	Interior	450 × 450 × h500 mm	495 × 515 × h600 mm
	Exterior	600 × 600 × h600 mm, 65 kg	660 × 645 × h1010 mm, 77 kg
	Packing	760 × 800 × h1120 mm, 80 kg	730 × 810 × h1130 mm, 92 kg
Power Consumption		340 W	610 W
Electric Reqts.		110V, 60Hz or 220V, 50/60Hz, 1 Phase	
Cat. No.	220V	DH.Inc8001	DH.Inc8002
	110V	DH.Inc8011	DH.Inc8012
Price, Each. ₩			

* Other Specifications are available upon Customer's Request.

※ 운임 별도!

Spare Accessory

- DH.IncA1001 (1) Perforated Shelf, STS, for "ICA-100", w440×d400 mm
- DH.IncA1002 , for "ICA-150", w485×d445 mm
- DH.IncA1005 (2) UV Lamp 254 nm, φ30×205 mm, for "ICA"

Ea. Price, ₩

Optional Accessory

- H11.801.10M (3) Regulator, Single-stage, 150psi, Air, CO₂, Argon, Nitrogen, Helium

Ea. Price, ₩

Air-jacketed CO₂ Incubator with Validation (IQ, OQ) Service

- DH.IncA5001 Validation Service(IQ, OQ), with "ICA-100"
- DH.IncA5002 , with "ICA-150"

Set. Price, ₩

DAIHAN® 4~45°C & 0~10% CO₂ 20Lit Mini CO₂ Incubator & CO₂ Shaking Incubator, "ThermoStable™ IC-20 & ICS-20" Programmable PID Controlled 0.1°C & 0.1%, Compact Design for Saving Space/Money, Ideal for Cell/Tissue Culture **NEW**
 With Cooling/Heating system of Peltier Element/Auto-Tuning/Safety Device, 저온 미니 CO₂ 배양기 & CO₂ 진탕 배양기



A. 20Lit Mini CO₂ Incubator "ThermoStable™ IC-20" Including CO₂ Gas Cylinder & Regulator

- A. Standard CO₂ Incubator "ThermoStable™ IC-20" Including CO₂ Regulator & CO₂ Aluminum Cylinder
- B. Assembly CO₂ Shaking Incubator Package Set "ThermoStable™ ICS-20" = Standard CO₂ Incubator "IC-20" + Orbital Shaker "SHO-1DI"
- C. Multiuse Digital Orbital Motion Shaker "SHO-1DI" : Can Be Used Individually. "SHO-1DI" is same with existing Orbital Shaker "SHO-1D" except Platform, and can be Accepted Optional Various Platforms ; See the Shaker Section

- Made in Korea ■ PL(Product Liability) Insurance ■ 2-Year Warranty
- Applications : Cell/Tissue Culture & Transfer, Embryo/Microorganism Culture
- NDIR CO₂ Sensor : Dual Wavelength Type Rapid Initial Response Time, not Affected by User Environment
- ABS-Resin Chamber & Housing : Light-weight/Compact Design Good for Money & Space Saving and Personal Use.
- Certificate & Traceability : Controlled by Serial Number, Certificate, Delivery-Information, and Traceable Data Base System.

- * Cooling/Heating System of PELTIER ELEMENT :
 - Cooling and Heating by using Thermoelectric Semiconductor Element
 - Minimizes Noise(<20dB) and Power Consumption
- * Auto-Tuning : Rapid Response and High Stability According to the Thermal Properties and the Rate of Thermal Response of the Object
- * Safety Device : Over Temperature & Over Current Protection, Sensor Error Detection
- * 4-Connection Device to Join a Shaker "SHO-1DI" in the Bottom outside of the CO₂ Incubator "IC-20"

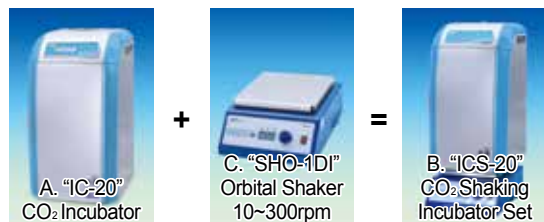

Figure; Assembly CO₂ Shaking Incubator You can easily connect the Incubator & Shaker

Specifications & Ordering Information

Spec.	Model	A. CO ₂ Standard Incubator "ThermoStable™ IC-20"	B. CO ₂ Shaking Incubator Set "ThermoStable™ ICS-20"
Capacity (Lit)		20Lit Working Chamber	
Temp. Range Accuracy Uniformity		4 ~ 45°C, 0.1°C; Digital PID Control ±0.2°C (No Load) ±0.2°C (at 37°C)	
CO ₂ Range & Control		0 ~ 10%, 0.1% ; NDIR CO ₂ Sensor	
Cooling/Heating		Peltier Element Module	
Air Flow-type		Gravity Flow Circulation	
1 Shelf and 3 Location Brackets		1 Perforated ABS Shelf(w210×d230×Thick 8mm) included Adjustable Shelf Location Height of 3-Stage	
Condensate Drain		Natural Evaporation	
Incubator Material		"ABS-Resin" Chamber & Housing, Except Shaking Base	
Incubator Dimension	Interior	w213×d265×h360mm Chamber Only	
	Exterior	w280×d330×h510mm	w280×d330×h670mm; Including Shaking Base
C. SHAKING-Base; Connecting the Multiuse Shaking "SHO-1DI"			
- Motion & Speed			- Orbital, 10 ~ 300rpm, 8mm Stroke
- Controller & Display			- Programmable Digital Feedback, LCD
- Timer & Alarm			- 99hr 59min with ∞ Run, Error Status & Time End
- Motor & Max-Load			- Brushless DC Motor; Max-Load 10kg
- Safety Circuit			- Overload Protector of Motor
- Material			- Powder Coated Steel Body
- Size & Weight			- w260×d330×h140mm, 14kg
Net Weight (kg)		10kg	10kg+ 14kg Shaking Base ("SHO-1DI") = 24kg
Power Consumption		56W	56W+40W (Shaking)
Electric Reqts.		Free Voltage; 1Phase, AC90-240V, 50/60Hz	



B. "ICS-20" CO₂ Shaking Incubator Set

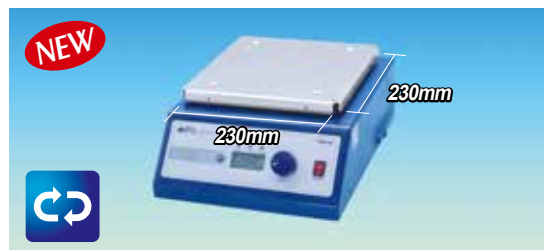

C. "SHO-1DI" Separable Orbital Shaker ; It can be Used Individually and Be Accepted

C. SHAKING-Base; Orbital Shaker

DH.SHO01DI Shaker "SHO-1DI", 230V
 DH.SHO01DI.1 , 120V

Ea. Price, ₩

※ Note! Details of Optional Various Platforms : See The "Shaker" Section

DAIHAN® 4~45°C 20 Lit Mini-Low Temperature Incubator & Shaking Incubator, "ThermoStable™ IR-20 & IRS-20" NEW
 2-Step Programmable PID Controlled 0.1°C, Compact Design for Saving Space/Money, Ideal for Culture & Storage of Microorganism/Clone
 With Cooling/Heating system of Peltier Element/Auto-Tuning/Safety Device, **저온 미니-배양기&진탕 배양기, 20Lit, 4~45°C/0.1°C**



A. 20Lit Mini-Low Temp Incubator "ThermoStable™ IR-20"

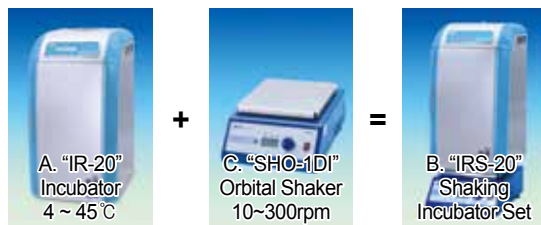

*Figure; Assembly Shaking Incubator
 You can easily connect the Incubator & Shaker*



B. "IRS-20" Low Temp. Shaking Incubator Set

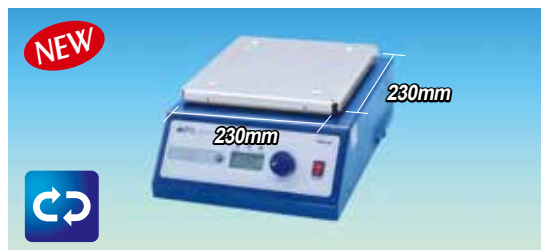

C. "SHO-1DI" Separable Orbital Shaker

; It can be Used Individually and Be Accepted

A. Standard Incubator "ThermoStable™ IR-20"

B. Assembly Shaking Incubator Package Set

"ThermoStable™ IRS-20" = "IR-20" Incubator + Orbital Shaker "SHO-1DI"

C. Multiuse Digital Orbital Motion Shaker "SHO-1DI" : Can be Used Individually.

It is same with existing Orbital Shaker "SHO-1D" except Platform and The Shaker "SHO-1DI" can be Accepted Optional Various Platforms; See "Shakers" Section

- Made in Korea ■ PL(Product Liability) Insurance ■ 2-Year Warranty
- Applications Microorganism / Clone Culture & Storage, Reaction Experiment of Enzyme Immunity & Bacteriophage in Vitro Packaging, DNA Ligation, etc.
- 2-Step Temperature Control(PID Micro Processor) ; With 2-Step Setting Temp. Microorganism is Cultivated and Preserved by One Time(Setting time 99 hours)
- ABS-Resin Chamber & Housing; Light-weight / Compact Design Good for Money & Space Saving and Personal Use.
- Certificate & Traceability : Controlled by Serial Number, Certificate, Delivery-Information, and Traceable Data Base System.

- * Cooling / Heating System of PELTIER ELEMENT ;
 - Cooling and Heating by using Thermoelectric Semiconductor Element
 - Minimizes Noise (<20dB) and Power Consumption
- * Auto Tuning : Rapid Response and High Stability According to the Thermal Properties and the Rate of Thermal Response of the Object
- * Safety Device : Over Temperature & Over Current Protection, Sensor Error Detection
- * There are 4-Connection Device to Join a Shaker "SHO-1DI" in the Bottom outside of the Incubator "IR-20"

Specifications & Ordering Information

Spec.	Model	A. Standard Incubator "ThermoStable™ IR-20"	B. Shaking Incubator Set "ThermoStable™ IRS-20"
Capacity (Lit)		20Lit Working Chamber	
Temp. Range		4°C ~ 45°C, 0.1°C; Digital PID Control	
Accuracy		±0.2°C (No Load)	
Uniformity		±0.2°C (at 37°C)	
Cooling / Heating		Peltier Element Module	
2-Step Operation		Ideal for Cultivation and Preservation	
Air Flow-type		Gravity Flow Circulation	
1 Shelf and 3 Location Brackets		1 Perforated ABS Shelf(w210×d230×Thick 8mm) included Adjustable Shelf Location Height of 3-Stage	
Condensate Drain		Natural Evaporation	
Incubator Material		"ABS-Resin" Chamber & Housing, Except Shaking Base	
Incubator Dimension	Interior	w213×d265×h360mm Chamber Only	
	Exterior	w280×d330×h510mm	w280×d330×h670mm; Including Shaking Base
C. SHAKING-Base; Connecting the Multiuse Shaking "SHO-1DI"			
- Motion&Speed			- Orbital, 10 ~ 300rpm, 15mm Stroke
- Controller&Display			- Programmable Digital Feedback, LCD
- Timer&Alarm			- 99hr 59min with ∞ Run, Error Status & Time End
- Motor&Max-Load			- Brushless DC Motor, Max-Load 10kg
- Safety Circuit			- Overload Protector of Motor
- Material			- Powder Coated Steel Body
- Size&Weight			- w260×d330×h140mm, 14kg
Net Weight (kg)		7kg	7kg+14kg Shaking Base ("SSO-1DI") = 21kg
Packing Size & Weight		9kg	25kg
Power Consumption		56W	56W+40W (Shaking)
Electric Reqts.		Free Voltage; 1Phase, AC90-240V, 50 / 60Hz	
Cat. No.	230V	DH.IncR020	DH.IncRS020
	120V	DH.IncR020.1	DH.IncRS020.1
Price, Set. ₩			

C. SHAKING-Base; Orbital Shaker

DH.SHO01DI Shaker "SHO-1DI", 230V
 DH.SHO01DI.1 , 120V

Ea.	Price, ₩

※ Note! Details of Optional Various Platforms : See The "Shaker" Section

Maximum Convenience by Advanced Digital Technology

Features of DAIHAN Incubator



High Performance Heating Mechanism of DAIHAN accomplishing world's best temperature accuracy and uniformity

The new types of Incubator of DAIHAN are outfitted with high performance heating mechanism that is optimized respectively for capacity of chamber, power of heating element and air circulation type (Gravity Convection or Forced Convection).

The temperature displayed on the controller is accurately consistent with the actual temperature in the very center of the chamber or the average temperature in the entire area of the chamber, which maintains precisely within fluctuation specification. In addition, the temperature in the entire area of the chamber shows a very high stability keeping within a very slight variation specification in terms of temperature uniformity. Simultaneously, through the optimization of Fuzzy-PID controller, the 'heat-up time' to reach the Set Temperature after operating and the 'recovery time' to get back to the set temperature after opening and closing of the door are very short.

The newly developed high performance heating mechanism has achieved high degree of temperature accuracy and uniformity in the chamber. This is achieved by the heating elements installed on three sides - that is, the left, right and bottom parts of a chamber - which directly heat the stainless-steel chamber. This either enhances its material thermal conductivity to maximum (in case of the Incubator) or the heated air from the pre-heating zone in air-jacket type that is built in the three sides outside a chamber circulates first (in case of the Oven).

» Incubator

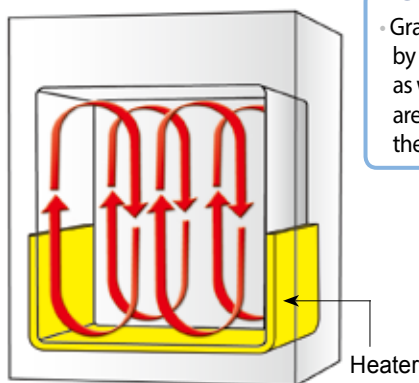

Gravity-air

- Gravity convection is to be supplemented and maximized by way of forming radiant and conductive heat on the bottom as well as both sides of the chamber, while heating elements are fitted closely to the three sides outside the chamber by the steel structure of 1.5mm in thickness.

Forced-air

- The same heating structure as Gravity Air-Flow model.
- Installs an air-flow room with a fan built in the back side of the chamber to achieve effective forced convection.
- Achieves high temperature uniformity and minimizes mutual contamination between samples by maintaining air flow in forced convection to top.

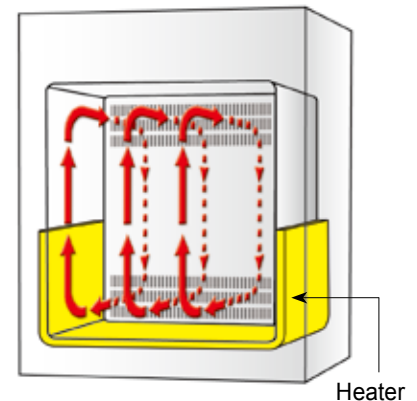

■ High Performance Heating Mechanism

The world's best performance and quality coming true via innovative heating mechanism !!

» Minimum

Fluctuation !

Minimization of Fluctuation in Temperature

Variation !

Minimization of spatial variation in temperature inside the chamber

Heat-up Time !

Minimization of reaching the set temperature

Overshoot !

Minimization of overshooting at the time of reaching the set temperature

DAIHAN® Forced-air Incubator “ThermoStable™ IF”, **Class-I Medical Device(NIDS)**, 50 · 105 · 155 Lit
 With 2 Wire Shelf/Digital PID Control/Jog-Dial & Push Button/Digital LCD/Backlight/Certi. & Traceability, up to 70°C, ±0.2°C
 강제 순환식 배양기/인큐베이터, 디지털 퍼지 컨트롤, 우수한 온도균일성



“ThermoStable™ IF-105”, Forced-air Incubator

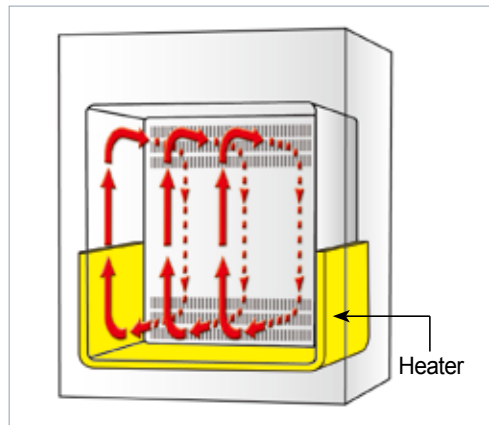

3-Side Heating Zone : The Best Temp. Uniformity & Accuracy by High Performance Heating Mechanism.

- Made in Korea ■ UL / CUL Certified ■ CE Certified
- with Certificate & Traceability : Controlled by Serial Number, Certificate, Delivery-information, and Traceable Data Base System
- Optimized Air Flow by Forced-air Mechanism
- 3-Side Heating Mechanism : The Best Temp. Uniformity & Accuracy by High Performance Heating Mechanism
- Patented Jog-Dial Control System
- GD(Good Design)-mark ■ PL(Product Liability) Insurance
- * Various Application : Microorganism Culture, Animal & Plant Cell Culture, Constant Temp., Germination, and so on
- * Optimized Air Flow by Forced-air Mechanism
- * Digital PID Control System Implementing Superior Temperature Accuracy
- * Alarm Function : Error status and Timer-end
- * RS232C Interface for Monitoring and Controlling with PC
- * Ambient to 70°C of Temp. Range, Fluctuation of ± 0.2°C at 37°C, ± 0.3°C at 50°C
- * Storage Function of Temperature and Timer setting values
- * Locking Mode Supported for Experimental Safety (Input to Jog-Dial can be disabled)
- * Corrosion Resistant 304 Stainless-steel Chamber
- * Incubator Temperature & Incubator Current Protection, Sensor Error Detection

Specification

Spec.	Model	ThermoStable™ IF-50	ThermoStable™ IF-105	ThermoStable™ IF-155
		Max. Capa. 50Lit	Max. Capa. 105Lit	Max. Capa. 155Lit
Capacity		50 Lit	105 Lit	155 Lit
Dimension (w×d×h)	Interior (mm)	370×350×419	485×410×533	550×475×600
	Exterior (mm)	518×637×700	635×695×841	700×760×906
Heater Power		200W	300W	400W
Temp.	Range	Room Temp. +5°C to 70°C		
	Fluctuation	± 0.2°C at 37°C, ± 0.3°C at 50°C		
	Variation	± 0.5°C at 37°C, ± 0.9°C at 50°C	± 0.4°C at 37°C, ± 0.7°C at 50°C	
	Sensor	PT 100		
Control Resolution		±0.1°C		
Heat-up Time		17 min. to 37°C, 28 min. to 50°C	17 min. to 37°C, 30 min. to 50°C	
Recovery Time (Door open 30sec)		3 min. to 37°C, 4 min. to 50°C		
Controller		Digital PID Control by Advanced Microprocessor Jog-Dial with Push Button		
RS232 Port		Available to connect with PC		
Display		Digital LCD with Back Light		
Timer		99hr 59 min (delay/continuous function)		
Material	Internal	Stainless-steel (#304)		
	External	Powder Coated steel		
	Inner Door	Inner Tempered Glass Door		
Shelf		2ea of PE-coated steel Wire Shelf included, Load per Shelf : 16 kg		
Ventilation		1ea of Ventilation hole with Stainless-steel Cap, Hole Diameter 40mm		
Circulation		Forced-air Type		
Safety device		Over Temp. and Over Current Protector, Sensor Error Detector		
Others		UL/CUL Certified, CE Certified, GD-mark Storage Function(Temp. and Time) Locking Mode(Jog-Dial Input Disabled) Alarm (Error Status and Timer-end)		
Net Weight (kg)		46	66	81
Packing Size (w×d×h) (mm)		628×752×775	710×731×1,018	731×810×1,018
Shipping Weight (kg)		58	74	92
Power Consumption		216.3 W	302.9 W	438.1 W
Energy Consumption, at 37°C, at 50°C		28 Wh	43 Wh	58 Wh
		84 Wh	129 Wh	145 Wh
Electrical Reqts.		120V, 60Hz or 230V, 50/60Hz		

* Other Specifications are available upon Customer's Request.

<Continued On Next Page>

Cat. No	Description	Articles
---------	-------------	----------

<Continued From...DAIHAN® Forced-air Incubator “ThermoStable™ IF”>

※ 운임 약 ₩ 25,000 별도!

Ordering Information

DH.WIF03050	Incubator, Forced, 230V, 50 Lit, “ThermoStable IF-50”	Ea. Price, ₩
DH.WIF03105	, 105 Lit, “ThermoStable IF-105”	
DH.WIF03155	, 155 Lit, “ThermoStable IF-155”	
DH.WIF04050	Incubator, Forced, 120V, 50 Lit, “ThermoStable IF-50”	
DH.WIF04105	, 105 Lit, “ThermoStable IF-105”	
DH.WIF04155	, 155 Lit, “ThermoStable IF-155”	

Spare PE-coated Steel Wire Shelf

DH.WIG11050	Wire Shelf, PE-coated Steel, with 2 Brackets, for 50 Lit, “IGS050”, w340 × d310mm	Ea. Price, ₩
DH.WIG11105	Wire Shelf, PE-coated Steel, with 2 Brackets, for 105 Lit, “IGS105”, w455 × d375mm	
DH.WIG11155	Wire Shelf, PE-coated Steel, with 2 Brackets, for 155 Lit, “IGS155”, w520 × d440mm	

Optional Stainless-steel Wire Shelf

DH.WON11050	Wire Shelf, Stainless-steel, with 2 Brackets, for 50 Lit, “ONS050”, w340 × d310mm	Ea. Price, ₩
DH.WON11105	Wire Shelf, Stainless-steel, with 2 Brackets, for 105 Lit, “ONS105”, w455 × d375mm	
DH.WON11155	Wire Shelf, Stainless-steel, with 2 Brackets, for 155 Lit / 305Lit, “ONS155”, w520 × d440mm	

Forced Convection Incubator with Validation (IQ, OQ) Service

DH.WIF31050	Validation Service(IQ, OQ), with “ThermoStable IF-50”, “IFV050”	Ea. Price, ₩
DH.WIF31105	, with “ThermoStable IF-105”, “IFV105”	
DH.WIF31155	, with “ThermoStable IF-155”, “IFV155”	

» **New Jog-Dial Controller**

⑤ Digital LCD with Back-light Function

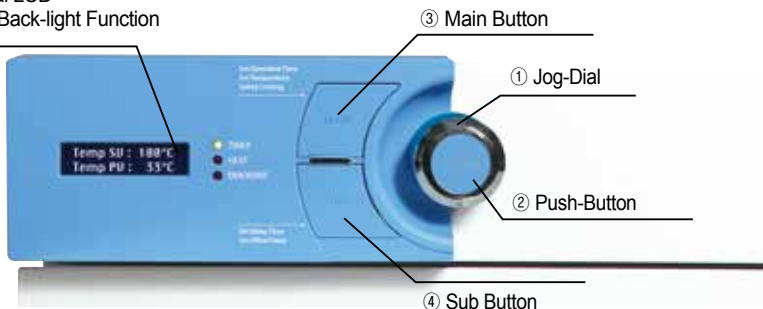

- Provides the user interface with an ergonomic design for users to operate in an easy and convenient way.
- A new 2-way Jog-Dial Knob (Jog Dial + Push Button) and presents excellent durability and mobility.
- High-quality LCD with Back-light function.
- A durable Main Button and a Sub Button that features superb and user-friendly operation.



“ThermoStable IF-105”, Forced-air Incubator



Wire Shelf, PE-coated Steel (Included)

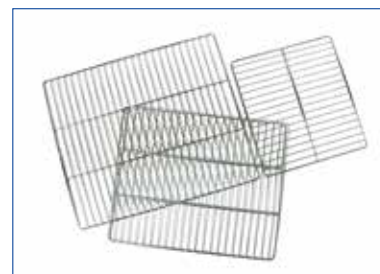

Wire Shelf, Stainless-steel (Optional)



WiseRemote Control Software :

Connection of Temperature Devices with Interface RS232C to a PC
Export Recorded Data(Excel Spreadsheet)

* You can Download this Software from DAIHAN-Sci.com Shopping-mall

DAIHAN[®] SMART Forced-air Incubator “ThermoStable™ SIF”, 50 · 105 · 155 Lit, 3-Side Heating Zone
 With **Smart-Lab™ Controller**/4” Full Touch Screen/Fuzzy-PID Control/2 Wire Shelf/Certi. & Traceability, up to 70℃, ±0.2℃
 스마트 강제 순환식 배양기/인큐베이터, 우수한 온도균일성, WiRe™서비스, 4인치 풀터치스크린 조절기



“ThermoStable™ SIF-105”, SMART Forced-air Incubator

- Made in Korea ■ UL / CUL Certified ■ CE Certified
- with Certificate & Traceability : Controlled by Serial Number, Certificate, Delivery-information, and Traceable Data Base System
- Optimized Air Flow by Forced-air Mechanism
- 3-Side Heating Mechanism : The Best Temp. Uniformity & Accuracy by High Performance Heating Mechanism
- Smart-Lab™ Controller
- GD(Good Design)-mark ■ PL(Product Liability) Insurance
- * Various Application : Microorganism Culture, Animal & Plant Cell Culture, Constant Temp, Germination, and so on
- * Optimized Air Flow by Forced-air Mechanism
- * Ergonomic Design 4” Full Touch Screen TFT LCD(Smart-Lab™ Controller)
- * WiRe™ App Service. * Automatic Data Recording
- * Self-Diagnostic Function * Internet Connectivity with WiFi
- * Variable Program Setting for Multiple Patterns with Multiple Segments
- * The Recorded Data Could be transferred to PC by USB memory
- * Compact New Body Design * Controller SW can be upgraded through USB port.
- * 2ea of PE-coated steel Wire Shelves Included
- * RS232C Interface for Monitoring and Controlling with PC
- * Ambient to 70℃ of Temp. Range, Fluctuation of ±0.2℃ at 37℃, ±0.3℃ at 50℃
- * Corrosion Resistant 304 Stainless-steel Chamber
- * Incubator Temperature & Incubator Current Protection, Sensor Error Detection

Specification

Spec.	Model	ThermoStable™ SIF-50	ThermoStable™ SIF-105	ThermoStable™ SIF-155
		Max. Capa. 50Lit	Max. Capa. 105Lit	Max. Capa. 155Lit
Capacity		50 Lit	105 Lit	155 Lit
Dimension (w×d×h)	Interior (mm)	370×350×419	485×410×533	550×475×600
	Exterior (mm)	518×637×700	635×695×841	700×760×906
Heater Power		200W	300W	400W
Temp.	Range	Room Temp. +5℃ to 70℃		
	Fluctuation	± 0.2℃ at 37℃, ± 0.3℃ at 50℃		
	Variation	± 0.5℃ at 37℃, ± 0.9℃ at 50℃	± 0.4℃ at 37℃, ± 0.7℃ at 50℃	
	Sensor	PT 100		
Control Resolution		±0.1℃		
Heat-up Time		17 min. to 37℃, 28 min. to 50℃	17 min. to 37℃, 30 min. to 50℃	
Recovery Time (Door open 30sec)		3 min. to 37℃, 4 min. to 50℃		
Controller		Smart-Lab™ Controller		
RS232		Port Available to connect with PC		
Display		4” Full Touch Screen TFT LCD		
Timer		99hr 59 min (delay/continuous function)		
Material	Internal	Stainless-steel (#304)		
	External	Powder Coated steel		
	Inner Door	Inner Tempered Glass Door		
Shelf		2ea of PE-coated steel Wire Shelf included, Load per Shelf : 16 kg		
Ventilation		1ea of Ventilation hole with Stainless-steel Cap, Hole Diameter 40mm		
Circulation		Forced-air Type		
Safety device		Over Temp. and Over Current Protector, Sensor Error Detector		
Others		UL/CUL Certified, CE Certified, GD-mark Storage Function (Temp. and Time) Alarm (Error Status and Timer-end)		
Net Weight (kg)		46	66	81
Packing Size (w×d×h) (mm)		628×752×775	710×731×1,018	731×810×1,018
Shipping Weight (kg)		58	74	92
Power Consumption		216.3 W	302.9 W	438.1 W
Energy Consumption, at 37℃, at 50℃		28 Wh	43 Wh	58 Wh
		84 Wh	129 Wh	145 Wh
Electrical Reqt.s.		120V, 60Hz or 230V, 50/60Hz		

* Other Specifications are available upon Customer's Request.

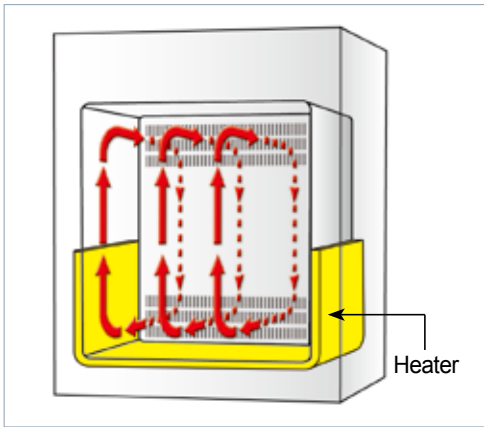

3-Side Heating Zone : The Best Temp. Uniformity & Accuracy by High Performance Heating Mechanism.



Display of Smart-Lab™ Controller

<Continued On Next Page>

Cat. No	Description	Articles
---------	-------------	----------

<Continued From...DAIHAN® SMART Forced-air Incubator "ThermoStable™ SIF">

※ 운임 약 ₩ 25,000 별도!

Ordering Information

		Ea. Price, ₩
DH.SWIF03050	Incubator, Forced, 230V, 50 Lit, "ThermoStable SIF-50"	
DH.SWIF03105	, 105 Lit, "ThermoStable SIF-105"	
DH.SWIF03155	, 155 Lit, "ThermoStable SIF-155"	
DH.SWIF04050	Incubator, Forced, 120V, 50 Lit, "ThermoStable SIF-50"	
DH.SWIF04105	, 105 Lit, "ThermoStable SIF-105"	
DH.SWIF04155	, 155 Lit, "ThermoStable SIF-155"	

Spare PE-coated Steel Wire Shelf

		Ea. Price, ₩
DH.WIG11050	Wire Shelf, PE-coated Steel, with 2 Brackets, for 50 Lit, "IGS050", w340×d310mm	
DH.WIG11105	Wire Shelf, PE-coated Steel, with 2 Brackets, for 105 Lit, "IGS105", w455×d375mm	
DH.WIG11155	Wire Shelf, PE-coated Steel, with 2 Brackets, for 155 Lit, "IGS155", w520×d440mm	

Optional Stainless-steel Wire Shelf

		Ea. Price, ₩
DH.WON11050	Wire Shelf, Stainless-steel, with 2 Brackets, for 50 Lit, "ONS050", w340×d310mm	
DH.WON11105	Wire Shelf, Stainless-steel, with 2 Brackets, for 105 Lit, "ONS105", w455×d375mm	
DH.WON11155	Wire Shelf, Stainless-steel, with 2 Brackets, for 155 Lit, "ONS155", w520×d440mm	

SMART Incubator with Validation (IQ, OQ) Service

		Ea. Price, ₩
DH.SWIF31050	Validation Service(IQ, OQ), with "SIF-50", "SIFV050"	
DH.SWIF31105	, with "SIF-105", "SIFV105"	
DH.SWIF31155	, with "SIF-155", "SIFV155"	



"ThermoStable SIF-105", SMART Forced-air Incubator



Wire Shelf, PE-coated Steel (Included)

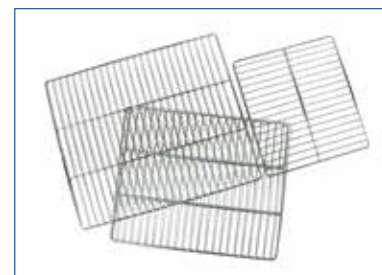

Wire Shelf, Stainless-steel (Optional)

» DAIHAN WiRe™ App Service



4" Full Touch Screen TFT LCD (Smart-Lab™ Controller)

It is possible to monitor and control the Smart-Lab™ equipment through all smart phone, tablet without restraint of time and place.



WiRe™ App Service

Controlled by Smart-Phone

DAIHAN® Gravity-air Incubator “ThermoStable™ IG”, **Class I Medical Device(NIDS)**, 32 · 50 · 105 · 155 Lit
 With 2 Wire Shelf/Digital PID Control/Jog-Dial & Push Button/Digital LCD & Backlight, Certi. & Traceability, up to 70°C, ±0.2°C
 자연 대류식 배양기/인큐베이터, 디지털 퍼지 컨트롤, 우수한 온도 균일도와 정확도



“ThermoStable™ IG-105”, Gravity-air Incubator

- Made in Korea
- UL / CUL Certified
- CE Certified
- with Certificate & Traceability : Controlled by Serial Number, Certificate, Delivery-information, and Traceable Data Base System
- Optimized Air Circulation by Gravity-air preventing Cross Contamination of Samples
- 3-Side Heating Mechanism : The Best Temp. Uniformity & Accuracy by High Performance Heating Mechanism
- Patented Jog-Dial Control System
- GD(Good Design)-mark
- PL(Product Liability) Insurance
- * Various Application : Microorganism Culture, Animal & Plant Cell Culture, Constant Temp Germination, and so on
- * Optimized Air Circulation by Gravity-air preventing Cross Contamination of Samples
- * Digital PID Control System Implementing Superior Temperature Accuracy
- * RS232C Interface for Monitoring and Controlling with PC
- * Ambient to 70°C of Temp. Range, Fluctuation of ±0.2°C at 37°C, ±0.3°C at 50°C
- * Alarm Function : Error status and Timer-end
- * Storage Function of Temperature and Timer setting values
- * Locking Mode Supported for Experimental Safety (Input to Jog-Dial can be disabled)
- * Corrosion Resistant 304 Stainless-steel Chamber
- * Incubator Temperature & Incubator Current Protection, Sensor Error Detection

Specification

Spec.		Model	ThermoStable™ IG-32 Max. Capa. 32L	ThermoStable™ IG-50 Max. Capa. 50L	ThermoStable™ IG-105 Max. Capa. 105L	ThermoStable™ IG-155 Max. Capa. 155L
Capacity			32 Lit	50 Lit	105 Lit	155 Lit
Dimension (w×d×h)	Interior (mm)		312×290×360	370×350×420	485×410×535	550×475×600
	Exterior (mm)		458×477×624	518×537×701	635×595×841	700×660×906
Heater Power			150W	200W	300W	400W
Temp.	Range		Range Room Temp. +5°C to 70°C			
	Fluctuation		± 0.2°C at 37°C, ± 0.3°C at 50°C			
	Variation		± 0.6°C at 37°C, ± 1.0°C at 50°C			
	Sensor		PT 100			
Control Resolution			±0.1°C			
Heat-up Time			25 min. to 37°C, 40 min. to 50°C		30 min. to 37°C, 40 min. to 50°C	
Recovery Time (Door open 30sec)			8 min. to 37°C 12 min. to 50°C		10 min. to 37°C 15 min. to 50°C	
Controller			Digital PID Control by Advanced Microprocessor Jog-Dial with Push Button			
RS232			Available to connect with PC			
Display			Digital LCD with Back Light			
Timer			99hr 59 min (delay/continuous function)			
Material	Internal		Stainless-steel (#304)			
	External		Powder Coated steel			
	Inner Door		Inner Tempered Glass Door			
Shelf			2ea of PE-coated Steel Wire Shelf included, Load per Shelf : 16 kg			
Ventilation			1ea of Ventilation hole with Stainless-steel Cap, Hole Diameter 40mm			
Circulation			Gravity-air Type			
Safety device			Over Temp. and Over Current Protector, Sensor Error Detector			
Others			UL/CUL Certified, CE Certified, GD-mark Storage Function (Temp. and Time) Locking Mode (Jog-Dial Input Disabled) Alarm (Error Status and Timer-end)			
Net Weight (kg)			32	40	59	71
Packing Size (w×d×h) (mm)			568×592×698	628×652×775	731×710×1,018	796×775×1,083
Shipping Weight (kg)			39	53	67	78
Power Consumption			159 W	169.9 W	292.9 W	420.5 W
Energy Consumption, at 37°C			34 Wh	41 Wh	63 Wh	99 Wh
, at 50°C			81 Wh	103 Wh	152 Wh	212 Wh
Electrical Reqts.			120V, 60Hz or 230V, 50/60Hz			

* Other Specifications are available upon Customer's Request.

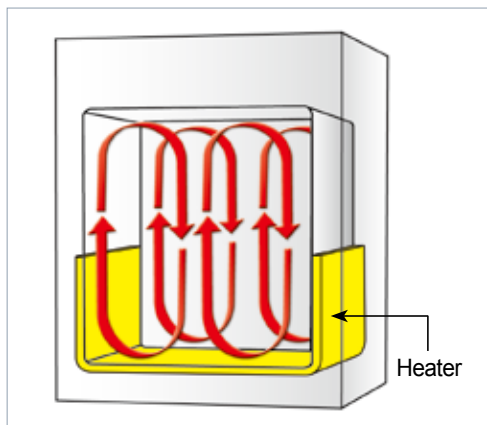

3-Side Heating Zone : The Best Temp. Uniformity & Accuracy by High Performance Heating Mechanism.

<Continued On Next Page>

Cat. No	Description	Articles
---------	-------------	----------

<Continued From...DAIHAN® Gravity-air Incubator “ThermoStable™ IG”>

※ 운임 약 ₩ 25,000 별도!

Ordering Information

		Ea. Price, ₩
DH.WIG03032	Incubator, Gravity, 230V, 32 Lit, “ThermoSatble IG-32”	
DH.WIG03050	, 50 Lit, “ThermoSatble IG-50”	
DH.WIG03105	, 105 Lit, “ThermoSatble IG-105”	
DH.WIG03155	, 155 Lit, “ThermoSatble IG-155”	
DH.WIG04032	Incubator, Gravity, 120V, 32 Lit, “ThermoSatble IG-32”	
DH.WIG04050	, 50 Lit, “ThermoSatble IG-50”	
DH.WIG04105	, 105 Lit, “ThermoSatble IG-105”	
DH.WIG04155	, 155 Lit, “ThermoSatble IG-155”	

Spare PE-coated Steel Wire Shelf

		Ea. Price, ₩
DH.WIG11032	Wire Shelf, PE-coated Steel, with 2 Brackets, for 32 Lit, “IGS032”, w280 × d260mm	
DH.WIG11050	Wire Shelf, PE-coated Steel, with 2 Brackets, for 50 Lit, “IGS050”, w340 × d310mm	
DH.WIG11105	Wire Shelf, PE-coated Steel, with 2 Brackets, for 105 Lit, “IGS105”, w455 × d375mm	
DH.WIG11155	Wire Shelf, PE-coated Steel, with 2 Brackets, for 155 Lit, “IGS155”, w520 × d440mm	

Optional Stainless-steel Wire Shelf

		Ea. Price, ₩
DH.WIG12032	Wire Shelf, Stainless-steel, with 2 Brackets, for 32 Lit, “IGSN032”, w280 × d260mm	
DH.WON11050	Wire Shelf, Stainless-steel, with 2 Brackets, for 50 Lit, “ONS050”, w340 × d310mm	
DH.WON11105	Wire Shelf, Stainless-steel, with 2 Brackets, for 105 Lit, “ONS105”, w455 × d375mm	
DH.WON11155	Wire Shelf, Stainless-steel, with 2 Brackets, for 155 Lit / 305Lit, “ONS155”, w520 × d440mm	

Gravity Convection Incubator with Validation (IQ, OQ) Service

		Ea. Price, ₩
DH.WIG31032	Validation Service(IQ, OQ), with “ThermoSatble IG-32”, “IGV032”	
DH.WIG31050	, with “ThermoSatble IG-50”, “IGV050”	
DH.WIG31105	, with “ThermoSatble IG-105”, “IGV105”	
DH.WIG31155	, with “ThermoSatble IG-155”, “IGV155”	

» New Jog-Dial Controller

⑤ Digital LCD with Back-light Function

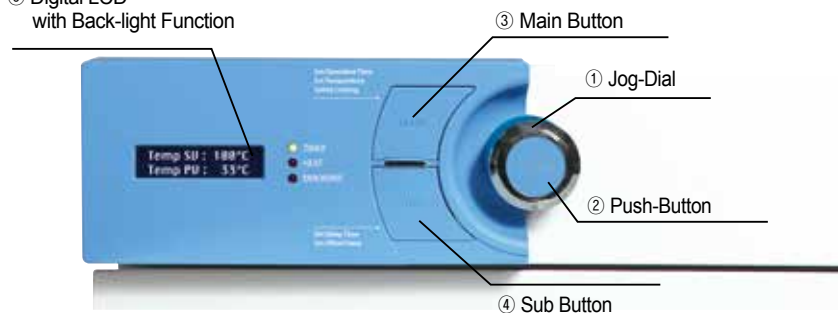

- Provides the user interface with an ergonomic design for users to operate in an easy and convenient way.
- A new 2-way Jog-Dial Knob (Jog Dial + Push Button) and presents excellent durability and mobility.
- High-quality LCD with Back-light function.
- A durable Main Button and a Sub Button that features superb and user-friendly operation.



“ThermoStable IG-105”, Gravity-air Incubator



Wire Shelf, PE-coated Steel (Included)

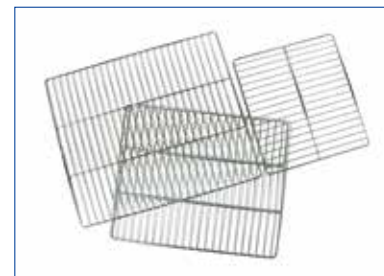

Wire Shelf, Stainless-steel (Optional)



WiseRemote Control Software :

Connection of Temperature Devices with Interface RS232C to a PC
Export Recorded Data(Excel Spreadsheet)

* You can Download this Software from DAIHAN-Sci.com Shopping-mall

DAIHAN® SMART Gravity-air Incubator “ThermoStable™ SIG”, **Class I Medical Device(NIDS)**, 32 · 50 · 105 · 155 Lit With **Smart-Lab™ Controller**/4” Full Touch Screen/Fuzzy-PID Control/2 Wire Shelf/Certi. & Traceability, up to 70℃, ±0.2℃ 스마트 자연 대류식 배양기/인큐베이터, 우수한 온도 균일도와 정확도, WiRe™서비스, 4인치 풀터치스크린 조절기



“ThermoStable™ SIG-105”, SMART Gravity-air Incubator

- Made in Korea
 - UL / CUL Certified
 - CE Certified
 - with Certificate & Traceability : Controlled by Serial Number, Certificate, Delivery-information, and Traceable Data Base System
 - Optimized Air Circulation by Natural Flow preventing Cross Contamination of Samples
 - 3-Side Heating Mechanism : The Best Temp. Uniformity & Accuracy by High Performance Heating Mechanism
 - Smart-Lab™ Controller
 - GD(Good Design)-mark
 - PL(Product Liability) Insurance
- * Various Application : Microorganism Culture, Animal & Plant Cell Culture, Constant Temp., Germination, and so on
- * Corrosion Resistant 304 Stainless-steel Chamber
- * Optimized Air Circulation by Natural Flow preventing Cross Contamination of Samples
- * Ergonomic Design 4” Full Touch Screen TFT LCD(Smart-Lab™ Controller)
- * WiRe™ App Service.
- * Automatic Data Recording
- * Self-Diagnostic Function
- * 2ea of PE-coated steel Wire Shelves Included
- * Variable Program Setting for Multiple Patterns with Multiple Segments
- * The Recorded Data could be transferred to PC by USB memory
- * Controller SW can be upgraded through USB port.
- * Internet Connectivity with WiFi
- * Compact New Body Design
- * RS232C Interface for Monitoring and Controlling with PC
- * Ambient to 70℃ of Temp. Range, Fluctuation of ±0.2℃ at 37℃, ±0.3℃ at 50℃
- * Over Temperature & Over Current Protection, Sensor Error Detection

Specification

Spec.	Model	ThermoStable™ SIG-32	ThermoStable™ SIG-50	ThermoStable™ SIG-105	ThermoStable™ SIG-155
		Max. Capa. 32L	Max. Capa. 50L	Max. Capa. 105L	Max. Capa. 155L
Capacity		32 Lit	50 Lit	105 Lit	155 Lit
Dimension (w×d×h)	Interior (mm)	312×290×360	370×350×420	485×410×535	550×475×600
	Exterior (mm)	458×477×624	518×537×701	635×595×841	700×660×906
Heater Power		150W	200W	300W	400W
Temp.	Range	Room Temp. +5℃ to 70℃			
	Fluctuation	± 0.2℃ at 37℃, ± 0.3℃ at 50℃			
	Variation	± 0.6℃ at 37℃, ± 1.0℃ at 50℃			
	Sensor	PT 100			
Control Resolution		±0.1℃			
Heat-up Time		25 min. to 37℃, 40 min. to 50℃		30 min. to 37℃, 40 min. to 50℃	
Recovery Time (Door open 30sec)		8 min. to 37℃		10 min. to 37℃	
		12 min. to 50℃		15 min. to 50℃	
Controller		Smart-Lab™ Controller			
RS232		Available to connect with PC			
Display		4” Full Touch Screen TFT LCD			
Timer		99hr 59 min (delay/continuous function)			
Material	Internal	Stainless-steel (#304)			
	External	Powder Coated steel			
	Inner Door	Inner Tempered Glass Door			
Shelf		2ea of PE-coated steel Wire Shelf included, Load per Shelf : 16 kg			
Ventilation		1ea of Ventilation hole with Stainless-steel Cap, Hole Diameter 40mm			
Circulation		Gravity-air Type			
Safety device		Over Temp. and Over Current Protector, Sensor Error Detector			
Others		UL/CUL Certified, CE Certified, GD-mark Storage Function (Temp. and Time) Alarm (Error Status and Timer-end)			
Net Weight (kg)		32	40	59	71
Packing Size (w×d×h) (mm)		568×592×698	628×652×775	731×710×1,018	796×775×1,083
Shipping Weight (kg)		39	53	67	78
Power Consumption		159 W	169.9 W	292.9 W	420.5 W
Energy Consumption, at 37℃, at 50℃		34 Wh	41 Wh	63 Wh	99 Wh
		81 Wh	103 Wh	152 Wh	212 Wh
Electrical Reqts.		120V, 60Hz or 230V, 50/60Hz			

* Other Specifications are available upon Customer's Request.

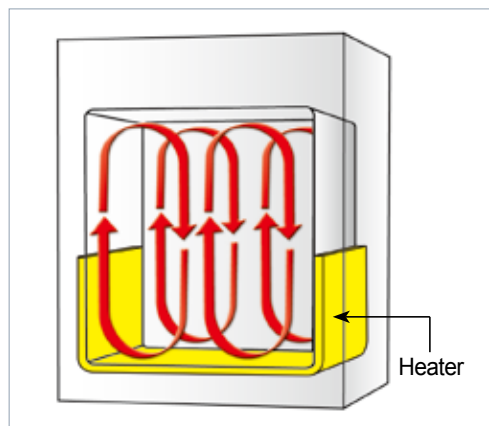

3-Side Heating Zone : The Best Temp. Uniformity & Accuracy by High Performance Heating Mechanism.



Display of Smart-Lab™ Controller

<Continued On Next Page>

Cat. No	Description	Articles
---------	-------------	----------

<Continued From...DAIHAN® SMART Gravity-air Incubator “ThermoStable™ SIG”>

※ 운임 약 ₩ 25,000 별도!

Ordering Information

DH.SWIG03032	Incubator, Gravity, 230V, 32 Lit, “ThermoStable SIG-32”
DH.SWIG03050	, 50 Lit, “ThermoStable SIG-50”
DH.SWIG03105	, 105 Lit, “ThermoStable SIG-105”
DH.SWIG03155	, 155 Lit, “ThermoStable SIG-155”
DH.SWIG04032	Incubator, Gravity, 120V, 32 Lit, “ThermoStable SIG-32”
DH.SWIG04050	, 50 Lit, “ThermoStable SIG-50”
DH.SWIG04105	, 105 Lit, “ThermoStable SIG-105”
DH.SWIG04155	, 155 Lit, “ThermoStable SIG-155”

Ea. Price, ₩



Spare PE-coated Steel Wire Shelf

DH.WIG11032	Wire Shelf, PE-coated Steel, with 2 Brackets, for 32 Lit, “IGS032”, w280 × d260mm
DH.WIG11050	Wire Shelf, PE-coated Steel, with 2 Brackets, for 50 Lit, “IGS050”, w340 × d310mm
DH.WIG11105	Wire Shelf, PE-coated Steel, with 2 Brackets, for 105 Lit, “IGS105”, w455 × d375mm
DH.WIG11155	Wire Shelf, PE-coated Steel, with 2 Brackets, for 155 Lit, “IGS155”, w520 × d440mm

Ea. Price, ₩

Optional Stainless-steel Wire Shelf

DH.WIG12032	Wire Shelf, Stainless-steel, with 2 Brackets, for 32 Lit, “IGSN032”, w280 × d260mm
DH.WON11050	Wire Shelf, Stainless-steel, with 2 Brackets, for 50 Lit, “ONS050”, w340 × d310mm
DH.WON11105	Wire Shelf, Stainless-steel, with 2 Brackets, for 105 Lit, “ONS105”, w455 × d375mm
DH.WON11155	Wire Shelf, Stainless-steel, with 2 Brackets, for 155 Lit, “ONS155”, w520 × d440mm

Ea. Price, ₩

SMART Incubator with Validation (IQ, OQ) Service

DH.SWIG31032	Validation Service(IQ, OQ), with “SIG-32”, “SIGV032”
DH.SWIG31050	, with “SIG-50”, “SIGV050”
DH.SWIG31105	, with “SIG-105”, “SIGV105”
DH.SWIG31155	, with “SIG-155”, “SIGV155”

Ea. Price, ₩



Wire Shelf, PE-coated Steel (Included)

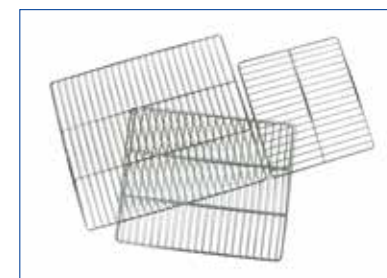

Wire Shelf, Stainless-steel (Optional)

» DAIHAN WiRe™ App Service



4” Full Touch Screen TFT LCD (Smart-Lab™ Controller)

It is possible to monitor and control the Smart-Lab™ equipment through all smart phone, tablet without restraint of time and place.



WiRe™ App Service

Controlled by Smart-Phone

DAIHAN® Multi-Room Incubator “WIM”, Forced-air, 125 Lit × 4 Rooms, with Certi. & Traceability, up to 60/70°C
With 8 Wire Shelf, Digital Fuzzy Control, Independent Chamber Control, Max. Temp. Uniformity & Accuracy

4-룸 배양기/인큐베이터, 강제 순환식, 디지털 퍼지 제어, 개별 컨트롤러 장착



Multi-Room Incubator, Forced-air, “WIM-R4”

- Made in Korea
- UL/CUL Certified
- CE Certified
- with Certificate & Traceability : Controlled by Serial Number, Certificate, Delivery-information, and Traceable Data Base System
- Patented Jog-Shuttle Control System
- PL(Product Liability) Insurance

- * Variable Application : Microorganism Culture, Cell Culture, Constant Temp. Germination
- * Each Chamber has an Independent Controller for Different Temp and Time Control
- * Forced-air Flow by Silent Fan Motor Implements the Highest Uniformity of Temp in Each Chamber
- * Storage Function for Set Values of Temperature and Time
- * Stainless-steel Chamber and PE-coated Shelves (2ea for Each Chamber) - Corrosion Resistance
- * Inner Tempered Glass Door : to Observe the Samples without Interruption of Incubation
- * Over Temperature & Over Current Protection, Sensor Error Detection and Leakage Breaking.
- * Locking Mode Supported for Experimental Safety (Input to Jog-Shuttle can be Disabled)

Specifications & Ordering information

※ 운임 약 ₩ 95,000 별도!

Spec.	Model	(1) “WIM-4”	(2) “WIM-R4”	(3) “WIM-RL4” with illumination
Temp. Range		R/T +5°C~ 70°C	0°C to 60°C	0°C to 60°C
Circulation		Forced-air(Blower FAN)		
Capacity		125 Lit×4 Rooms		
Illumination		None		FRL 36W×2(×4 Rooms)
Temp.	Accuracy	±0.2°C at 37°C		
	Uniformity	±0.3°C at 37°C, ±0.7°C at 50°C	±0.5°C at 37°C	
Heat-up Time		15 min. to 37°C 30 min. to 50°C	20 min. to 37°C 30 min. to 50°C	
Recovery Time (Door open 30sec)		8 min. to 37°C 10 min. to 50°C	10 min. to 50°C 12 min. to 50°C	
Heating / Compressor		500 W×4ea / None	650 W×4ea / 1/4 HP (×4 Rooms)	
Timer & Alarm		99hr 59min (with delay / Continuous run.), Error status & Timer-end		
Display		Digital LCD with Back-Light Function		
Controller		Digital Fuzzy Controller with Jog-Shuttle Switch (Turn & Push)		
Inner Door		with 4ea of Inner Tempered Glass Door		
Shelf		Included 8ea of PE-coated steel Shelf (2ea × 4 Chambers)		
Permitted Total Load		Total Load 128 kg (16kg × 8 Shelves)		
Safety Circuit		Over Temp. and Over Current Protector, Sensor Error Detector		
Material		Internal : Stainless-steel (# 304), External : Powder Coated steel		
Dimension (w×d×h)	Interior (mm)	500×500×h500 mm (× 4 Rooms)		
	Exterior (mm)	1,655×845×h1,710 mm		
Net Weight / Gross Weight		343kg / 441kg	350kg / 450kg	
Packing Size (w×d×h) (mm)		1,900×1,050×1,950		
Power Consumption		2.6 kW	4.5 kW	4.8 kW
Power Supply*		1 Phase, AC 120V, 60Hz or AC 230V, 50/60Hz	1 Phase AC 120V, 60Hz or AC 230V, 50/60Hz or 3 Phase	

Cat. No.	230V	DH.WIM04125	DH.WIM14125	DH.WIM24125
	120V	DH.WIM05125	DH.WIM15125	DH.WIM25125
	3Phase	-	DH.WIM16125	DH.WIM26125
Price, Each. ₩				

Multi-Room Incubator with Validation (IQ, OQ) Service

- DH.WIM54125 Validation Service(IQ, OQ), with “WIM-4”, “IMV525”
- DH.WIM64125 , with “WIM-R4”, “IMV625”
- DH.WIM74125 , with “WIM-RL4”, “IMV725”

Ea. Price, ₩

Spare PE-coated Steel Wire Shelf

- DH.WIM34125 Wire Shelf, PE-coated steel, with 2 Brackets, “IMS125”
w470×d480mm, for “WIM” 4-Room Incubator

Ea. Price, ₩

Optional Stainless-steel Wire Shelf

- DH.WIM34126 Wire Shelf, Stainless-steel, with 2 Brackets, “IMS126”,
w470×d480mm, for “WIM” 4-Room Incubator

Ea. Price, ₩



Wire Shelf, PE-coated steel (Included)

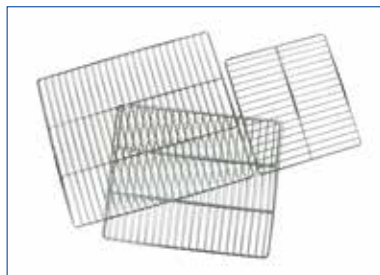

Wire Shelf, Stainless-steel (Optional)

DAIHAN® Premium Compact-size Heating Block/Dry Bath Incubator “MaXtable™ H20”

With Large LCD Display, Fuzzy Control, Molded Heater, Modular Anodized Aluminum Blocks, up to 150°C, ±0.1°C
 히팅 블록, 디지털 퍼지 컨트롤 시스템, 터치버튼식 조절기, 일체형 주물 히터, 블록 교체 가능, 블록 추출용 공구 포함



- Made in Korea ■ CE Certified ■ PL(Product Liability) Insurance
- with Certificate & Traceability : Controlled by Serial Number, Certificate, Delivery-information, and Traceable Data Base System
- Designed for Multi-functional Dry Block Heater ■ Ergonomic Design
- Patented Jog-Dial and Main Touch Button - Best Durability, Best Mobility, Best Convenient to Operate. with Large Back-Light LCD
- With a Screw-type Block Removal Tool ; Convenient Handling
- * High-performance Molded Heater ensures Best Temperature Accuracy.
- * Internal Bath Material(PPS) ensures Best Heat Insulation * Rapid heat up time.
- * Ideal for Enzyme Reactions, Inactivation of Sera, Incubation and Other Laboratory Procedures
- * Precise Temperature Control : ±0.1°C at 37°C, ±0.2°C at 90°C, ±0.4°C at 135°C
- * User Self-Compensation Function to offset between Actual and Displayed Temperature. (±10.0°C)
- * Digital Timer Included : up to 99hr 59min (Operation Time + Delay Time)
- * Storage Function of Temperature and Timer setting values
- * Convenient integral timer for time-sensitive incubations
- * Alarm Function : Error Status and Timer-end * Easy to Read, Wide LCD Screen
- * Locking Mode Supported for Experimental Safety (Input to Jog-Dial can be Disabled)
- * Easily calibrated for accurate temperature control and display

Heating Block/Dry Bath “MaXtable™ H20-set”

Specifications & Ordering information

Spec.	Model	“MaXtable™ H20” (Only Unit)	“MaXtable™ H20-set” (included Standard Block)
Controller		Single Digital Fuzzy Controller	
Useful Block		Interchangeable Block(90×120×h60mm) for Various Tubes	
included Standard Block		None(Only Heating Block Unit)	48 holes×for 1.5/2ml Centri. Tube
Heater		Molded Heater(300W)	
Dimension(mm) & Weight(kg)		Unit : 178×226×h138, Block : 90×120×h60	
Temp. Range, & Accuracy		Ambient +5°C to 150°C, ±0.1°C at 37°C, ±0.2°C at 90°C, ±0.4°C at 135°C	
Heat-Up Speed & Sensor		Approx. 5°C/min, PT100	
Safety Circuit		Over Temp. and Over Current Protector, Sensor Error Detector	
Timer with Alarm		99hr 59min, Alarm (Error Status and Timer - end)	
Display		Digital LCD with Back-Light Function	
Material		Unit : PPS & BAS(HF380), Block : Anodized Aluminum	
Included Standard Acce.		Block Extraction Tool	
Packing Size & Gross Weight		230×290×h245 mm, 2.2 kg	230×355×h245 mm, 3.5 kg
Power Consumption		300 W	
Electric Reqts.		1 Phase, AC 120V, 60Hz or AC 230V, 50 / 60Hz	

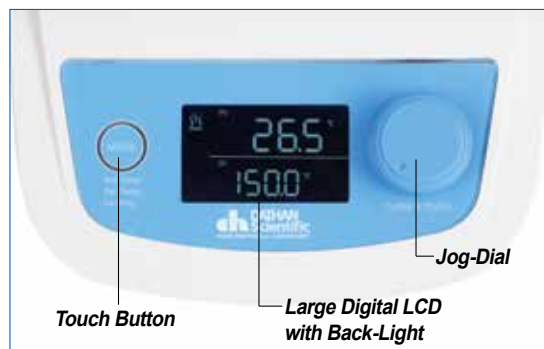

Controller of “MaXtable™ H20”



Included Block (3) “BLC 548” 48holes for 1.5/2ml & Removal Tool

Cat. No.	230V	DH.WHB02000	DH.WHB02100
	120V	DH.WHB02001	DH.WHB02101

Price, Each. ₩

* Other Specifications are available upon Customer's Request.

Optional Interchangeable Anodized Aluminum Block (90×120×h60mm)

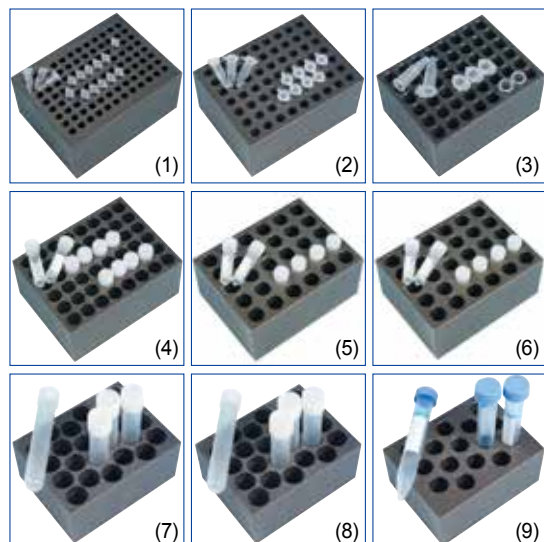

- DH.WHB510596 (1) for 0.2ml PCR Tube, (φ6×h16mm)×96 holes, “BLC596”
- DH.WHB510570 (2) for 0.5ml Centri. Tube, (φ7.7×h29.5mm)×63 holes, “BLC570”
- DH.WHB511548 (3) for 1.5/2ml Centri. Tube, (φ11×h35mm)×48 holes, “BLC548” (* included in the “H20-Set”)
- DH.WHB521248 (4) for φ12mm Test Tube, (φ12×h35mm)×48 holes, “BLT248”
- DH.WHB521335 (5) for φ13mm Test Tube, (φ13×h47mm)×30 holes, “BLT335”
- DH.WHB521535 (6) for φ15mm Test Tube, (φ15×h47mm)×30 holes, “BLT535”
- DH.WHB521628 (7) for φ16.5mm Test Tube, (φ16.5×h47mm)×24 holes, “BLT628”
- DH.WHB521828 (8) for φ18mm Test Tube, (φ18×h47mm)×24 holes, “BLT828”
- DH.WHB531515 (9) for 15ml Conical Tube, (φ16×h47mm)×15 holes, “BLC515”
- DH.WHB535008 (10) for 50ml Conical Tube, (φ28.7×h47mm)×8 holes, “BLC008”
- DH.WHB500102 (11) Spare ; Block Removal Tool, Easy Handling

Ea. Price, ₩

DAIHAN® High-performance Heating Block/Dry Bath Incubator “HB-96D”, Heating, Dual-type
 With Fuzzy Control, Molded Heater, Modular Anodized Aluminum Blocks, Acrylic Lid, Touch-button Controller, up to 150°C, ±0.1°C
 히팅 블록, 디지털 퍼지 컨트롤 시스템, 듀얼 조절기/블럭, 일체형 주물 히터, 블럭 교체 가능, 아크릴 리드/블럭용 집게 포함



- Made in Korea ■ CE Certified ■ PL (Product Liability) Insurance
 - with Certificate & Traceability : Controlled by Serial Number, Certificate, Delivery-information, and Traceable Data Base System
 - Designed for Multi-functional Dry Block Heater
 - Dual Controller & Block
 - Patented Jog-Shuttle Control System and Digital LCD with Back-Light Function
- * Ideal for Enzyme Reactions, Inactivation of Sera, Incubation and Other Laboratory Procedures
 - * Precise Temperature Control : ±0.1°C at 37°C, ±0.2°C at 90°C, ±0.4°C at 135°C
 - * User Self-Compensation Function to offset between Actual and Displayed Temperature. (±10.0°C)
 - * Over Temperature & Over Current Protection and Sensor Error Detection
 - * Digital Timer Included : up to 99hr 59min (Operation Time + Delay Time)
 - * Storage Function of Temperature and Timer setting values * Modular Block
 - * Alarm Function : Error Status and Timer-end * Various kind of Blocks are offered (Optional)
 - * Locking Mode Supported for Experimental Safety (Input to Jog-Shuttle can be Disabled)
 - * The Block Removal Tongs are Included for Easy Handling

Specifications & Ordering information

Spec.	Model	“HB-96D” (Only Unit)	“HB-96D-set” (included Standard Block)
Controller		Dual Digital Fuzzy Controller	
Useful Block		Interchangeable Block(90×120×h60mm) for Various Tubes	
included Standard Block		None(Only Heating Block Unit)	2×48 holes×for 1.5/ 2ml Centri. Tube
Heater		Molded Heater(300W)×2ea	
Dimension(mm)		Unit : 285×250×h155, Block : (90×120×h60)×2ea	
Temp. Range, & Accuracy		Ambient +5°C to 150°C, ±0.1°C at 37°C, ±0.2°C at 90°C, ±0.4°C at 135°C	
Heat-Up Speed & Sensor		Approx. 5°C/min, PT100	
Safety Circuit		Over Temp. and Over Current Protector, Sensor Error Detector	
Timer with Alarm		99hr 59min, Alarm (Error Status and Timer - end)	
Display		Digital LCD with Back-Light Function	
Material		Unit : Stainless-steel (# 304) & Powder Coated steel, Block : Anodized Aluminum	
Included Standard Acce.		Block Tongs “BLE101” and Block Cover	
Packing Size & Gross Weight		400×270×h200 mm, 6 kg	
Power Consumption		600 W	
Electric Reqts.		1 Phase, AC 120V, 60Hz or AC 230V, 50 / 60Hz	
Cat. No.	230V	DH.WHB00198	DH.WHB00199
	120V	DH.WHB02198	DH.WHB02199
Price, Each. ₩			

* Other Specifications are available upon Customer's Request.

2-Year Warranty

Heating Block/Dry Bath, Dual Control System
 “HB-96D-set”



(3) “BLC548”



(11) “BLE101”

Included Anodized Aluminum Block & Tongs

Optional Interchangeable Anodized Aluminum Block (90×120×h60mm)

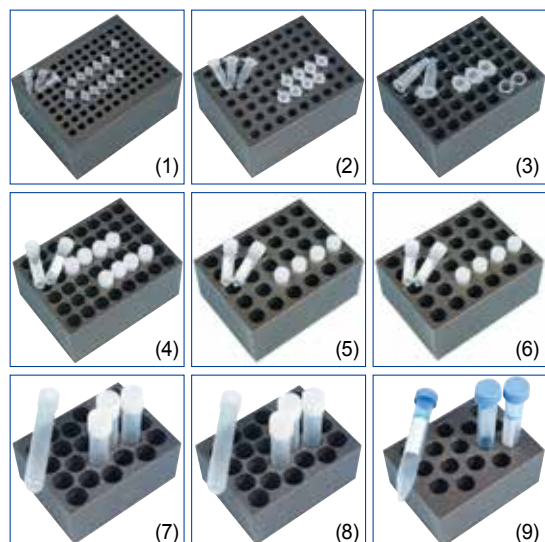

- DH.WHB510596 (1) for 0.2ml PCR Tube, (φ6×h16mm)×96 holes, “BLC596”
- DH.WHB510570 (2) for 0.5ml Centri. Tube, (φ7.7×h29.5mm)×63 holes, “BLC570”
- DH.WHB511548 (3) for 1.5/2ml Centri. Tube, (φ11×h35mm)×48 holes, “BLC548”
 (* included in the “HB-96D-Set”)
- DH.WHB521248 (4) for φ 12mm Test Tube, (φ 12×h35mm)×48 holes, “BLT248”
- DH.WHB521335 (5) for φ 13mm Test Tube, (φ 13×h47mm)×30 holes, “BLT335”
- DH.WHB521535 (6) for φ 15mm Test Tube, (φ 15×h47mm)×30 holes, “BLT535”
- DH.WHB521628 (7) for φ 16.5mm Test Tube, (φ 16.5×h47mm)×24 holes, “BLT628”
- DH.WHB521828 (8) for φ 18mm Test Tube, (φ 18×h47mm)×24 holes, “BLT828”
- DH.WHB531515 (9) for 15ml Conical Tube, (φ 16×h47mm)×15 holes, “BLC515”
- DH.WHB535008 (10) for 50ml Conical Tube, (φ 28.7×h47mm)×8 holes, “BLC008”
- DH.WHB500101 (11) Spare ; Block Extraction Tongs, “BLE101”

Ea. Price, ₩

DAIHAN® High-performance Heating Block/Dry Bath Incubator-Heating & Cooling “HB-R48”

With Digital PID Control, Acrylic Lid, Precise Temperature Control, Modular Anodized Aluminum Block, $-5^{\circ}\text{C} \sim 95^{\circ}\text{C}$, $\pm 0.1^{\circ}\text{C}$ Peltier Cooling System, Digital Timer, Interchangeable Blocks, 히팅 / 쿨링 블록, 블록 교체 가능, 아크릴 리드 / 블록용 집게 포함



- Made in Korea ■ CE Certified ■ PL (Product Liability) Insurance
- with Certificate & Traceability : Controlled by Serial Number, Certificate, Delivery-information, and Traceable Data Base System
- Designed for Multi-Function : Enzyme Reactions, Inactivation of Sera, Incubation and Other Laboratory Procedures.
- Patented Jog-Shuttle Control System and Digital LCD with Back-Light Function
- * User Self-Compensation Function to offset between Actual and Displayed Temperature. ($\pm 10.0^{\circ}\text{C}$)
- * Storage Function of Temperature and Timer setting values
- * Locking Mode Supported for Experimental Safety (Input to Jog-Shuttle can be Disabled)

Specifications & Ordering information

Spec.	Model	“HB-R48” (Only Unit)	“HB-R48-set” (included Standard Block)
Controller		Digital Fuzzy Controller	
Useful Block		Interchangeable Block(90×120×h60mm) for Various Tubes	
included Standard Block		None(Only Heating Block Unit)	48 holes×for 1.5/2ml Centri. Tube
Dimension : Unit & Block		185×230×h220mm, and 90×120×h60mm	
Cooling		Two Peltier Modules	
Cool-Down Speed		2.3°C/min. between 95°C to 25°C, 0.5°C/min. between 25°C to -5°C	
Heater and Sensor		300W (Molded Heater), PT100	
Temp. Range, & Accuracy		-5°C to 95°C , and $\pm 0.1^{\circ}\text{C}$ at 37°C , $\pm 0.2^{\circ}\text{C}$ at 90°C	
Heat-Up Speed		Approx. 5°C/min	
Safety Device		Over Temp. and Over Current Protector, Sensor Error Detector	
Timer with Alarm		99hr 59min, Alarm (Error Status and Timer - end)	
Display		Digital LCD with Back-Light Function	
Material	Internal & External	Stainless-steel (#304), and Powder Coated steel	
	Block	Anodized Aluminum	
Included Standard Acce.		Block Tongs “BLE101” and Block Cover	
Packing Size, Gross Weight		350×220×h310mm, 9 kg	
Power Consumption		450 W	
Electric Reqts.		1 Phase, AC 120V, 60Hz or AC 230V, 50 / 60Hz	

“HB-R48-Set”
with Block “BLC548” for 1.5/2ml Centrifuge Tube × 48 holes

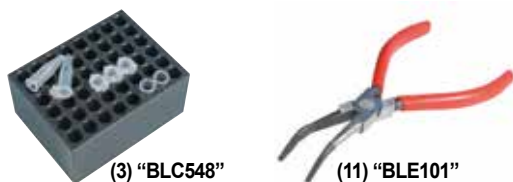

Included Anodized Aluminum Block & Tongs

Cat. No.	230V	DH.WHB00248	DH.WHB00249
	120V	DH.WHB02248	DH.WHB02249
Price, Each. ₩			

* Other Specifications are available upon Customer's Request.

Optional Interchangeable Anodized Aluminum Block (90×120×h60mm)

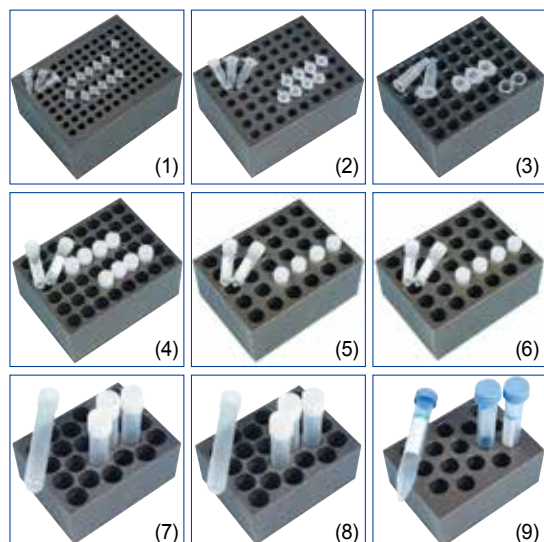

- | | |
|--------------|--|
| DH.WHB510596 | (1) for 0.2ml PCR Tube, ($\phi 6 \times h16\text{mm}$) × 96 holes, “BLC596” |
| DH.WHB510570 | (2) for 0.5ml Centri. Tube, ($\phi 7.7 \times h29.5\text{mm}$) × 63 holes, “BLC570” |
| DH.WHB511548 | (3) for 1.5/2ml Centri. Tube, ($\phi 11 \times h35\text{mm}$) × 48 holes, “BLC548”
(* included in the “HB-R48-Set”) |
| DH.WHB521248 | (4) for $\phi 12\text{mm}$ Test Tube, ($\phi 12 \times h35\text{mm}$) × 48 holes, “BLT248” |
| DH.WHB521335 | (5) for $\phi 13\text{mm}$ Test Tube, ($\phi 13 \times h47\text{mm}$) × 30 holes, “BLT335” |
| DH.WHB521535 | (6) for $\phi 15\text{mm}$ Test Tube, ($\phi 15 \times h47\text{mm}$) × 30 holes, “BLT535” |
| DH.WHB521628 | (7) for $\phi 16.5\text{mm}$ Test Tube, ($\phi 16.5 \times h47\text{mm}$) × 24 holes, “BLT628” |
| DH.WHB521828 | (8) for $\phi 18\text{mm}$ Test Tube, ($\phi 18 \times h47\text{mm}$) × 24 holes, “BLT828” |
| DH.WHB531515 | (9) for 15ml Conical Tube, ($\phi 16 \times h47\text{mm}$) × 15 holes, “BLC515” |
| DH.WHB535008 | (10) for 50ml Conical Tube, ($\phi 28.7 \times h47\text{mm}$) × 8 holes, “BLC008” |
| DH.WHB500101 | (11) Spare ; Block Extraction Tongs, “BLE101” |

Ea. Price, ₩

DAIHAN® SMART Precise Temp/Humidity Chamber “ThermoStable™ STH”, 155 · 305 · 420 · 800 Lit
 With Smart-Lab™, Auto Supplement Water Tank, Touch-Screen LCD, CFC-Free, -20°C to 100°C, up to 98% RH, 스마트 항온항습기



SMART Precise Temp. / Humidity Chamber
 “ThermoStable™ STH-155”

- Made in Korea
- PL(Product Liability) Insurance
- with Certificate & Traceability : Controlled by Serial Number, Certificate, Delivery-information, and Traceable Data Base System
- CFC Free Refrigerant (R-404A)
- Smart-Lab™ Controller : Controlled by Smart-Phone
 - Ergonomic 7" Full Touch Screen TFT LCD(Smart-Lab™ Controller)
 - WiRe™ App Service.
 - Self-Diagnostic Function
 - Push Alarm Service to Smart Phone : Power-/Temperature-/Door Open-Error Status
 - Built in USB port for Data Download and Program Upgrade
 - Password Protected Setting
 - Digital Calibration(Offset Function)
 - Door Ajar and Power Failure Alarm
 - Internet Connectivity with WiFi
 - Automatic Data Recording
 - Interactive Temperature Graph
 - Min-/Max-Temperature Memory
 - Program Function
- * Precise Temperature Control (-40°C/-20°C to 100°C) and Humidity (30% to 98% Relative Humidity)
- * Electronic Humidity Sensor has Excellent Response Time and Durability.
- * CFC-Free Refrigerant (R-404A)
- * Low Water Level Alarm System
- * The Powerful and Silent Dual Fan Motor Assures Temperature Uniformity by Strong Air Circulation (2 ~ 4pcs)
- * Large Clear Viewing Window with Membrane Heating Element (Moisture-Proof)
- * Sliding Water Supply Tank : Auto Water Supplementing System
- * Easy and Safety Door Lock
- * Over Temperature & Over Current Protection, Sensor Error Detection and Leakage Breaking
- * 6 Channels & 2 Pens Temperature & Humidity Recorder(Optional)

Specification

Spec.	Model	ThermoStable™ STH-155 Max. Capa. 155L	ThermoStable™ STH-305 Max. Capa. 305L	ThermoStable™ STH-420 Max. Capa. 420L	ThermoStable™ STH-800 Max. Capa. 800L
Temp. Range		-20°C to 100°C			
Humidity Range		30% to 98% RH			
Compressor		7/8HP	1.5HP	1.5HP	3HP
Heater	for Temp.	1.5 kW	2.0 kW	2.2 kW	2.5 kW
	for Humi.	2.0 kW	3.0 kW	3.0 kW	3.0 kW
Spec.	Model	ThermoStable™ STH-L155 Max. Capa. 155L	ThermoStable™ STH-L305 Max. Capa. 305L	ThermoStable™ STH-L420 Max. Capa. 420L	ThermoStable™ STH-L800 Max. Capa. 800L
Temp./Humidity Range		-40°C to 100°C / 30% to 98% RH			
Compressor		1.5HP	2 HP	3HP	4HP
Heater	for Temp.	1.5 kW	2.0 kW	2.2 kW	2.5 kW
	for Humi.	2.0 kW	3.0 kW	3.0 kW	3.0 kW
Dimension (w×d×h)	Interior (mm)	505×505×610	620×620×800	700×700×820	1,000×800×1,000
	Exterior (mm)	1,100×960×1,550	1,310×1,080×1,765	1,390×1,135×1,690	1,570×1,245×2,060
Capacity		155 Lit	305 Lit	420 Lit	800 Lit
Refrigerant		CFC-Free(R-404A) Refrigeration System			
Temp.	Accuracy	± 0.3°C			
	Stability	± 0.3°C			
Humidity	Accuracy	± 0.3% RH			
	Stability	± 0.3% RH at 70%			
Heat-up Time		35 min (-20°C to 80°C)			
Cool-down Time		45 min (+20°C to -20°C)			
Controller & Display		Smart-Lab Controller, 7" Full Touch Screen TFT LCD			
Program Function		Multiple Programs(Patterns by multiple Segments) Supported			
Sensor		PT100 & Capacitive Sensor			
Material	Internal	Stainless-steel (# 304)			
	External	Powder Coated steel			
Shelf		3ea of Perforated Stainless-steel Shelf of Adjustable Position			
Safety Device		Over Temp. and Over Current Protector, Sensor Error and Low Level Detector, Leakage Breaker			
Packing Dimension (w×d×h) (cm)		134 × 116 × 175	152 × 125 × 207	160 × 130 × 202	178 × 141 × 237
Gross Weight		353 kg	369 kg	478 kg	678 kg
	Power Consumption	4.7 kW	5.7 kW	6.3 kW	9 kW
Electric Reqts.		6.2 kW	7.9 kW	9.9 kW	12.7 kW
		1 Phase AC 120V, 60Hz or AC 230V, 50/60Hz or 3 Phase			

* Other Specifications are available upon Customer's Request. ※ 운임 약 ₩ 95,000 별도!

※ -40~100°C Upgrade Model
 Coming Soon!

<Continued On Next Page>

Cat. No	Description	Articles
---------	-------------	----------

<Continued From... DAIHAN® SMART Precise Temp/Humidity Chamber, "ThermoStable™ STH">

Ordering Information

※ 운임 약 ₩ 70,000 별도!

(1) Programmable Temp./Humidity Chamber, 1 Phase

DH.STH01155	Temp. / Humidity Chamber, "STH-155", -20℃ to 100℃, 155 Lit, 230V
DH.STH01305	, "STH-305", -20℃ to 100℃, 305 Lit, 230V
DH.STH01420	, "STH-420", -20℃ to 100℃, 420 Lit, 230V
DH.STH01800	, "STH-800", -20℃ to 100℃, 800 Lit, 230V
DH.STH02155	Temp. / Humidity Chamber, "STH-L155", -40℃ to 100℃, 155Lit, 230V
DH.STH02305	, "STH-L305", -40℃ to 100℃, 305Lit, 230V
DH.STH02420	, "STH-L420", -40℃ to 100℃, 420Lit, 230V
DH.STH02800	, "STH-L800", -40℃ to 100℃, 800Lit, 230V
DH.STH05155	Temp. / Humidity Chamber, "STH-155", Same as Above, but only 120V
DH.STH05305	, "STH-305", Same as Above, but only 120V
DH.STH05420	, "STH-420", Same as Above, but only 120V
DH.STH05800	, "STH-800", Same as Above, but only 120V
DH.STH06155	Temp. / Humidity Chamber, "STH-L155", Same as Above, but only 120V
DH.STH06305	, "STH-L305", Same as Above, but only 120V
DH.STH06420	, "STH-L420", Same as Above, but only 120V
DH.STH06800	, "STH-L800", Same as Above, but only 120V

Ea. Price, ₩

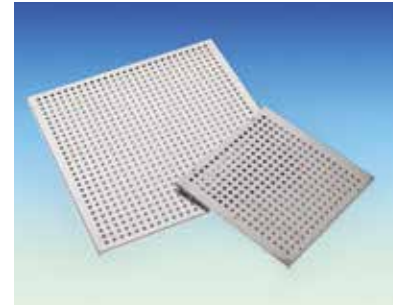

Perforated Stainless-steel Shelf (Included)



Auto Water Supplementing System

(2) Programmable Temp./Humidity Chamber, 3Phase, for Customizing

DH.STH07155	Temp. / Humidity Chamber, "STH-155", -20℃ to 100℃, 155 Lit
DH.STH07305	, "STH-305", -20℃ to 100℃, 305 Lit
DH.STH07420	, "STH-420", -20℃ to 100℃, 420 Lit
DH.STH07800	, "STH-800", -20℃ to 100℃, 800 Lit
DH.STH08155	Temp. / Humidity Chamber, "STH-L155", -40℃ to 100℃, 155Lit
DH.STH08305	, "STH-L305", -40℃ to 100℃, 305Lit
DH.STH08420	, "STH-L420", -40℃ to 100℃, 420Lit
DH.STH08800	, "STH-L800", -40℃ to 100℃, 800Lit

Ea. Price, ₩

Spare Perforated Stainless-steel Shelf

DH.WTH11155	Perforated Shelf, Stainless-steel, "THS1155", for 155 Lit, w470×d480mm
DH.WTH11305	, "THS1305", for 305 Lit, w590×d580mm
DH.WTH11420	, "THS1420", for 420 Lit, w720×d640mm
DH.WTH11800	, "THS1800", for 800 Lit, w970×d980mm

Ea. Price, ₩

Optional Temp & Humidity Recorder and Chart Paper

DH.WTH05100	Temperature & Humidity Recorder, "WTH5100"
DH.WTH05105	Chart Paper, "WTH5105", 33 Days

Ea. Price, ₩



Temp. & Humidity Recorder 6 Channel 2 Pens(WTH5100) (Optional)

Programmable Temp./Humidity Chamber with Validation (IQ, OQ) Service

DH.STH31155	Validation Service(IQ, OQ), with "STH-155", "STHV1155"
DH.STH31305	, with "STH-305", "STHV1305"
DH.STH31420	, with "STH-420", "STHV1420"
DH.STH31800	, with "STH-800", "STHV1800"
DH.STH32155	Validation Service(IQ, OQ), with "STH-L155", "STHV2155"
DH.STH32305	, with "STH-L305", "STHV2305"
DH.STH32420	, with "STH-L420", "STHV2420"
DH.STH32800	, with "STH-L800", "STHV2800"

Ea. Price, ₩

» DAIHAN WiRe™ App Service



7" Full Touch Screen TFT LCD (Smart-Lab™ Controller)



WiRe™ App Service

It is possible to monitor and control the Smart-Lab™ equipment through all smart phone, tablet without restraint of time and place.

Controlled by Smart-Phone

DAIHAN® General Purpose SMART Temp/Humidity Chamber “ThermoStable™ STH-E”, 155 · 305 · 420 · 800 Lit
With Smart-Lab™ System, Water Tank, Touch-Screen LCD, CFC-Free, -20°C~80°C ±0.3 °C, up to 95% RH, 스마트 항온항습기



2-Year Warranty

SMART Temp./Humidity Chamber “ThermoStable™ STH-E”

- Made in Korea
- PL(Product Liability) Insurance
- with Certificate & Traceability : Controlled by Serial Number, Certificate, Delivery-information, and Traceable Data Base System
- Economical & Practical Type
- CFC Free Refrigerant (R-404A)
- Smart-Lab™ Controller : Remote Controlled by Smart-Phone with WiRe™ App Service
 - Ergonomic 7" Full Touch Screen TFT LCD
 - Internet Connectivity with WiFi
 - RS232 Interface for Remote Monitoring and Controlling with PC
 - Built in USB port for Data Download and Program Upgrade
 - Password Protected Setting
 - Variable Program Setting for Multiple Patterns with Multiple Segments
 - Self-Diagnostic Function (Push Alarm to Smart Phone) : Door Ajar and Power-/Temp.-Failure Alarm
 - Min-/Max-Temperature Memory and Automatic Data Recording
 - Interactive Temperature Graph
 - Digital Calibration (Offset Function)
- * The Powerful and Silent Dual Fan Motor Assures Temperature Uniformity by Strong Air Circulation
- * Over Temperature and Over Current Protection for User Safety
- * Inner Tempered Glass Door with Silicon Packing
- * Low Water Level Alarm Lamp
- * Temperature & Humidity Recorder (6 Channels & 2Pens) (Optional)

Specifications & Ordering information

※ 운임 약 ₩ 70,000 별도!

Spec.	Model	ThermoStable™ STH-E155	ThermoStable™ STH-E305	ThermoStable™ STH-E420	ThermoStable™ STH-E800
		Max. Capa. 155L	Max. Capa. 305L	Max. Capa. 420L	Max. Capa. 800L
Capacity		155 Lit	305 Lit	420 Lit	800 Lit
Temp.	Range	PT100 Sensor, -20°C ~ +80°C			
	Accuracy	±0.3°C (Stability ±1.0 °C)			
Humidity	Range	30% ~ 95% RH			
	Accuracy	±2% (Stability ±3% RH)			
Dimension (w×d×h)	Interior (mm)	505×505×610	620×620×800	750×660×850	1000×800×1000
	Exterior (mm)	745×920×1645	820×1290×1720	990×1075×1885	1200×1100×1920
Heater	for Temp.	1.5 kW	2.0 kW	2.2 kW	2.5 kW
	for Humi.	2.0 kW	3.0 kW	3.0 kW	3.0 kW
Compressor		7/8HP	1.5 HP	1.5 HP	3 HP
Refrigerant		CFC-Free(R-404A) Refrigeration System			
Controller & Display		Smart-Lab Controller, 7" Full Touch Screen TFT LCD			
Program Function		Multiple Programs(Patterns by multiple Segments) Supported			
Material		Internal : Stainless-steel(# 304), External : Powder Coated steel			
Shelf (included)		3ea of Perforated Stainless-steel Shelf of Adjustable Position			
Safety Device		Hi-Low Temp. Protector, Over Current & Leakage Breaker, Water Level Sensor			
Others		PL(Product Liability) Insurance			
Packing Dimension (w×d×h) (cm)		99×112×185	122×122×205	128×128×216	149×132×220
Net & Gross Weight, kg		290 kg, 355 kg	309 kg, 369 kg	378 kg, 478 kg	558 kg, 678 kg
Power Consumption		4.4 kW	5.7 kW	6.3 kW	8.2 kW
Electric Reqts.		1 Phase AC 120V, 60Hz or AC 230V, 50/60Hz or 3 Phase			
Cat. No.	230V	DH.STHE0155	DH.STHE0305	DH.STHE0420	DH.STHE0800
	120V	DH.STHE4155	DH.STHE4305	DH.STHE4420	DH.STHE4800
	3Phase	DH.STHE5155	DH.STHE5305	DH.STHE5420	DH.STHE5800
Price, Each. ₩					

DAIHAN WiRe™ App Service



It is possible to monitor and control the Smart-Lab™ equipment through all smart phone, tablet without restraint of time and place.

7" Full Touch Screen TFT LCD (Smart-Lab™ Controller)

Controlled by Smart-Phone

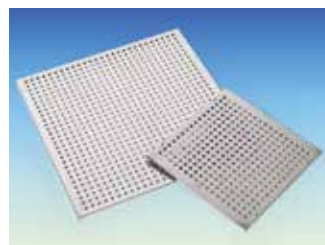

(1) Perforated Stainless-steel Shelf (Included)



(2) Temp. & Humidity Recorder 6 Channel 2 Pens (WTH5100) (Optional)

Validation (IQ, OQ) Service Economic Temp./Humidity Chamber

Model	Validation Service(IQ, OQ), with	Ea. Price, ₩
DH.STHE3155	Validation Service(IQ, OQ), with "STH-E155", "STHEV155"	
DH.STHE3305	, with "STH-E305", "STHEV305"	
DH.STHE3420	, with "STH-E420", "STHEV420"	
DH.STHE3800	, with "STH-E800", "STHEV800"	

Spare Perforated Stainless-steel Shelf

Model	Description	Ea. Price, ₩
DH.WTH11155	(1) Perforated Shelf, "THS1155", for 155 Lit, 470×480mm	
DH.WTH11305	, "THS1305", for 305 Lit, 590×580mm	
DH.WTH11420	, "THS1420", for 420 Lit, 720×640mm	
DH.WTH11800	, "THS1800", for 800 Lit, 970×980mm	

Optional Temp & Humidity Recorder and Chart Paper

Model	Description	Ea. Price, ₩
DH.WTH05100	(2) Temperature & Humidity Recorder, "WTH5100"	
DH.WTH05105	Chart Paper, "WTH5105", 33 Days	

DAIHAN® SMART Low Temperature(B.O.D) Incubator “ThermoStable™ SIR”, 150 · 250 · 420 · 700 Lit
 With Smart-Lab™ Controller, 4” Full Touch Screen, Fuzzy-PID Control, CFC-free(R-404A), 0~60℃, ±0.2℃, with Certi. & Traceability
 스마트 저온(B.O.D) 배양기/인큐베이터, 강제 순환식, 우수한 온도정확성, 친환경 냉매 채용, WiRe™서비스, 4인치 풀터치스크린 조절기



SMART Low Temperature(B.O.D) Incubator
 “ThermoStable™ SIR-150”

- Made in Korea
- CE Certified
- with Certificate & Traceability : Controlled by Serial Number, Certificate, Delivery-information, and Traceable Data Base System
- Air Flow ; Forced Air-type
- Digital Fuzzy Control System Implementing Superior Temperature Accuracy
- Smart-Lab™ Controller : Remote Controlled by Smart-Phone with WiRe™ App Service
 - Ergonomic 4” Full Touch Screen TFT LCD
 - Internet Connectivity with WiFi
 - RS232 Interface for Remote Monitoring and Controlling with PC
 - Automatic Data Recording
 - Built in USB port for Data Download and Program Upgrade
 - Self-Diagnostic Function
 - Variable Program Setting for Multiple Patterns with Multiple Segments
- * Variable Application : Animal/Plant Cell Culture, Constant Temp. Germination Test, BOD Test, etc.
- * Stainless-steel Chamber and PE-coated Shelves
- * Compact New Body Design
- * Intelligent Control of Refrigerator for Preventing Overload of Compressor
- * Over Temperature & Over Current Protection, Sensor Error Detection and Leakage Breaking.

Specifications & Ordering information

※ 운임 약 ₩ 50,000 별도!

Spec.	Model	ThermoStable™ SIR-150 Max. Capa. 155L	ThermoStable™ SIR-250 Max. Capa. 250L	ThermoStable™ SIR-420 Max. Capa. 420L	ThermoStable™ SIR-700 Max. Capa. 700L
Capacity		150 Lit	250 Lit	420 Lit	700 Lit
Temp. Range & Accuracy		0℃ ~ 60℃, ± 0.2℃ at 37℃			
Temp. Uniformity & Sensor		±0.5℃ at 37℃, ±1.4℃ at 50℃, PT100 Sensor			
Heat-up Time		20 min. to 37℃ 20 min. to 50℃		35 min. to 37℃ 35 min. to 50℃	
Recovery Time (Door open 30sec)		10 min. to 37℃ 12 min. to 50℃		12 min. to 37℃ 15 min. to 50℃	
Heating Power/Consumption		700 W	1 kW	1.2 kW	2 kW
Compressor		1/4HP	1/3HP	1/2HP	1/2HP
Compressor Control		Intelligent Control of Refrigerator for preventing Overload of Compressor			
Refrigerant		CFC-Free(R-404A) Refrigeration System			
Timer & Alarm		99hr 59min (with delay / Continuous run.), Error status & Timer-end			
Display & Controller		4”Full Touch Screen TFT LCD, Smart-Lab™ Controller			
Inner Door		with 1ea of Inner Tempered Glass Door			
Shelf		Included 3ea of PE-coated steel Shelf			
Permitted		Total Load Total Load : 48 kg (16kg × 3 Shelf)			
Safety Circuit		Over Temp. and Over Current Protector, Sensor Error Detector			
Material		Internal : Stainless-steel (# 304), External : Powder Coated steel			
Dimension (w×d×h)	Interior (mm)	505×505×610	505×505×1,000	705×605×1,000	800×700×1,250
	Exterior (mm)	640×832×1,313	640×832×1,703	840×932×1,753	935×1,027×2,000
Net Weight / Gross Weight		118 kg / 191 kg	157 kg / 217 kg	202 kg / 277 kg	234 kg / 313 kg
Packing Size (w×d×h) (mm)		900×1,000×1,650	900×1,000×2,040	1,100×1,100×2,140	1,220×1,220×2,260
Power Consumption		1.6 kW	1.8 kW	2.3 kW	2.4 kW
Electric Reqts.		1 Phase, AC 120 V, 60 Hz or AC 230 V, 50 / 60 Hz			
Cat. No.	230V	DH.SWIR03150	DH.SWIR03250	DH.SWIR03420	DH.SWIR03700
	120V	DH.SWIR04150	DH.SWIR04250	DH.SWIR04420	DH.SWIR04700
Price, Each. ₩					

» DAIHAN WiRe™ App Service



It is possible to monitor and control the Smart-Lab™ equipment through all smart phone, tablet without restraint of time and place.

4” Full Touch Screen TFT LCD (Smart-Lab™ Controller)

Controlled by Smart-Phone



(1) Wire Shelf
 PE Coated steel
 (Included)

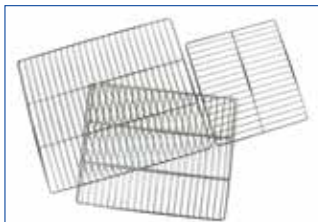

(2) Wire Shelf
 Stainless-steel
 (Optional)

Validation (IQ, OQ) Service Low Temp(B.O.D) Incubator

	Ea. Price, ₩
DH.SWIR31150 Validation Service(IQ, OQ), with “ThermoStable SIR-150”, “SIRV150”	
DH.SWIR31250 , with “ThermoStable SIR-250”, “SIRV250”	
DH.SWIR31420 , with “ThermoStable SIR-420”, “SIRV420”	
DH.SWIR31700 , with “ThermoStable SIR-700”, “SIRV700”	

Spare PE-coated Steel Wire Shelf

	Ea. Price, ₩
DH.WIR11150 (1) Wire Shelf, “IRS150”, 470×480mm, for “SIR-150”, “SIR-250”	
DH.WIR11420 , “IRS420”, 675×585mm, for “SIR-420”	
DH.WIR11700 , “IRS700”, 770×680mm, for “SIR-700”	

Optional Stainless-steel Wire Shelf

	Ea. Price, ₩
DH.WIR21150 (2) Wire Shelf, “IRU150”, 470×480mm, for “SIR-150”, “SIR-250”	
DH.WIR21420 , “IRU420”, 675×585mm, for “SIR-420”	
DH.WIR21700 , “IRU700”, 770×680mm, for “SIR-700”	

DAIHAN® Low Temperature(B.O.D) Incubator “ThermoStable™ IR”, Class-I Medical Device(NIDS), 0~60°C, ±0.2°C
 With 3 Wire Shelf, Digital PID Control, CFC-free Refrigeration(R-404A) System, Forced-air, 150 · 250 · 420 · 700 Lit
 저온(B.O.D) 배양기/인큐베이터, 강제 순환식, 우수한 온도정확성, 친환경 냉매 채용



Low Temperature(B.O.D) Incubator
 “ThermoStable™ IR-150”



WiseRemote Control Software :

Connection of Temperature Devices
 with Interface RS232C to a PC
 Export Recorded Data(Excel Spreadsheet)

* You can Download this Software from
 DAIHAN-Sci.com Shopping-mall

- Made in Korea ■ UL / CUL Certified ■ CE Certified
 - with Certificate & Traceability : Controlled by Serial Number,
 Certificate, Delivery-information, and Traceable Data Base System
 - Intelligent Control of Refrigerator for Preventing Overload of Compressor
 - CFC-free (R-404A) Refrigeration System
 - Digital PID Control System Implementing Superior Temperature Accuracy
 - Patented Jog-Dial Control System ■ PL(Product Liability) Insurance
- * Variable Application : Animal & Plant Cell Culture, Constant Temperature, Germination Test, BOD Test, and so on
 * RS232C Interface for Monitoring and Controlling with PC
 * Superior Temperature Uniformity by Forced-air
 * Stainless-steel Chamber and PE-coated Shelves
 * Over Temperature & Over Current Protection, Sensor Error Detection and Leakage Breaking.
 * Storage Function : Alarm & Timer * Back-Light LCD
 * Locking Mode Supported for Experimental Safety (Input to Jog -Dial can be Disabled)
 * CFC-free (R-404A) Refrigeration System. * Compact New Body Design

Specifications & Ordering information

Spec.	Model	ThermoStable™ IR-150	ThermoStable™ IR-250	ThermoStable™ IR-420	ThermoStable™ IR-700
		Max. Capa. 150L	Max. Capa. 250L	Max. Capa. 420L	Max. Capa. 700L
Capacity		150 Lit	250 Lit	420 Lit	700 Lit
Air Flow-type		Forced-air Type			
Temp. Range & Accuracy		0°C ~ 60°C, ± 0.2°C at 37°C			
Temp. Uniformity & Sensor		± 0.5°C at 37°C, ± 1.4°C at 50°C, PT100 Sensor			
Heat-up Time		20 min. to 37°C 20 min. to 50°C		35 min. to 37°C 35 min. to 50°C	
Recovery Time (Door open 30sec)		10 min. to 37°C 12 min. to 50°C		12 min. to 37°C 15 min. to 50°C	
Heating Power/Consumption		700 W	1 kW	1.2 kW	2 kW
Compressor		1/4HP	1/3HP	1/2HP	1/2HP
Compressor Control		Intelligent Control of Refrigerator for preventing Overload of Compressor			
Refrigerant		CFC-Free(R-404A) Refrigeration System			
Timer & Alarm		99hr 59min (with delay / Continuous run.), Error status & Timer-end			
Display		Digital LCD with Back Light			
Controller		Digital PID Controller with Jog-Shuttle Switch (Turn & Push)			
Inner Door		with 1ea of Inner Tempered Glass Door			
Shelf		Included 3ea of PE-coated steel Shelf			
Permitted Total Load		Total Load : 48 kg (16kg×3 Shelf)			
Safety Circuit		Over Temp. and Over Current Protector, Sensor Error Detector			
Material		Internal : Stainless-steel (# 304), External : Powder Coated steel			
Dimension (w×d×h)	Interior (mm)	505×505×610	505×505×1,000	705×605×1,000	800×700×1,250
	Exterior (mm)	640×832×1,313	640×832×1,703	840×932×1,753	935×1,027×2,000
Net Weight		118 kg	157 kg	202 kg	234 kg
Packing Size (w×d×h) (mm) & Gross Weight		900×1,000×1,650	900×1,000×2,040	1,100×1,100×2,140	1,220×1,220×2,260
		191 kg	217 kg	277 kg	313 kg
Power Consumption		1.6 kW	1.8 kW	2.3 kW	2.4 kW
Electric Reqts.		1 Phase, AC 120 V, 60 Hz or AC 230 V, 50 / 60 Hz			
Cat. No.	230V	DH.WIR03150	DH.WIR03250	DH.WIR03420	DH.WIR03700
	120V	DH.WIR04150	DH.WIR04250	DH.WIR04420	DH.WIR04700
Price, Each. ₩					

* Other Specifications are available upon Customer's Request.

※ 운임 약 ₩ 50,000 별도!

Cat. No	Description	Articles
---------	-------------	----------

<Continued From... DAIHAN® Low Temperature(B.O.D) Incubator “ThermoStable™ IR”>

Spare PE-coated Steel Wire Shelf

- DH.WIR11150 Wire Shelf, PE Coated steel, “IRS150”, w470×d480mm, for “IR-150”, “IR-250”
- DH.WIR11420 Wire Shelf, PE Coated steel, “IRS420”, w675×d585mm, for “IR-420”
- DH.WIR11700 , “IRS700”, w770×d680mm, for “IR-700”

Ea. Price, ₩

Optional Stainless-steel Wire Shelf

- DH.WIR21150 (1) Wire Shelf, Stainless-steel, “IRU150”, w470×d480mm, for “IR-150”, “IR-250”
- DH.WIR21420 (1) Wire Shelf, Stainless-steel, “IRU420”, w675×d585mm, for “IR-420”
- DH.WIR21700 , “IRU700”, w770×d680mm, for “IR-700”

Ea. Price, ₩

Low Temp(B.O.D) Incubator with Validation (IQ, OQ) Service

- DH.WIR31150 Validation Service(IQ, OQ), with “ThermoStable IR-150”, “IRV150”
- DH.WIR31250 , with “ThermoStable IR-250”, “IRV250”
- DH.WIR31420 , with “ThermoStable IR-420”, “IRV420”
- DH.WIR31700 , with “ThermoStable IR-700”, “IRV700”

Ea. Price, ₩



Low Temperature(B.O.D) Incubator “ThermoStable IR-150”

» New Jog-Dial Controller

⑤ Digital LCD with Back-light Function

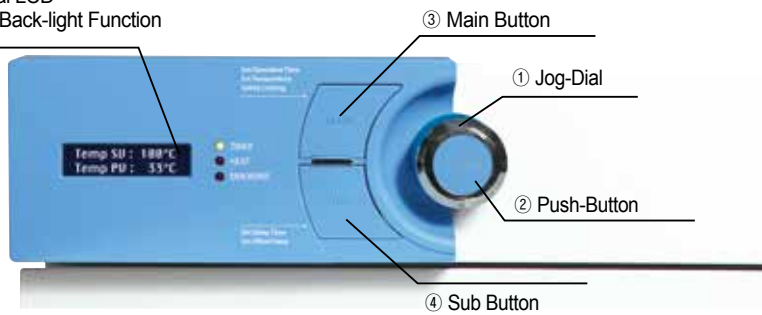

- Provides the user interface with an ergonomic design for users to operate in an easy and convenient way.
- A new 2-way Jog-Dial Knob (Jog Dial + Push Button) and presents excellent durability and mobility.
- High-quality LCD with Back-light function.
- A durable Main Button and a Sub Button that features superb and user-friendly operation.



Wire Shelf, PE Coated steel (Included)

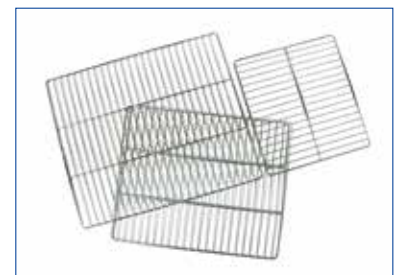

(1) Wire Shelf, Stainless-steel (Optional)

DAIHAN® SMART Plant Growth Chamber “ThermoStable™ GC”, Smart-Lab™ System, 432 · 864 Lit
 With Smart-Lab™ Controller, CFC-Free, 0~12,000- or 15,000-Lux, 30~95% RH, 10~60℃, with Certi. & Traceability
 스마트 식물 생산상, 스마트랩 컨트롤러, 정밀한 온도/습도/조도 조절, WiRe™서비스, 7인치 풀터치스크린 스마트랩 조절기



(1) SMART Plant Growth Chamber “ThermoStable™ GC-450”

- Made in Korea ■ CE Certified ■ PL(Product Liability) Insurance
- with Certificate & Traceability : Controlled by Serial Number, Certificate, Delivery-information, and Traceable Data Base System
- Suitable for Plant Growth, Stability, Product Self-life QC Testing
- Ergonomic Screen Design 7" Full Touch Screen TFT LCD (Smart-Lab™ Controller) : Controlled by Smart-Phone
- WiRe™ App Service. ■ Automatic Data Recording
- Self-Diagnostic Function
- Variable Program Setting for Multiple Patterns with Multiple Segments
- The Recorded Data could be transferred to PC by USB memory
- Controller SW can be upgraded through USB port.
- * Inner Tempered Glass Door with Silicone Packing offers easy Observation without Door Opening
- * Humidity Control by Capacitive Humidity Sensor provides Accurate Control from 30 to 95%RH
- * Smart-Lab™ Controller Provides Precise Temperature, Relative Humidity and Illumination Control - Maintain Uniformity and Accuracy of Growth Circumstance
- * 3-/4- Side Light Bank System : Intensity of Light is controlled by 8-levels and Displayed on LCD
- * Over Temperature & Over Current Protection, Sensor Error Detection, Leakage Breaking

Specification

Spec.	Model	(1) “ThermoStable™ GC-450” Max. Capa. 432 Lit	(2) “ThermoStable™ GC-1000” Max. Capa. 864 Lit
Capacity		432 Lit	864 Lit
Temp.	Range & Variation	10℃ ~ 60℃, ±1℃ at 20℃	
	Fluctuation	± 0.5℃ at 10℃, ± 0.5℃ at 25℃ (0% light intensity) ± 1℃ at 10℃, ± 1℃ at 25℃ (100% light intensity)	
Humidity	Range & Variation	30% ~ 95% RH, ±3% at 60℃	
	Fluctuation	±1%	
	Humidifier	Evaporation by Fan with Heater	
Illumination	Range	0 to 12,000 Lux	0 to 15,000 Lux
	Lamp	FPL 55W×14	FPL 55W×28
	Bank	3 Side Walls	
Temp. & Humidity Sensor	Temp. : PT100, Humidity : Capacitive Sensor		
Heat-up Time (up to 37℃)	11 min. (0 % illumination) / 9 min. (100 % illumination)		
Cool-down Time (down to 10℃)	13 min. (0 % illumination) / 15 min. (100 % illumination)		
Temp. Recovery (After Door was opened for 30sec)	3 min. at 10℃, 1 min. at 37℃ (0 % illumination)		
	5 min. at 10℃, 1min. at 37℃ (100 % illumination)		
Heating Power /Consumption	for Temp.	1.5 kW	3.0 kW
	for Humi.	1.5 kW	3.0 kW
Compressor	1/2HP		
Refrigerant	CFC-Free(R-404A) Refrigeration System		
Display	7" Full Touch Screen TFT LCD (Smart-Lab™ Controller)		
Controller	Smart-Lab™ Controller		
Program Function	Temperature and Humidity : 120 Patterns, 1,200 Segments Light Bank : 7 steps		
Door	Internal	Tempered Safety Glass with Silicon Packing	
	External	3-Side Magnetic Packing Door with Light Bank	
Shelf	4× PE-coated Steel Shelf	8× PE-coated Steel Shelf	
Permitted Total Load	64 kg (16kg×4 Shelves)	128 kg (16kg×8 Shelves)	
Safety Circuit	Over Temp Protector, Over Current & Leakage Breaker		
Material	Internal : Stainless-steel (# 304), External : Power Coated steel		
Dimension (w×d×h)	Interior (mm)	650×700×1,050	1,200×790×1,050
	Exterior (mm)	850×1,090×1,965	1,400×1,150×1,965
Packing Size & Gross Weight	1,400×1,220×h2,210mm, 435 kg	1,600×1,500×h2,200mm, 585 kg	
Power Consumption	4.8 kW		
Power Supply*	1 Phase AC 120V, 60Hz or AC 230V, 50/60Hz or 3 Phase		

* Other Specifications are available upon Customer's Request.



Main Display of Smart-Lab™ Controller



Graph Display of Smart-Lab™ Controller



Program Set Display of Smart-Lab™ Controller

<Continued On Next Page>

Cat. No	Description	Articles
---------	-------------	----------

<Continued From...DAIHAN® SMART Plant Growth Chamber “ThermoStable™ GC”>

Ordering Information

※ 운임 약 ₩ 90,000 별도!

(1) 432 Lit Plant Growth Chamber “ThermoStable™ GC-450”, 0~12,000 Lux

- DH.SWGC00450* Plant Growth Chamber, 230V, “ThermoStable GC-450”
- DH.SWGC50450* , 120V, “ThermoStable GC-450”
- DH.SWGC60450* , 3 Phase, “ThermoStable GC-450”

Ea. Price, ₩

(2) 864 Lit Plant Growth Chamber “ThermoStable™ GC-1000”, 0~15,000 Lux

- DH.SWGC01000* Plant Growth Chamber, 230V, “ThermoStable GC-1000”
- DH.SWGC61000* , 3 Phase, “ThermoStable GC-1000”

Ea. Price, ₩

*-marks : Included Water Tank(with Silicon Tube) and Lux Meter

Spare Wire Shelf, PE Coated steel

- DH.WGC10450 Wire Shelf, PE Coated, w640×d620mm, “GCS450”, for 432Lit
- DH.WGC11000 , w580×d620mm, “GCS1000”, for 864Lit

Ea. Price, ₩

Validation (IQ, OQ) Service

- DH.SWGC30450 Validation Service(IQ, OQ), with “ThermoStable GC-450”, “SGCV450”
- DH.SWGC31000 , with “ThermoStable GC-1000”, “SGCV1000”

Ea. Price, ₩



2-Year Warranty

(1) SMART Plant Growth Chamber “ThermoStable™ GC-450”

» DAIHAN WiRe™ App Service



7" Full Touch Screen TFT LCD (Smart-Lab™ Controller)

It is possible to monitor and control the Smart-Lab™ equipment through all smart phone, tablet without restraint of time and place.



WiRe™ App Service

Controlled by Smart-Phone



Wire Shelf, PE-coated steel (Included)



Water Tank/Silicon Tube/Lux Meter (Included)

DAIHAN® 4~45°C & 0~10% CO₂ 20Lit Mini CO₂ Incubator & CO₂ Shaking Incubator, "ThermoStable™ IC-20 & ICS-20"
 Programmable PID Controlled 0.1°C & 0.1%, Compact Design for Saving Space/Money, Ideal for Cell/Tissue Culture **NEW**
 With Cooling/Heating system of Peltier Element/Auto-Tuning/Safety Device, **저온 미니 CO₂ 배양기 & CO₂ 진탕 배양기**



A. 20Lit Mini CO₂ Incubator "ThermoStable™ IC-20"
 Including CO₂ Gas Cylinder & Regulator

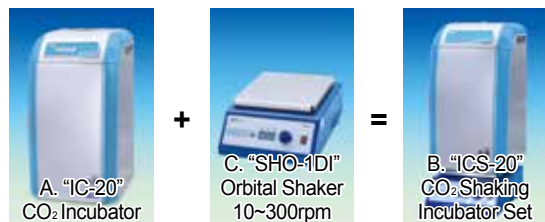
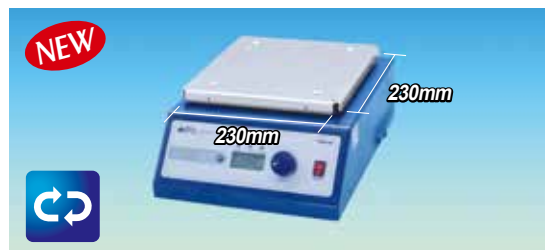

Figure: Assembly CO₂ Shaking Incubator
 You can easily connect the Incubator & Shaker



B. "ICS-20" CO₂ Shaking Incubator Set



C. "SHO-1DI" Separable Orbital Shaker
 ; It can be Used Individually and Be Accepted

- A. Standard CO₂ Incubator "ThermoStable™ IC-20"**
 Including CO₂ Regulator & CO₂ Aluminum Cylinder
- B. Assembly CO₂ Shaking Incubator Package Set "ThermoStable™ ICS-20"**
 = Standard CO₂ Incubator "IC-20" + Orbital Shaker "SHO-1DI"
- C. Multiuse Digital Orbital Motion Shaker "SHO-1DI" : Can Be Used Individually.**
 "SHO-1DI" is same with existing Orbital Shaker "SHO-1D" except Platform, and can be Accepted
 Optional Various Platforms ; See the Shaker Section
- Made in Korea ■ PL(Product Liability) Insurance ■ 2-Year Warranty
 - Applications : Cell/Tissue Culture & Transfer, Embryo/Microorganism Culture
 - NDIR CO₂ Sensor : Dual Wavelength Type
 Rapid Initial Response Time, not Affected by User Environment
 - ABS-Resin Chamber & Housing : Light-weight/Compact Design
 Good for Money & Space Saving and Personal Use.
 - Certificate & Traceability : Controlled by Serial Number, Certificate, Delivery-Information, and Traceable Data Base System.
- * Cooling/Heating System of PELTIER ELEMENT :
 - Cooling and Heating by using Thermoelectric Semiconductor Element
 - Minimizes Noise(<20dB) and Power Consumption
- * Auto-Tuning : Rapid Response and High Stability According to the Thermal Properties and the Rate of Thermal Response of the Object
- * Safety Device : Over Temperature & Over Current Protection, Sensor Error Detection
- * 4-Connection Device to Join a Shaker "SHO-1DI" in the Bottom outside of the CO₂ Incubator "IC-20"

Specifications & Ordering Information

Spec.	Model	A. CO ₂ Standard Incubator "ThermoStable™ IC-20"	B. CO ₂ Shaking Incubator Set "ThermoStable™ ICS-20"
Capacity (Lit)		20Lit Working Chamber	
Temp. Range		4 ~ 45°C, 0.1°C; Digital PID Control	
Accuracy		± 0.2°C (No Load)	
Uniformity		± 0.2°C (at 37°C)	
CO ₂ Range & Control		0 ~ 10%, 0.1% ; NDIR CO ₂ Sensor	
Cooling/Heating		Peltier Element Module	
Air Flow-type		Gravity Flow Circulation	
1 Shelf and 3 Location Brackets		1 Perforated ABS Shelf(w210×d230×Thick 8mm) included Adjustable Shelf Location Height of 3-Stage	
Condensate Drain		Natural Evaporation	
Incubator Material		"ABS-Resin" Chamber & Housing, Except Shaking Base	
Incubator Dimension	Interior	w213×d265×h360mm Chamber Only	
	Exterior	w280×d330×h510mm	w280×d330×h670mm; Including Shaking Base
C. SHAKING-Base; Connecting the Multiuse Shaking "SHO-1DI"			
- Motion & Speed			- Orbital, 10 ~ 300rpm, 8mm Stroke
- Controller & Display			- Programmable Digital Feedback, LCD
- Timer & Alarm			- 99hr 59min with ∞ Run, Error Status & Time End
- Motor & Max-Load			- Brushless DC Motor, Max-Load 10kg
- Safety Circuit			- Overload Protector of Motor
- Material			- Powder Coated Steel Body
- Size & Weight			- w260×d330×h140mm, 14kg
Net Weight (kg)	10kg		10kg+14kg Shaking Base ("SHO-1DI") = 24kg
Power Consumption	56W		56W+40W (Shaking)
Electric Reqts.		Free Voltage; 1Phase, AC90-240V, 50/60Hz	
Cat. No.	230V	DH.IncC020	DH.IncCS020
	120V	DH.IncC020.1	DH.IncCS020.1
Price, Set. ₩			

C. SHAKING-Base; Orbital Shaker

DH.SHO01DI Shaker "SHO-1DI", 230V
 DH.SHO01DI.1 , 120V

Ea. Price, ₩

※ Note! Details of Optional Various Platforms : See The "Shaker" Section

DAIHAN® 4~45°C 20 Lit Mini-Low Temperature Incubator & Shaking Incubator, "ThermoStable™ IR-20 & IRS-20" NEW
 2-Step Programmable PID Controlled 0.1°C, Compact Design for Saving Space/Money, Ideal for Culture & Storage of Microorganism/Clone
 With Cooling/Heating system of Peltier Element/Auto-Tuning/Safety Device, **저온 미니-배양기&진탕 배양기, 20Lit, 4~45°C/0.1°C**



A. 20Lit Mini-Low Temp Incubator "ThermoStable™ IR-20"

A. Standard Incubator "ThermoStable™ IR-20"

B. Assembly Shaking Incubator Package Set

"ThermoStable™ IRS-20" = "IR-20" Incubator + Orbital Shaker "SHO-1DI"

C. Multiuse Digital Orbital Motion Shaker "SHO-1DI" : Can be Used Individually.

It is same with existing Orbital Shaker "SHO-1D" except Platform and The Shaker "SHO-1DI" can be Accepted Optional Various Platforms; See "Shakers" Section

- **Made in Korea** ■ **PL(Product Liability) Insurance** ■ **2-Year Warranty**
- **Applications Microorganism / Clone Culture & Storage, Reaction Experiment of Enzyme Immunity & Bacteriophage in Vitro Packaging, DNA Ligation, etc.**
- **2-Step Temperature Control(PID Micro Processor) ; With 2-Step Setting Temp. Microorganism is Cultivated and Preserved by One Time(Setting time 99 hours)**
- **ABS-Resin Chamber & Housing; Light-weight / Compact Design Good for Money & Space Saving and Personal Use.**
- **Certificate & Traceability : Controlled by Serial Number, Certificate, Delivery-Information, and Traceable Data Base System.**

- * Cooling / Heating System of PELTIER ELEMENT;
 - Cooling and Heating by using Thermoelectric Semiconductor Element
 - Minimizes Noise (<20dB) and Power Consumption
- * Auto Tuning : Rapid Response and High Stability According to the Thermal Properties and the Rate of Thermal Response of the Object
- * Safety Device : Over Temperature & Over Current Protection, Sensor Error Detection
- * There are 4-Connection Device to Join a Shaker "SHO-1DI" in the Bottom outside of the Incubator "IR-20"

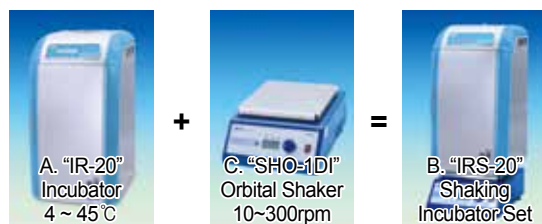

Figure; Assembly Shaking Incubator
 You can easily connect the Incubator & Shaker

Specifications & Ordering Information

Spec.	Model	A. Standard Incubator "ThermoStable™ IR-20"	B. Shaking Incubator Set "ThermoStable™ IRS-20"
Capacity (Lit)		20Lit Working Chamber	
Temp. Range		4°C ~ 45°C, 0.1°C; Digital PID Control	
Accuracy		± 0.2°C (No Load)	
Uniformity		± 0.2°C (at 37°C)	
Cooling / Heating		Peltier Element Module	
2-Step Operation		Ideal for Cultivation and Preservation	
Air Flow-type		Gravity Flow Circulation	
1 Shelf and 3 Location Brackets		1 Perforated ABS Shelf(w210×d230×Thick 8mm) included Adjustable Shelf Location Height of 3-Stage	
Condensate Drain		Natural Evaporation	
Incubator Material		"ABS-Resin" Chamber & Housing, Except Shaking Base	
Incubator Dimension	Interior	w213×d265×h360mm Chamber Only	
	Exterior	w280×d330×h510mm	w280×d330×h670mm; Including Shaking Base
C. SHAKING-Base; Connecting the Multiuse Shaking "SHO-1DI"			
	- Motion&Speed		- Orbital, 10 ~ 300rpm, 15mm Stroke
	- Controller&Display		- Programmable Digital Feedback, LCD
	- Timer&Alarm		- 99hr 59min with ∞ Run, Error Status & Time End
	- Motor&Max-Load		- Brushless DC Motor, Max-Load 10kg
	- Safety Circuit		- Overload Protector of Motor
	- Material		- Powder Coated Steel Body
	- Size&Weight		- w260×d330×h140mm, 14kg
Net Weight (kg)		7kg	7kg+14kg Shaking Base ("SSO-1DI") = 21kg
Packing Size & Weight		9kg	25kg
Power Consumption		56W	56W+40W (Shaking)
Electric Reqt.s.		Free Voltage; 1Phase, AC90-240V, 50 / 60Hz	
Cat. No.	230V	DH.IncR020	DH.IncRS020
	120V	DH.IncR020.1	DH.IncRS020.1
Price, Set. ₩			



B. "IRS-20" Low Temp. Shaking Incubator Set

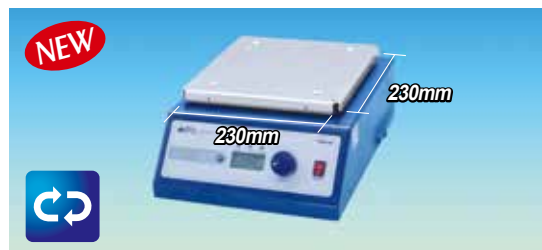

C. "SHO-1DI" Separable Orbital Shaker
 ; It can be Used Individually and Be Accepted

C. SHAKING-Base; Orbital Shaker

DH.SHO01DI Shaker "SHO-1DI", 230V
 DH.SHO01DI.1 , 120V

Ea.	Price, ₩

※ Note! Details of Optional Various Platforms : See The "Shaker" Section

DAIHAN® Precise Shaking Incubator “ThermoStable™ IS-20”, BenchTop-type, up to 60°C & 1000ml
 With Universal Platform, Fuzzy Control, RS232C Interface for PC, Orbital Motion, 30~250 rpm, 101 Lit
 진탕 배양기/인큐베이터, 벤치 탑 타입, 고정밀 디지털 퍼지 제어, Universal Platform 포함



A. “IS-20” R/T ±5°C~ 60°C
 B. “IS-20R” 10°C~ 60°C Refrigerated



Connection of Temperature Devices with Interface RS232C to a PC Export Recorded Data (Excel Spreadsheet)

WiseRemote Control Software :
 Download from DAIHAN-Sci.com

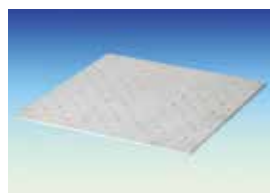

(1) Universal Platform “SP600” (Included)
 (2) Universal Spring Rack Platform “SR500” (Optional)

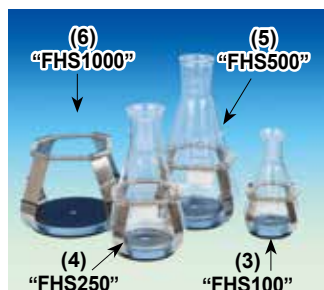

STS Flask Holder w/Spring Ring (Optional)

- DH.WIS504600 (1) Spare Universal Platform, 478×478mm, “SP600”, for “IS-20(R)”, Included
 DH.WIS504500 (2) Spare Universal Spring Rack, 483×483×h135mm, “SR500”, for “IS-20(R)”
 DH.WIS600100 (3) STS Wire Spring Flask Holder, for 100ml Flask, “FHS100”, for “SHO”, “SHR” and “IS”
 DH.WIS600250 (4) , for 250ml Flask, “FHS250”, for “SHO”, “SHR” and “IS”
 DH.WIS600500 (5) , for 500ml Flask, “FHS500”, for “SHO”, “SHR” and “IS”
 DH.WIS601000 (6) , for 1000ml Flask, “FHS1000”, for “SHO”, “SHR” and “IS”

- Made in Korea
- CE Certified
- PL (Product Liability) Insurance
- with Certificate & Traceability : Controlled by Serial Number, Certificate, Delivery-information, and Traceable Data Base System
- Useful for Biological Cultures under various Temperature
- Patented Jog-Shuttle Control System
- Stabilized Orbital Motion

- * Precise Temperature Control by Digital Fuzzy Controller, up to 60°C, PT100 Sensor
- * Advanced Shaking Mechanism Provides Quiet Shaking and Precise Speed Control
- * Automatic Stop of Shaking, Heating and Refrigeration when a Door opens
- * Over Temperature & Over Current Protection, Sensor Error Detection and Leakage Breaking
- * Accommodate Flasks up to 1,000ml
- * Minimum Noise and No Vibration
- * RS232C Interface for Monitoring and Controlling with PC
- * Universal Spring Rack for Various Shapes/Sizes of Flasks (Optional)

Specifications & Ordering information

Spec.	Model	A. “ThermoStable™ IS-20”	B. “ThermoStable™ IS-20R” with Refrigerator
Temp. Range		Room Temp. +5°C ~ 60°C	10°C ~ 60°C
Temp. Accuracy & Uniformity		Accuracy : ±0.2°C at 37°C, Uniformity : ±0.5°C at 37°C	
Capacity		101Lit	
Temp. Sensor		PT100 Sensor	
Heater		500 W	700 W
Compressor		None	1/4 HP
Compressor Control		None	Intelligent Control of Refrigerator for preventing Overload of Compressor
Refrigerant		None	CFC-Free(404A) Refrigeration System
Shaking Speed & Stroke		30 ~ 250 rpm, 25mm, Orbital Motion	
Timer & Alarm		99hr 59min (with Continuous run.), Error status & Timer-end	
Display		Digital LCD with Back-Light Function	
Controller		Digital Fuzzy Controller with Jog-Shuttle Switch (Turn+Push)	
Room Lamp		60W Krypton Lamp	
Platform(Included) & Capacity for Optional Flask Holders		Universal Platform for Various Shapes & Sizes of Flasks Capacity : 32 ea Flask Holders for 50~100ml Flask 20 ea Flask Holders for 200~300ml Flask 16 ea Flask Holders for 500~1,000ml Flask	
Safety Circuit		Over Temp./ Current Protector, Leakage Breaker, Sensor Error Detector	
Material		Internal : Stainless-steel (# 304), External : Powder Coated steel	
Dimension		Internal : 530×530×h350mm, External : 575×855×h850mm	
Packing Size (w×d×h) (mm)		1,000×800×h1,100mm	
& Gross Weight		147 kg	150 kg
Power Consumption		500 W	1.2 kW
Electrical Reqt.s.		1 Phase, AC 120 V, 60 Hz or AC 230 V, 50 / 60 Hz	

Cat. No.	60Hz	230V	DH.WIS00220	DH.WIS01220
		120V	DH.WIS00120	DH.WIS01120
	50Hz	230V	DH.WIS00520	DH.WIS01520
		120V	DH.WIS00420	DH.WIS01420

Price, Each. ₩

* Other Specifications are available upon Customer's Request.

※ 운임 약 ₩ 40,000별도!

C. Validation (IQ, OQ) Service Shaking Incubator

DH.WIS32010 Validation Service(IQ, OQ), with “IS-20”, 60Hz, “ISV2010”
 DH.WIS32011 , with “IS-20R”, 60Hz, “ISV2011”

Ea. Price, ₩

Optional Spring Rack Platform and Stainless-steel Flask Holder(w/Spring Ring)

Ea. Price, ₩

DAIHAN® Precise Shaking Incubator “ThermoStable™ IS-30”, Front Door-type, up to 60°C & 1000ml
 With Universal Platform, Fuzzy Control, RS232C Interface for PC, Orbital Motion, 30~250 rpm, 127 Lit
 진탕 배양기/인큐베이터, 전면도어 타입, 고정밀 디지털 퍼지제어, Universal Platform 포함



A. “IS-30” R/T ±5°C~60°C
 B. “IS-30R” 10°C~60°C Refrigerated

- Made in Korea ■ CE Certified ■ PL(Product Liability) Insurance
 - with Certificate & Traceability : Controlled by Serial Number, Certificate, Delivery-information, and Traceable Data Base System
 - Useful for Biological Cultures under various Temperature
 - Patented Jog-Shuttle Control System ■ Stabilized Orbital Motion
- * Precise Temperature Control by Digital Fuzzy Controller, up to 60°C, PT100 Sensor
 * Front Door and Sliding Platform Provides Easy Loading and Handling of Samples
 * RS232C Interface for Monitoring and Controlling with PC.
 * Advanced Shaking Mechanism Provides Quiet Shaking and Precise Speed Control
 * Accommodate Flasks up to 1,000ml * Minimum Noise and No Vibration.
 * Universal Spring Rack for Various Shapes/Size of Flasks (Optional)
 * Automatic Stop of Shaking, Heating and Refrigeration when a Door opens
 * Over Temperature & Over Current Protection and Leakage Breaking.

Specifications & Ordering information

Spec.	Model	A. “ThermoStable™ IS-30”	B. “ThermoStable™ IS-30R” with Refrigerator
Temp. Range		Room Temp. +5°C ~ 60°C	10°C ~ 60°C
Temp. Accuracy & Uniformity		Accuracy : ±0.2°C at 37°C, Uniformity : ±0.5°C at 37°C	
Capacity		127Lit	
Temp. Sensor		PT100 Sensor	
Heater		600 W	800 W
Compressor		None	1/4 HP
Compressor Control		None	Intelligent Control of Refrigerator for preventing Overload of Compressor
Refrigerant		None	CFC-Free(404A) Refrigeration System
Shaking Speed, Stroke & Motion		30 ~ 250 rpm, 25mm, Orbital Motion	
Timer & Alarm		99hr 59min (with Continuous run.), Error status & Timer-end	
Display		Digital LCD with Back-Light Function	
Controller		Digital Fuzzy Controller with Jog-Shuttle Switch (Turn+Push)	
Platform(Included) & Capacity for Optional Flask Holders		Universal Platform for Various Shapes & Sizes of Flasks Capacity : 35 ea Flask Holders for 50~100ml Flask 16 ea Flask Holders for 200~300ml Flask 12 ea Flask Holders for 500~1,000ml Flask	
Safety Circuit		Over Temp./ Current Protector, Leakage Breaker	
Material		Internal : Stainless-steel (# 304), External : Powder Coated steel	
Dimension		Internal : 570×465×h470mm, External : 916×730×h683mm	
Packing Size (w×d×h) (mm) & Gross Weight		1,050×900×h900mm	
		146 kg	156 kg
Power Consumption		600 W	1.3 kW
Electrical Reqts.		1 Phase, AC 120 V, 60 Hz or AC 230 V, 50 / 60 Hz	



Connection of Temperature Devices with Interface RS232C to a PC Export Recorded Data (Excel Spreadsheet)

WiseRemote Control Software : Download from DAIHAN-Sci.com

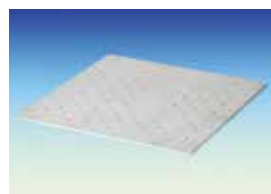

(1) Universal Platform “SP630” (Included)



(2) Universal Spring Rack Platform “SR530” (Optional)

Cat. No.	60Hz	230V	DH.WIS00230	DH.WIS01230
		120V	DH.WIS00130	DH.WIS01130
50Hz	230V	DH.WIS00530	DH.WIS01530	
	120V	DH.WIS00430	DH.WIS01430	

Price, Each. ₩

* Other Specifications are available upon Customer’s Request.

※ 운임 약 ₩ 40,000 별도!

C. Validation (IQ, OQ) Service Shaking Incubator

DH.WIS33010 Validation Service(IQ, OQ), with “IS-30”, 60Hz, “ISV3010”
 DH.WIS33011 , with “IS-30R”, 60Hz, “ISV3011”

Ea. Price, ₩

Optional Spring Rack Platform and Stainless-steel Flask Holder(w/Spring Ring)

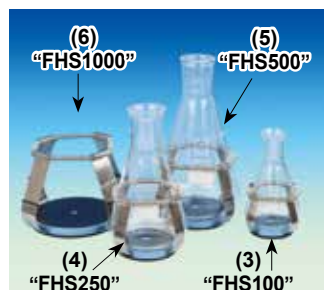

STS Flask Holder w/Spring Ring (Optional)

- DH.WIS504630 (1) Universal Platform, 485×405mm, “SP630”, for “IS-30(R)”
- DH.WIS504530 (2) Universal Spring Rack, 498×408×h135mm, “SR530”, for “IS-30(R)”
- DH.WIS600100 (3) STS Wire Spring Flask Holder, for 100ml Flask, “FHS100”, for “SHO”, “SHR” and “IS”
- DH.WIS600250 (4) , for 250ml Flask, “FHS250”, for “SHO”, “SHR” and “IS”
- DH.WIS600500 (5) , for 500ml Flask, “FHS500”, for “SHO”, “SHR” and “IS”
- DH.WIS601000 (6) , for 1000ml Flask, “FHS1000”, for “SHO”, “SHR” and “IS”

Ea. Price, ₩

DAIHAN® Precise Shaking Incubator “ThermoStable™ IS-10”, Top Door-type, Orbital Motion, up to 60°C, ±0.2°C With Universal Platform, Fuzzy Control, with or without illuminators & Recorder, 30~250 rpm, with Certi. & Traceability 진탕 배양기/인큐베이터, 탑 도어 타입, 고정밀 디지털 퍼지 제어, Universal Platform 포함



A. Room Temp. +5°C~60°C, With Universal Platform “ThermoStable™ IS-10”



WiseRemote Control Software : Download from DAIHAN-Sci.com

Connection of Temperature Devices with Interface RS232C to a PC Export Recorded Data (Excel Spreadsheet)

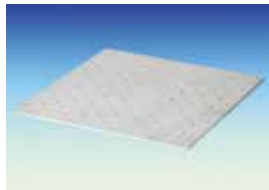

(1) Universal Platform “SP610” (Included)

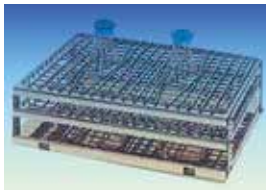

(6) Universal Spring Rack Platform “SR510” (Optional)

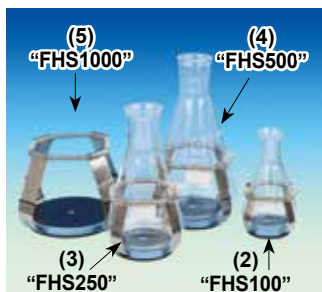

STS Flask Holder w/Spring Ring (Optional)

- Made in Korea
- CE Certified
- PL (Product Liability) Insurance
- with Certificate & Traceability : Controlled by Serial Number, Certificate, Delivery-information, and Traceable Data Base System
- Useful for Biological Cultures under various Temperature
- Patented Jog-Shuttle Control System

- * Precise Temperature Control by Digital Fuzzy Controller, up to 60°C
- * Digital LCD with Back-Light Function
- * Minimum Noise and No Vibration
- * Advanced Shaking Mechanism Provides Quiet Shaking and Precise Speed Control
- * Automatic Stop of Shaking, Heating and Refrigeration when a Door opens
- * Intelligent Control of Refrigerator for preventing Overload of Compressor (IS-10R/IS10RL)
- * RS232C Interface for Monitoring and Controlling with PC

Specifications & Ordering information

Spec.	Model	A. IS-10	B. IS-10R with Refrigerator	C. IS-10RL Illumination
Temp. Range		R/T +5°C ~ 60°C	10°C ~ 60°C	
Temp. Accuracy & Uniformity		Accuracy : ±0.2°C at 37°C, Uniformity : ±0.5°C at 37°C		
Capacity		229Lit		
Temp. Sensor		PT100 Sensor		
Heater		800 W	1 kW	1.2 kW
Compressor		None	1/3HP	
Refrigerant		CFC-Free (404A) Refrigeration System		
Shaking Speed & Stroke		30 ~ 250 rpm, 25mm Orbital Motion		
Timer & Alarm		99hr 59min (with Continuous run.), Error status & Timer-end		
Controller		Digital Fuzzy Controller with Jog-Shuttle Switch (Turn+Push)		
Illumination System		None	FPL 55W×4ea	
Room Lamp		Krypton Lamp, 60W		None
Platform(Included)		Universal Platform for Various Shapes & Sizes of Flasks		
Safety Circuit		Over Temp./ Current Protector, Leakage Breaker, Sensor Error Detector		
Material		Internal : Stainless-steel (#304), External : Powder Coated steel		
Dimension		Internal : 750×720×h400mm, External : 1,065×900×h980mm		
Packing Size (w×d×h) (mm)		1,220×1,060×h1,200mm		
& Gross Weight		231 kg	238 kg	238 kg
Power Consumption		800 W	1.8 kW	2.1 kW
Electrical Reqts.		1 Phase, AC 120 V, 60 Hz or AC 230 V, 50 / 60 Hz		

Cat. No.	60Hz	230V	DH.WIS00210	DH.WIS04210	DH.WIS05210
		120V	DH.WIS00110	DH.WIS04110	DH.WIS05110
	50Hz	230V	DH.WIS00510	DH.WIS04510	DH.WIS05510
		120V	DH.WIS00410 <td>DH.WIS04410 <td>DH.WIS05410 </td></td>	DH.WIS04410 <td>DH.WIS05410 </td>	DH.WIS05410

Price, Each. ₩

* Other Specifications are available upon Customer's Request.

※ 운임 약 ₩ 40,000별도!

D. Validation (IQ, OQ) Service Shaking Incubator

- DH.WIS31010 Validation Service(IQ, OQ), with “ThermoStable IS-10”, 60Hz
- DH.WIS31011 , with “ThermoStable IS-10R”, 60Hz
- DH.WIS31012 , with “ThermoStable IS-10RL”, 60Hz

Ea. Price, ₩

Optional Spring Rack Platform/Recorder/Stainless-steel Flask Holder(with Spring Ring)

- DH.WIS504610 (1) Spare Universal Platform, w688×h648mm, “SP610”, Flask Holder Capacity ; 68ea for 50~100ml Flask, 36ea for 200~300ml Flask, 21ea for 500~1000ml Flask
- DH.WIS600100 (2) STS Wire Spring Flask Holder, for 100ml Flask , “FHS100”
- DH.WIS600250 (3) , for 250ml Flask , “FHS250”
- DH.WIS600500 (4) , for 500ml Flask , “FHS500”
- DH.WIS601000 (5) , for 1000ml Flask, “FHS1000”
- DH.WIS504510 (6) Universal Spring Rack, w693×d653×h135mm, “SR510”
- DH.WTH05100 (7) Temperature Recorder, with 6ea Ribbon Cassette & Chart Paper LED, 6ch/10sec, 144×144×h233mm, “WTH5105”
- DH.WTH05108 Ribbon Cassette, 6 Colors, “WTH5108”
- DH.WTH05105 Chart Paper, w100mm×L10m, 33 Days, “WTH5105”

Ea. Price, ₩

DAIHAN® Multi-Stack Refrigerated Shaking Incubator “WIS-ML”, Orbital Motion, with 2 & 4 Universal Platform With Digital Fuzzy Control, 2 or 4 Independent Shaking Speed Control, 10~60°C, 30~250 rpm, 2 & 4 Stack 대형 멀티 진탕 배양기, 고정밀 디지털 퍼지 제어, 2 & 4 Universal Platform 포함



B. Multi-Stack Refrigerated Shaking Incubator with 4 Universal Platform “WIS-ML04”

- Made in Korea ■ CE Certified ■ PL(Product Liability) Insurance
- with Certificate & Traceability : Controlled by Serial Number, Certificate, Delivery-information, and Traceable Data Base System
- Excellent for Multi-use and wide range of Sample Testing under various Temperature
- Patented Jog-Shuttle Control System
- * Digital Fuzzy Control System Implementing Superior Temperature Accuracy
- * Intelligent Control of Refrigerator for Preventing Overload of Compressor
- * Advanced Shaking Mechanism provides Quiet Shaking and Precise Speed Control
- * Space Saving Design for Large Quantity Samples with 2 or 4 Independent Shaking Speed Controller
- * Automatic Stop of Shaking, Heating and Refrigeration when the Door is Opened
- * RS232C Interface for Monitoring and Controlling with PC * Including Universal Platform
- * Over Temperature & Over Current Protection and Sensor Error Detection
- * Universal Spring Rack for Various Shapes/Sizes of Flasks (Optional)

Specifications & Ordering information

※ 운임 약 ₩ 95,000별도!

Spec.	Model	A. “WIS-ML02” 2 Shaking Platform	B. “WIS-ML04” 4 Shaking Platform
Shaking Stacks		2 Stack	4 Stack
Temp. Range & Accuracy		10°C~ 60°C, ±0.2°C at 37°C	
Temp. Uniformity & Sensor		±1.0°C at 37°C, PT100 Sensor	
Heater		1.5 kW	1.8 kW
Compressor		1/2HP	3/4HP
Compressor Control		Intelligent Control of Refrigerator for Preventing Overload of Compressor	
Refrigerant		CFC-Free(404A) Refrigeration System	
Shaking Speed & Stroke		30 ~ 250 rpm, 25mm Orbital Motion	
Timer & Alarm		99hr 59min (with Continuous run.), Error status & Timer-end	
Display		Digital LCD with Back-Light Function	
Controller		Digital Fuzzy Controller with Jog-Shuttle Switch (Turn+Push)	
Door		Magnetic Packing Door with Pair Glass	
Plate Size		w700×d600mm	
Platform(Included) & Capacity for Optional Flask Holders		Universal Platform for Various Shapes & Sizes of Flasks Capacity : 68 ea Flask Holder, for 50~100ml Flask 36 ea Flask Holder, for 200~300ml Flask 21 ea Flask Holder, for 500~1,000ml Flask	
Safety Circuit		Over Temp./ Current Protector, Sensor Error Detector	
Material		Internal : Stainless-steel (# 304), External : Powder Coated steel	
Dimension (w×d×h)	Internal (mm)	700×700×1,100	700×700×1,790
	External (mm)	1,290×850×1,445	1,290×850×2,125
Packing Size (w×d×h) (mm) & Gross Weight		1,500×1,200×1,750	1,500×1,200×2,350
		397 kg	555 kg
Power Consumption		2.4 kW	3.2 kW
Electrical Reqts.		1 Phase, AC 120V, 60Hz or AC 230V, 50/60Hz	1 Phase AC 120V, 60Hz or AC 230V, 50/60Hz or 3 Phase

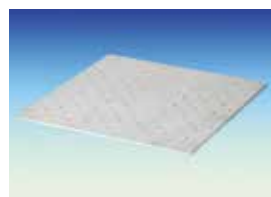

(1) Universal Platform “SP620” (Included)

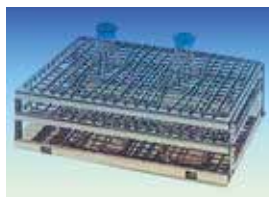

(2) Universal Spring Rack Platform “SR520” (Optional)

Cat. No.	230V	DH.WIS05002	DH.WIS05004
	120V	DH.WIS05102	DH.WIS05104
	3Phase	-	DH.WIS03004

Price, Each. ₩

* Other Specifications are available upon Customer's Request.

※ 운임 약 ₩ 95,000별도!



STS Flask Holder w/Spring Ring (Optional)

C. Validation (IQ, OQ) Service Shaking Incubator

DH.WIS35002 Validation Service(IQ, OQ), with “WIS-ML02”
DH.WIS35004 , with “WIS-ML04”

Ea. Price, ₩

--

Optional Spring Rack Platform and Stainless-steel Flask Holder(with Spring Ring)

- DH.WIS504620 (1) Universal Platform, w645×h645mm, “SP620”, for “WIS-ML02/04”, Included
- DH.WIS504520 (2) Universal Spring Rack, w653×d653×h135mm, “SR520”, for “WIS-ML02/04”
- DH.WIS600100 (3) STS Wire Spring Flask Holder, for 100ml Flask , “FHS100”
- DH.WIS600250 (4) , for 250ml Flask , “FHS250”
- DH.WIS600500 (5) , for 500ml Flask , “FHS500”
- DH.WIS601000 (6) , for 1000ml Flask, “FHS1000”

Ea. Price, ₩

--



(1) Fluorescent Light Magnifier "BLM-F"

Wisdom Multi-use Fluorescent Light Magnifier "BLM-F", ×5 · ×8 Magnification
Base Stand-type, φ 127mm B270 High Clear White Glass Lens, Flexible Arm, 12W, 형광 조명 확대경

- Made in Korea
- Ideal for Laboratory, Hospital, Circuit Board Check-Up, etc.
- International Standard φ 127mm B270 White Glass Lens
- Light Source : High Brightness Daylight Blue Fluorescent
- 20% Energy Saving Ballast Stabilizer Control System
- Adjustable Height and Lens Angle Direction
- 2-Stage Spring Flexible Arm

- * Light Illumination : 2,800lx
- * Adjustable Height : 300 ~ 500mm
- * Base Size : 220×33 mm
- * Electric Power : AC 220V, 12W

Ordering Information

DH.Mag3105 Magnifier, Fluorescent Light, ×5, "BLM-F105"
DH.Mag3108 , ×8, "BLM-F108"

Ea.	Price,₩



(2) LED Light Magnifier "BLM-L"

Wisdom Multi-use LED Light Magnifier "BLM-L", ×5 · ×8 Magnification
Base Stand-type, φ 127mm B270 High Clear White Glass Lens, Flexible Arm, 12W, LED 조명 확대경

- Made in Korea
- Ideal for Laboratory, Hospital, Circuit Board Check-Up, etc.
- International Standard φ 127mm B270 White Glass Lens
- Light Source : High Brightness White LED Bulbs (36ea)
- Adjustable Height and Lens Angle Direction
- 2-Stage Spring Flexible Arm
- Scratch and Nick-Resistant PP Lens Cover

- * Ultra Bright LED Light : 5,000lx
- * Adjustable Height 300 ~ 350mm
- * Base Size : 220×330mm
- * Electric Power : AC 220V, 12W

Ordering Information

DH.Mag3205 Magnifier, Fluorescent Light, ×5, "BLM-L105"
DH.Mag3208 , ×8, "BLM-L108"

Ea.	Price,₩

DAIHAN® Pocket Anemometer of Flow/Temp/RH%/Dew-point/Compass, Foldable, IP54 Water Resistance & Shock Proof
 1.1~20m/s, -15+50°C, 0~100% RH, Dew-point & Compass 360°, Tripod-stand Mountable, 소형 다기능 아네모메타



Pocket Anemometer for 3×Measuring

- * Small Pocket Knife Shape & Compact Design. * IP54 Water Resistant & Shock Proof. * LCD Size : 16×28mm
- * Temp. Units °C/°F Selectable. * Auto Sleep Mode Disable Included. * Tripod Mountable Receptacle.
- * Measures 7 Parameters : Air Velocity, Compass, Temperature, Humidity, Windchill, Wet Bulb & Dew Point
- * 6 Wind Units Selectable : KNT(Knot), BF(Beaufort), FPM(Feet Per Minute), MPH(Mile Per Hour), MPS(Meter Per Second), KPH(Kilometer Per Hour).

Specifications & Ordering information

Spec.	Model	DH.Ane5	Set
3× Measuring Range		(1) Wind Speed : 0.5 ~ 44.7m/h, 60 ~ 3937ft/m, 0.4 ~ 38.8knt, 1.1 ~ 20.0m/s, 0.7 ~ 72.0km/h, 1 ~ 8bf, (2) Temp. : -15°C ~ +50°C, (3) RH% : 0%RH ~ 100%RH	
Accuracy		(1) Wind Speed : ±(3% of Reading +0.2m/s), (2) Temp. : ±1°C, (3) RH% : ±3%RH(at 25°C, 10 ~ 90%RH, other ±5%RH)	
Resolution		(1) Temp. : 0.1°C/°F, (2) RH% : 0.1%RH	
Display		(1) Windchill : -20.0°C ~ 50.0°C, (2) Dew Point : -20.0°C ~ 50.0°C, (3) Wet Bulb : -5.0°C ~ 50.0°C, (4) Compass : 0~360 Degree	
Battery		1×CR2032 Battery	
Dimension & Weight		140×45×h25 mm (90° Folded), 235×45×h25 mm (180° Full Opened) / 90g	
Standard Package		Meter / Battery / Manual / Strap / Paper Box	
Cat. No. & Price ₩		DH.Ane3005	Set
Spare ; DH.Ane3005.1		Mini Fan for Anemometer	Ea

DAIHAN® Combo-Anemometer of Flow / Temp / RH% / Dew-point, PC-interface, Datalogging
 0.5m/s, -20+60°C, 0.1~99.9% RH, -20+59.9°C D-point, & Wet Bulb, with 18mm Vane Probe & Cable, 정밀 아네모메타



Combo - Anemometer Hard Carrying Case

- * Measures Air Velocity, Volume, Temperature, Humidity, Dew Point & Wet Bulb Temperature.
- * Thermistor Temp. Sensor and Capacitive Humidity Sensor for Quick and Accurate Measurement.
- * 18mm Mini Vane Probe with Built-in Temp. & Humidity Sensor. * 99 Single Point Memories.
- * Winds Peed Metric and Imperial Units Selectable. * Up to 12000 Points Auto Datalogging Points.
- * PC Interface for Data download * Date and Time Stamp (12-Hour or 24-Hour)

Specifications & Ordering information

Spec.	Model	DH.Ane3	Set
3× Measuring Range		(1) Wind Speed : 0.5 ~ 20M/S, (2) Temp. : -20°C ~ 60°C, (3) RH% : 0.1 ~ 99.9%RH	
Accuracy		(1) Wind Speed : ±(3% of reading + 0.2M/S), (2) Temp. : ±0.6°C, (3) RH% : ±3%RH(at 25°C, 10 ~ 90%RH, other ±5%RH)	
Resolution		(1) Temp. : 0.1°C/°F, (2) RH% : 0.1%RH	
Display		(1) Wet Bulb & Dew Point Temp. : -20°C ~ +59.9°C, (2) Air Volume : 0 to 99999m³/min	
Battery		4×AAA Battery or 9V DC Adaptor	
Dimension & Weight(g)		180×58×h24.5 mm (LCD Size : 54×37 mm) / 200g	
Standard Package		Meter / Probe / Battery /Manual / Hard Carrying Case / Software Kit	
Cat. No. & Price ₩		DH.Ane3003	Set
Spare ; DH.Ane3003.1		Expanded Vane Probe, 273×18.5mm (1055mm Extended), w/Rubber Holder	Ea

DAIHAN® Digital Anemometer Set, for Air Velocity & Temperature, Max/Min/Average
 With 10 Memories Data Storage / Recalling / Clearing, m/s · m/hr · ft/min · knots, and °C/°F



Digital Anemometer Set, for Air Velocity / Temp.

- * Ideal for Professional in Aviation, Laboratory and Ventilation Systems. * CE Approval.
- * Instant Display of the Air Velocity and Temperature. * Maximum, Minimum and Average Calculation.
- * Selectable Air Velocity Unit m/s, km/hr, mph, ft/min or Knots. * Switchable Temperature Unit °C/°F.
- * 10 Memories Data Storage/Recalling/Clearing. * 1/4in. 20 UNC Threading for Tripod Mounting.

Specifications & Ordering information

Spec.	Model	A1.A9201	Ea
2× Measuring Range		(1) Temp.: -50°C to +70°C or -58°F ~ +158°F, (2) Air Velocity : 0.5 to 45.0m/s · 1.8 to 162.0km/hr · 1.1 to 100.0mph, 98 to 880ft/min · 1.0 to 88.0knots	
Accuracy		(1) Temp.: ±0.5°C(for 0°C~+50°C) or ±0.9°F(for +32°F~122°F), otherwise ±1°C or 1.8°F, (2) Air Velocity : ±2%	
Resolution		(1) Temp.: 0.1 for whole Range, (2) Air Velocity : 0.1	
Color / Ambient Temp.		Grey / 0°C to +50°C or +32°F~+122°F	
Battery / Probe Type		3×1.5V AAA Battery / NTC-Probe : 76×67×32mm (1Meter Cable)	
Dimension / Weight(g)		85×175×h39mm (LCD Size : 54×35 mm) / 200g	
Cat. No. & Price ₩		A1.A9201	Ea

DAIHAN® Precise 10cm Vane Anemometer of Flow / Temp / RH% / Dew-point / Wet Bulb / Air Volume
 2 Dedicated Flow Funnel Acceptable, 0.2~30m/s, -20+60°C, 0.1~99.9% RH, D-point & 99,999m³/min, 정밀 아네모메타



Precise 10cm Vane Anemometer



Round (φ210mm) Square (346×346mm) Air Flow Cone Set(Optional)

- * Measures Air Velocity, Volume, Temperature, Humidity, Dew Point & Wet Bulb Temperature.
- * Built-in Thermistor Temp. & Capacitive Humidity Sensor for Quick and Accurate Measurement.
- * Unlimited Points & Time Weighted Average Auto Calculation.
- * Hold Function Freezes Current Readings
- * Inlet and Outlet Measurement is Doable
- * Auto Power off 20mins Inactivity.
- * Blue Backlight for Dark Area Operation.
- * Display Max / Min Value.
- * Low Battery Indicator

Specifications & Ordering information

Spec.	Model	DH.Ane7
3× Measuring Range		(1) Wind Speed : 0.2 ~ 30M/S, (2) Temp. : -20°C ~ 60°C, (3) RH% : 0.1%RH ~ 99.9%RH
Accuracy		(1) Wind Speed : ±(1.5% of Reading +0.3m/s) for under 20m/s, ±(3% of Reading +0.3m/s) for above 20m/s, (2) Temp. : ±0.6°C, (3) RH% : / ±3%RH(at 25°C, 10 ~ 90%RH, other ±5%RH)
Resolution		(1) Temp : 0.1°C/°F, (2) RH% : 0.1%RH
Display		(1) Wet Bulb Temp. : -20°C ~ +59.9°C, (2) Dew Point Temp. : -5°C ~ +59.9°C, (3) Air Volume : 0 to 99999m ³ /minute
Temp. Respond Time		60 second (Typical)
Air RH% Response Time		60 second (Typical)
Battery		4×AAA Battery
Dimension & Weight		269×106×h51 mm (LCD Size : 32.5×54 mm) / 200g
Standard Package		Meter / Manual / Battery / Hard Carrying Case
Cat. No. & Price ₩	DH.Ane3007	Set
Option ; DH.Ane3007.1	Air Flow Cone, Round(φ210mm) + Square(346×346mm) Set	Set

DAIHAN® Digital/Compact Environmental Multi-Meter, with EL Backlight, Rubber Coated
 For Air Pressure “mb” / Altitude “m” / Temp “°C” / Direction “°” / Weather Forecasting / Calendar / Alarm Timer
 With Jumbo LCD Display, 휴대용 디지털 멀티 메타, 기압 / 고도 / 방위 / 일기예보 / 시계 / 달력표시



Digital/Compact Environmental Multi-Meter

- * CE Approval.
- * Ideal for All Kind of Environmental Measurements, Laboratory
- * Simultaneous Display of Air Pressure, Altitude, Temperature and Compass.
- * Bargraph Display of Air Pressure and Altitude.
- * Weather Forecasting in Graphic Display.
- * Calendar and Clock/Timer(with Alarm) Setting.
- * Easy Operation Via Six Function Keys.
- * EL Backlight for Use in Dim Light Environment.
- * Convenient Design with Lanyard for Carrying.

Specifications & Ordering information

Spec.	Model	A1.A9202
4× Measuring Range		(1) Air Pressure: 300~1100mb(hPa) or 8.85inHg~32.45inHg, (2) Altitude : -700 ~+9000m or -2296ft~+29520ft, (3) Temp.: -10°C ~+60°C or -14°F~+140°F, (4) Direction : 0~359°
Sensing Time		(1) Air Pressure: 15min, (2) Altitude : 2 sec, (3) Temp.: 1min, (4) Direction : 1sec. for 1min
Resolution		(1) Air Pressure: 1mb/hPa or 0.01inHg, (2) Altitude 0.1m for -500.0m to 999.9m, Otherwise 1m, (3) Temp.: 0.1°C or 0.1°F, (4) Direction : 1°C
Color / Ambient Temp.		Grey / 0°C to +50°C or +32°F~+122°F
Weight (g) / Timer / Color		110g / 23hr 59min 59sec / Yellow:Grey
Battery / Package		2×3 V “CR2032” Size or Equivalent / Standard Color Box
Sensor Type		NTC-Probe, Pressure Sensor and Magnetic Sensor
Dimension / Weight(g)		85×62×24mm(LCD Size : 40×39 mm)
Cat. No. & Price ₩	A1.A9202	Ea



DAIHAN® Methane & Propane Gas Leak Detector, with Alarm, 40~640 ppm With 5-Level Leakage Indicator & Auto-Calibration Function, 메탄 & 프로판가스 누출 검지기

- * Low Cost Handheld type Detector Checking Methane and Propane Gas Leakage.
- * Bright 5-Level Leakage LED Indicator.
- * Quality & Reliable Semi-Conductor Sensor.
- * Built in Auto-Calibration Function while Meter Powers on.
- * Long & Flexible Stainless Goose Neck Detect Probe.
- * Status Ready and Battery Low LED Indicator.
- * Acoustic Intermittent Beep.
- * Auto Power off Timeout about 10 mins.
- * Built in Earphone Jack for Mute Mode Use.

Specifications & Ordering information

Spec.	Model	DH.Gas3
Methane / Propane Range		40 ~ 640 ppm
Sensitivity		40 ppm (Methane & Propane)
Response Time & Warm Up		within 10 seconds / within 60 seconds
Battery		4 × AA Battery or 9V Adaptor
Flexible Probe Length		18" (465mm)
Dimension & Weight(g)		175 × 47 × h28 mm / 120g
Standard Package		Meter / Manual / Battery / Carrying Case
Cat. No. & Price ₩	DH.Gas3003	Set



DAIHAN® Pocket type CO Detector, with Dual LCD Display / Alarm, 0~999 ppm With Wrist Strap / Soft Carrying Pouch, 핸디 일산화탄소(CO) 디텍터

- * Easy to Manually Calibrate at 0 or 500ppm Carbon Monoxide Standard Gas.
- * Dual LCD Display with Current Carbon Monoxide and Maximum CO Readings.
- * Long Life and Reliable Electrochemical Carbon Monoxide Sensor.
- * Warning Carbon Monoxide Audible Alert. Alarm Adjustable, Preset at 25ppm.
- * Low Battery Indicator.
- * Backlight Function Works in Dark Area.

Specifications & Ordering information

Spec.	Model	DH.Gas5
CO Range & Resolution		0 ~ 999 ppm / 1 ppm
Accuracy (at 20 ± 5°C, 50 ± 20%RH)		± 20% at 0 ~ 100ppm ; ± 15% at 100 ~ 500ppm
Response Time / Battery		within 60 seconds / 3 × AAA Battery
Dimension & Weight(g)		175 × 47 × h28 mm (LCD Size : 11 × 26 mm) / 120g
Standard Package		Meter / Manual / Battery / Plain Box / Wrist Strap / Soft Carrying Pouch
Cat. No. & Price ₩	DH.Gas3005	Set

DAIHAN® Combo Air Quality Meter of CO / CO₂ / Temp / RH% / Dew-point / Wet Bulb, PC Data Analysis 0~1000ppm-CO, 0~9999ppm-CO₂, -20+60°C, 0.1~99.9% RH, -20+59.9°C-DP, -5+59.9°C-WB, Alarm 콤보 에어테스터



- * Manual Calibration is available for CO₂ / CO / RH%
- * Designed with electrochemical CO Sensor and NDIR(Non-dispersive Infrared) Waveguide Technology CO₂ Sensor
- * Warning Carbon Monoxide Level Programmable
- * Max, Min, Average Functions Included
- * USB Output to PC for Data Analysis
- * Audible Alarm (~80dB) Threshold Setting
- * 99 Points Memory Review

Specifications & Ordering information

Spec.	Model	DH.Gas7
6 × Measuring Range		(1) CO ₂ : 0 ~ 9999 ppm(5001 ~ 9999 ppm out of scale range), (2) CO : 0 ~ 1000 ppm, (3) Temp. : -20 ~ 60°C (-5 ~ 140°F), (4) RH : 0.1 ~ 99.9%RH, (5) DP : -20 ~ 59.9°C, (6) WB : -5 ~ 59.9°C
Accuracy		(1) CO ₂ : ± 30 ppm ± 5% of reading (0 ~ 5000 ppm), Other ranges are not specified, (2) CO : ± 10 ppm for less than 100 ppm / ± 10% of reading for 101 ~ 500 ppm, ± 20% of reading for 501 ppm and above, (3) Temp. : ± 0.6°C / ± 0.9°F, (4) RH : ± 3%RH(at 25°C, 10~90%RH), ± 5%RH(at 25°C, other range)
Resolution		1 ppm, 0.1°C/°F, 0.1%RH
Response Time		(1) CO ₂ : < 30 seconds (90% step change), (2) CO : < 60 seconds (90% step change), (3) Tair : < 2 mins (90% step change), (4) RH : < 10 mins (90% step change)
Power Supply		4 × AA Battery or 9V adaptor (>24hours, Alkaline Battery)
Dimension & Weight(g)		205 × 70 × h56 mm(LCD Size : 26 × 44 mm) / 200g
Standard Package		Meter / Manual / Battery / USB Cable & CD / Carrying case
Cat. No. & Price ₩	DH.Gas3007	Set
Option ; DH.Gas3007.1	① Cal. Salt Bottle, for Calibration, 33%, 56ml	Ea
DH.Gas3007.2	② , 75%, 56ml	Ea

DAIHAN® “Green Life” Indoor Air Monitor of CO₂ / Temp / RH% and Time Clock, Desktop-model
 With CO₂ Alarm, 0~9999ppm with Auto-Background Calibration, -10+60°C, 0.1~99.9%RH, “그린라이프” 룸에어모니터



Indoor Air Monitor

- * 15 Degree Tilt Angle for Easy to See and Read
- * Warning Carbon Dioxide Level from 1000~5000 ppm
- * Display CO₂ Value (with Good, Normal, Poor Air), Year-Month-Date, Hour-Minute, Air Temp. & Relative Humidity
- * NDIR (Non-dispersive Infrared) Waveguide Technology
- * CO₂ Auto-Background Calibration, ABC

Spec.	Model	DH.Gas9
3× Measuring Range		(1) CO ₂ : 0 ~ 9999 ppm (2001 ~ 9999 ppm out of scale range), (2) Temp. : -10 ~ 60°C (14 ~ 140°F), (3) RH% : 0.1 ~ 99.9%RH
Resolution		1 ppm, 0.1°C/°F, 0.1%RH
Accuracy		(1) CO ₂ : ±50ppm ±5% of reading (0 ~ 2000 ppm), (2) Temp. : ±0.6°C/±0.9°F, (3) RH% : ±5%RH(at 25°C, 20~90%RH), ±7%RH(at 25°C, other range)
Response time		(1) CO ₂ : < 2 mins (90% step change), (2) Tair : < 2 mins (90% step change), (3) RH : < 10 mins (90% step change)
Power Supply		5V DC Adaptor(± 10%), ≥= 500mA
Dimension & Weight(g)		120×80mm(LCD Size : 60×82 mm) / 200g
Standard Package		Meter / Manual / Adaptor / Plain Box
Cat. No. & Price ₩		DH.Gas3009 Set

DAIHAN® Air Quality Meter & Monitor of CO₂ / Temp / RH% / Dew-point / Wet-Bulb, PC Data Analysis
 0~9999ppm-CO₂, -10+60°C, 0.1~99.9% RH, -20+59.9°C-DP, -5+59.9°C-WB, NDIR-Sensor, 다기능 에어 미터/모니터



(1) Air Quality Meter

(1) Air Quality Meter

- * Triple Display 3 Parameters Simultaneously : CO₂, Temperature and Relative Humidity and Display Air / Dew Point / Wet Bulb Temp. by Selection
- * Warning Carbon Dioxide Level
- * Big LCD display with High Resolution
- * Design with NDIR(Non-Dispersive Infrared) Waveguide Technology CO₂ Sensor
- * 80dB-Alarm

Spec.	Model	DH.Gas13
5× Measuring Range		(1) CO ₂ : 0 ~ 9999 ppm, (2) Temp. : -10 ~ 60°C (14 ~ 140°F), (3) RH% : 0.1 ~ 99.9%RH, (4) DP : -20.0 ~ 59.9°C, (5) WB : -5.0 ~ 59.9°C
Accuracy		(1) CO ₂ : ±50 ppm ±5% of reading (0 ~ 2000 ppm), (2) Temp. : ±0.6°C / ±0.9°F, (3) RH : ±3% RH(at 25°C, 10 ~ 90%RH)
Resolution		1 ppm, 0.1°C/°F, 0.1%RH
Response Time		(1) CO ₂ : <30 sec, (2) Tair : <2 min, (3) RH : <10 min. (90% step change)
Warm-up Time / Battery		30 sec. / 4×AA Battery
Dimension / Weight(g)		205×70×h56mm(LCD Size : 26×44mm) / 200g
Standard Package		Meter / Manual / Battery / Hard Carrying Case
Cat. No. & Price ₩		DH.Gas3013 Set



(2) Wallmount Air Quality Monitor

(2) Wallmount Air Quality Monitor

- * Digital Wall mountable / Desktop type
- * Alarm Output Drive Relay to Control System
- * Warning Carbon Dioxide Level
- * with 80dB Alarm
- * Super Large LCD display CO₂ Value
- * NDIR(Non-Dispersive Infrared) Waveguide Technology with ABC(Automatic Background Calibration)
- * PC Output to Computer for on Line Analysis
- * Long Time Drift Compensation

Spec.	Model	DH.Gas15
5× Measuring Range		(1) CO ₂ : 0 ~ 9999 ppm (2001~9999 ppm out of Scale Range), (2) Temp. : -10 ~ 60°C (14 ~ 140°F), (3) RH : 0.1 ~ 99.9%RH, (4) DP : -20.0 ~ 59.9°C, (5) WB : -5.0 ~ 59.9°C
Accuracy		(1) CO ₂ : ±50 ppm ±5% of reading(0 ~ 2000 ppm),(2) Temp. : ±0.6°C / ±0.9°F, (3) RH : ±3% RH(at 25°C, 10 ~ 90%RH) or ±5% RH(at 25°C, others)
Resolution		1 ppm, 0.1°C/°F, 0.1%RH
Response Time		(1) CO ₂ : <30 sec, (2) Tair : <2 min, (3) RH : <10 min. (90% step change)
Warm-up Time		30 sec.
Power Supply		12 VDC Adaptor
Dimension / Weight(g)		130×85×h60mm (LCD Size : 50×65 mm) / 200g
Standard Package		Meter / Manual / 12V Plug Adaptor / Plain Box
Cat. No. & Price ₩		DH.Gas3015 Set



Optional Accessory

- DH.Gas3013.1** ① USB Cable & Software
- DH.Gas3013.2** ② RS232 Cable & Software
- DH.Gas3007.1** ③ Cal. Salt Bottle, for Calibration, 33%, 56ml
- DH.Gas3007.2** ④ , 75%, 56ml

Ea.	Price, ₩

**DAIHAN® Digital Pressure / Vacuum Manometer, 10-Different Units ; psi, mbar, etc, with 8mm Metal Lug
+/- (±) 30psi / 1551mmHg / 2068 mbar, PC Data Analysable, Max-Min / Hold / Record, 디지털 마노미터**



Digital Pressure / Vacuum Manometer



Hard Carrying Case



- **Portable Digital Gauge ; 10 Differential Units Pressure / Vacuum Meter, with 8mm Metal Connection**
- **PC Interface via Cable and Software to Download Data** * Over-range Indication with Error Messages
- * 10 units or 5 units for Selection (Metric, Imperial) * Connection ; 8mm Metal Lug
- * Backlight Function works in Dark Area * Low Battery Indicator * Real Time Shows in Recording Mode

Spec.	Model	DH.Man3003
Range & Resolution	psi	±30.00 & 0.02
	kPa and mmHg	kPa : ±206.8 & 0.2, and mmHg : ±1551 & 1
	Kg/cm² and mbar	Kg/cm² : ±2.109 & 0.002, and mbar : ±2068 & 2
	bar and inH₂O	Bar : ±2.068 & 0.002, and inH₂O : ±830.4 & 0.5
	cmH₂O and inHg	cmH₂O : ±2101 & 2, and inHg : ±61.08 & 0.04
	ftH₂O and oz/inch²	ftH₂O : ±69.2 & 0.04, and oz/inch² : ±480.0 & 0.3
Accuracy		±0.3% of Full Scale at 25°C
Response Time		0.5 sec
Compensated Temp. Range		0~50°C
Battery		9V Battery or Adaptor
Dimension / Weight(g)		182×72×30 mm (LCD Size : 29×51mm) / 150g
Standard Package		Meter, Battery, Manual, 2×Connection Hose(50cm), Hard Carry Case
Cat. No. & Price ₩		DH.Man3003 Set
Option ; DH.Gas3013.1	① USB Cable & Software	Ea
DH.Gas3013.2	② RS232 Cable & Software	Ea
DH.Man3003.1	③ Tubing for 30psi Pressure / Vacuum and 8mm Lug, 50cm, Black	Ea

* **Units Conversion** : 1psi×6.8947=kpa, 1psi×68.947=mbar(hpa), 1psi×0.068966=bar, 1psi×51.71433=torr
1psi×70.038=cmH₂O, 1psi×51.715=mmHg, 1psi×16=oz/inch², 1psi×6890=pascal(pa)
* **Note!** : Exceeding Maximum Pressure will cause Permanent Sensor Damage !

**DAIHAN® Pocket Dual TEMP & SALINITY Pen-type Meter, Data Hold
With Large Display LCD for Salinity and Temp, 00.00~70.0ppt / 0~50.0°C, 휴대용 염분계**



Salinity Pen-type Meter

- * One Touch Auto-calibration & Calibration Values are Adjustable * Hold Function to Freeze Current Reading
- * Large Display LCD for Simultaneous Output of Salinity and Temperature (w18×h30 mm) * Water Proof (Ip65)
- * Quick Response & Auto Power off (20min / Disable) * Built-in NaCl conductivity to TDS Conversion Factor
- * Auto Temperature Compensation * Temperature unit °C/°F Selectable

Spec.	Model	DH.Sal3
2× Measuring Range		(1) Salinity : 0.00 ~ 10.0ppt(NaCl), 10.1 ~ 70.0ppt(NaCl), (2) Temp.: 0 ~ 50.0°C
2× Accuracy		(1) Salinity : ±1%F.S ±1digit, for 0 ~ 10.0ppt, ±2%F.S for 10.1 ~ 70.0ppt, (2) Temp.: ±0.5°C
2× Resolution		(1) Salinity : 0.01, for 0 ~ 10.0ppt, 0.1 for 10.1 ~ 70.0ppt, (2) Temp.: 0.1
Sensor life time / Battery		> 6 months (with Good Maintenance) / LR44×4pcs.
Dimension / Weight(g)		165×35×h32 mm (LCD Size : 30×18 mm) / 115g
Standard Package		Meter / Battery(LR44×4pcs) / Manual / Paper Box
Cat. No. & Price ₩		DH.Sal3003 Set



size : 191×53×53 mm

Protective Probe Cap

φ3×L.20mm



0°~180° Moving Head

φ5.1×L.120mm

Pocket Digital Thermometer "A1.T9233C"

**DAIHAN® Digital SOIL Thermometer, with 0~180° Moving Head
With large LCD Display, Pocket-type, -50°C + 300°C, 0.1°C, 토양 온도계, 180° 무빙헤드**

- * Unique Moving Head for Different Viewing Angle. * Large LCD Display with Digit Height 10mm.
- * Reduced Tip for Stronger Penetration Force. * Supplied with Protective Probe Cap.
- * 1 Second Normal Temperature Sensing Time. * CE Approval.

Spec.	Model	A1.T9233C
Dimension		191×53×53 mm (LCD Size : 37×13 mm)
Measurement Range		-50°C ~ +300°C or -58°F ~ +572°F
Resolution		0.1° for -19.9° ~ +199.9°, Otherwise 1°
Accuracy		±1.0°C or ±1.8°F In the Range of -30°C ~ +250°C or -22°F ~ +482°F, Otherwise more than ±2.0°C or ±4°F
Ambient Temperature		0°C ~ +50°C or +32°F ~ +122°F
Weight (g) / Color		40 / Black
Battery / Package		1×1.5 Volts "A76" Size (LR44, G13) or Equivalent / Sliding Blister with Print Card
Sensor Type		NTC-Probe : od.φ5/3×L120mm
Cat. No. & Price ₩		A1.T9233C Ea

DAIHAN® Portable Digital Sound Level Meter, 40~130dB, 0.1dB/1dB Resolution
With Digital Display (30×35mm) & Analog Bar Graph, 휴대용 소음계



Handy Digital Sound Level Meter

- * Used for Acoustic (sound that travels through air) Measurements, which had been widely used in the HVAC(Heating, Ventilation and Air Conditioning) or Other Industrial Related Application.
- * The Most Cost-effective Best Selling Meter
- * with Digital Display (30×35mm) and Analog Bar Graph
- * Pocket Size Fashion & Rigid Design
- * Auto / Manual Ranging, 4 Measurement Ranges in 10 Steps.
- * Fast /Slow Response is selectable.
- * A/C Weighting is selectable
- * Tripod Mountable
- * A weighting enables the meter to respond in the same manner as the human ear.
- * C weighting is suitable for flat response measurements with no increase or decrease of amplitude over the frequency spectrum.

Specifications & Ordering information

Spec.	Model	DH.Sou3
2× Measuring Range		(1) A Weight : 40dB ~ 130dB (2) C Weight : 45dB ~ 130dB
Accuracy at 94dB, 1KHz		± 2dB
2× Resolution		(1) Digital Display : 0.1dB, (2) Quasi-Analog Bar : 1dB
Digital / Quasi-Analog Display (4 Range)		40 ~ 70dB, 60 ~ 90dB, 80 ~ 110dB, 100 ~ 130dB
Digital-/ Bar Updating Time		160mS / 40mS
Microphone		Dia.6mm Electric Condenser Microphone
Battery / Battery Life Time		AAA×4pcs / 60 Hours Typical
Dimension / Weight(g)		57×230×44mm(LCD Size : 30×35mm) / 130g
Standard Package		Meter / Battery / Manual / Paper Box
Cat. No. & Price ₩	DH.Sou3003	Set

DAIHAN® Digital Sound Level Meter, with Deluxe Super Large LCD, IEC60651 Type 2 Class Certificated
With Max-Min / Backlight, 30dB~130dB, 세미 아날로그 디지털 소음계



Digital / Analog Sound Level Meter

- * Meet IEC60651, type2 Class Standard.
- * Using the Background Noise Absorber.
- * Deluxe Super Large LCD Display.
- * Easy to Calibrate by Standard Calibrator
- * AC/DC Analog Output
- * Auto/Manual Ranging, 6 Measurement Ranged in 10 Steps.
- * Professional and Rigid Design.
- * Freezing the Maximum Sound Level Reading.
- * Features w/Digital Display and Analog Bar Graph.
- * Easy to Replace Battery.
- * Max./Min. Recording.
- * A/C Weighting is Selectable.
- * Backlight Function to Use in Dark Area.
- * Automatic Shut off.
- * Tripod Mountable.

Specifications & Ordering information

Spec.	Model	DH.Sou5
2× Measuring Range		(1) A Weight : 30dB ~ 130dB (2) C Weight : 35dB ~ 130dB
Accuracy at 94dB, 1KHz		± 1.5dB
2× Resolution		(1) Digital Display : 0.1dB, (2) Quasi-Analog Bar : 1dB
Digital / Quasi-Analog Display (6 Range)		30 ~ 80dB, 40 ~ 90dB, 50 ~ 100dB, 60 ~ 110dB, 70 ~ 120dB, 80 ~ 130dB
Digital-/ Bar Updating Time		160mS / 40mS
Analog Output		AC 0.707Vrms(at Full Scale) ; DC 10mV/dB
Microphone		Dia.6mm Electric Condenser Microphone
Frequency Range		31.5Hz ~ 8KHz
Battery / Battery Life Time		9V Battery×1pcs. or 9VDC Adaptor / 30 Hours Typical
Dimension & Weight(g)		254×77×h37 mm (LCD Size : 42×62 mm) / 200g
Standard Package		Meter / Battery / Manual / Carry Case
Cat. No. & Price ₩	DH.Sou3005	Set



Hard Carrying Case



- Option ; DH.Gas3013.1 ① USB Cable & Software **Ea**
 DH.Gas3013.2 ② RS232 Cable & Software **Ea**

DAIHAN® Digital Pro-Tachometer, Contact & Non-Contact 2 in 1 Meter, 10~99999rpm
 With Red LED-Beam / Non-Contact, Concave / Convex-Contact Tips, 프로급 타코미터, 접촉/비접촉 겸용



Digital Pro-Tachometer

- * Non-Contact Measurement by Red Led Beam
- * Contact Rotation Object via Convex or Concave Contact Tips
- * Four Rotation Speed Units are Selectable in Contact Mode : rpm, m.min, ft/min, yd/min
- * Three Steps to Switch Operation Mode
- * Auto Power Off in 20mins inactivity

Specifications & Ordering information

Spec.	Model	DH.Tac3
3× Measuring Range		(1) Rotation (Non-contact) : 10.0 ~ 99999rpm (2) Rotation (Contact) : 10.0 ~ 19999rpm (3) Surface Speed (Contact) : 1.0000 ~ 9999.9M/Min.
Accuracy / Measuring Distance		± (0.1% of rdg. +2digit) / 5 ~ 30cm (Non-contact)
Resolution		rpm : 0.001 / 0.01 / 0.1 / 1, Others : 0.0001 / 0.001 / 0.01 / 0.1
Time Base & Sampling Time		4.0Mhz Quartz Crystal / 1sec.(> 60rpm), > 1sec.(10-60rpm)
Dimension / Weight(g)		165×51×h32mm (LCD Size : 15×33 mm) / 90g
Standard Package		Meter / Battery / Manual / Reflective Tape / Convex Tip / Concave Tip
Cat. No. & Price ₩	DH.Tac3003	Set

- Spare ; DH.Tac3003.1** ① Convex Tip for contact Rotate Speed Use **Ea**
DH.Tac3003.2 ② Concave Tip for contact Rotate Speed Use **Ea**
DH.Tac3003.3 ③ Reflective Tape for Non-Contact Rotate Speed, 16×600mm **Ea**

DAIHAN® Digital Pocket Tachometer, Contact or Non-Contact 2-type, 10~99999rpm
 Non-Contact type with Red LED-Beam, Contact type with Convex Tip or Concane Tip, 접촉식 or 비접촉식 타코미터



Non-Contact type (DH.Tac5)

Contact type(DH.Tac7)

- * Safe and Easy to Get Rotation Speed
- * Hold Function Freezes Current Reading
- * Four Rotation Speed Units are Selectable in Contact Mode : RPM, M/Min, Ft/Min, Yd/Min
- * Contact Type : Straight-line Contact with the Center of the Rotating Body
- * Non-contact Type : Reflective Tape Affixed to an Object and Measuring the Rotation. (50 to 150mm)
- * Auto Power off (20min / Disable)

Specifications & Ordering information

Spec.	Model	DH.Tac5	DH.Tac7
Measure Range		Rotation(Non-contact) : 10.0 ~ 99999rpm	Rotation(Contact) : 10.0 ~ 19999rpm, Surface Speed(Contact) : 1.000~9999.9M/Min
Accuracy		± (0.1% of rdg. +2digit)	
Resolution		rpm : 0.001 / 0.01 / 0.1 / 1, Others : 0.0001 / 0.001 / 0.01 / 0.1	
Measure Distance		5~30cm	Contact
Power Consumption / Time Base		5uA(Idle), 18mA(Measurement) / 4.0Mhz Quartz Crystal	
Sampling Time / LCD Size		1Second(> 60RPM), > 1Second(10~60RPM) / 33×h15mm	
Battery		1×9V Battery	
Dimension / Weight(g)		124×50×h33mm / ~80g	149×50×h33mm / ~85g
Standard Package		Meter / Battery / Manual / Paper Box / Reflective Tape / Convex Tip / Concave Tip	
Cat. No. & Price ₩	DH.Tac3005	Set	DH.Tac3007 Set

- Spare ; DH.Tac3003.1** ① Convex Tip for contact Rotate Speed Use **Ea**
DH.Tac3003.2 ② Concave Tip for contact Rotate Speed Use **Ea**
DH.Tac3003.3 ③ Reflective Tape for Non-Contact Rotate Speed, 16×600mm **Ea**

DAIHAN® Handy/Digital Thermo-Hygrometer, Rotary Sensor Protector, °C/°F & R.H%, Max/Min
 With Large LCD, Rubber Coated & Black Carrying Case, -50°C ~ +70°C, 20~99.9% R.H, 0.1 Divi, **포켓/디지털 온습도계**

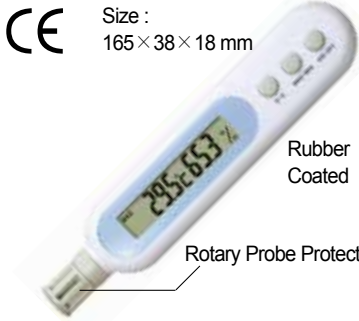

Size :
165 × 38 × 18 mm

Rubber Coated

Rotary Probe Protector

"A1.H9237"



with Black Case

- * Ideal for Storage Rooms, Pharmaceutical Rooms, Greenhouse, Laboratory, etc.
- * Pocket Size with Large LCD.
- * Rubber Coated.
- * Low Battery Indicator.
- * Rotary Sensor Protector Protects The Sensor when not in Use.
- * Battery Included.
- * Easy to Change Battery.
- * with Black Carrying Case.
- * CE Approval.

Specifications & Ordering information

Spec.	Model	A1.H9237
Measurement Range		-50°C ~ +70°C or -58°F ~ +158°F / 20% ~ 99.9% R.H (No Condensation)
Resolution		0.1° for Whole Range/ 0.1% R.H for Whole Range
Accuracy		±1.0°C or ±1.8°F In the Range of -0°C ~ +50°C or -4°F ~ +122°F, Otherwise more than ±1.0°C or ±1.8°F
Sensor Type		NTC & Humidity
Ambient Temperature		0°C ~ +50°C or +32°F ~ +122°F
Weight (g) / Color		55g / White
Battery / Package		1 × 3 Volts "CR 2032" Size or Equivalent / White Box
Dimension		165 × 37 × 18 mm (LCD Size : 58 × 12 mm)
Cat. No. & Price ₩	A1.H9237	Ea

DAIHAN® 2 & 3-row Jumbo Display Thermo-Hygrometer, for Indoor / Outdoor, °C/°F & R.H%
 With 3m Cord/Probe, Memory Recalling, -50~+70°C, 20~99.9% R.H, 0.1 Divi, **2 & 3열 실내·외 온습도계**



Size :
120 × 110 × 25 mm

(1) Jumbo 2-Row Display , "A1.H9213"



Stand & Hanger

- * Ideal for Office, Home, Greenhouse, Laboratory.
- * (1) Dual or (2) Triple Row Display for Easy Reading.
- * Comfortable and Uncomfortable Index (Comfort/Warm/Cool).
- * Jumbo LCD.
- * 3m Sensor Wire with Probe for Outdoor Temperature Measurement.
- * (1) Dual or (2) Triple Row Display for Easy Reading.
- * Temperature Unit °C/°F Selectable.

(1) With 2-Row Jumbo Display ; On/Off, °C/°F, Max/Min (°C/°F), Temperature and Humidity, Indoor Humidity Measurement Indoor/Outdoor Temperature Measurement, Memory Recalling.

Specifications & Ordering information

Spec.	Model	A1.H9213
Measurement Range		-50°C ~ +70°C or -58°F ~ +158°F / 20% ~ 99.9% R.H (No Condensation)
Resolution		0.1° for Whole Range/ 0.1% R.H for Whole Range
Accuracy		±1.0°C or ±1.8°F In the Range of -20°C ~ +70°C or -4°F ~ +158°F, Otherwise more than ±1.0°C or ±1.8°F
Ambient Temperature		0°C ~ +50°C or +32°F ~ +122°F
Weight (g) / Color		165g / White
Battery / Package		2 × 1.5 Volts "AAA" Size or Equivalent / Sliding Blister with Print Card
Sensor Type		NTC & Humidity External Sensor : 3m Sensor Wire with Probe(L22.5 × φ5.5mm)
Dimension		120 × 110 × 25 mm (LCD Size : 72 × 61 mm)
Cat. No. & Price ₩	A1.H9213	Ea



Size :
120 × 110 × 25 mm

(2) Jumbo 3-Row Display , with Alarm Timer "A1.H9216"



Stand & Hanger

(2) With 3-Row Jumbo Display, with Alarm Timer ; On/Off, °C/°F, Max/Min (°C/°F), Temperature and Humidity Memory Recalling, Clock (HH/MM/SS), Alarm/Snooze Set, 12hr or 24hr Format Selectable, Indoor/Outdoor Temperature Measurement, Indoor Humidity Measurement.

Specifications & Ordering information

Spec.	Model	A1.H9216
Measurement Range / Alarm Timer		-50°C ~ +70°C or -58°F ~ +158°F / 20% ~ 99.9% R.H (No Condensation) Alarm Timer Function
Resolution		0.1° for Whole Range/ 0.1% R.H for Whole Range
Accuracy		±1.0°C or ±1.8°F In the Range of -20°C ~ +70°C or -4°F ~ +158°F, Otherwise more than ±1.0°C or ±1.8°F
Ambient Temperature		0°C ~ +50°C or +32°F ~ +122°F
Weight (g) / Color		165g / White
Battery / Package		2 × 1.5 Volts "AAA" Size or Equivalent / Sliding Blister with Print Card
Sensor Type		NTC & Humidity External Sensor : 3m Sensor Wire with Probe(L22.5 × φ5.5mm)
Dimension		120 × 110 × 25 mm (LCD Size : 72 × 61 mm)
Cat. No. & Price ₩	A1.H9216	Ea

DAIHAN® Desktop / Wallmount Dew-point Thermo-Hygrometer of Temp / RH% / DP°C, Max/Min, Hold Programmable Danger Zone, Alarm 65dB, Time Clock, 0~50°C, 20~90% RH, -20+70°C DP, 탁자 / 벽걸이용 이슬점 온습도계



B. SD-Card Logging Dew-point Thermo-Hygrometer



(DH.Thh9 only)

- * Simultaneously Displays Temperature and Humidity
- * Check Humidity Condense Conditions Through Dew Point
- * Real Time Display(Hour & Minute, AM/PM)
- * Audible Beeper and Bright Red Led for Danger Zone Warning
- * Designed with Capacitance type humidity Sensor to Get Accurate and Quick Reading
- * Advanced SD Card Logging Design for Continuous Recording(DH.Thh9 only)
- * Temperature Unit °C/°F Switchable
- * Max/Min Function to Review Data
- * Programmable Danger Zone for Warning Purpose
- * Long Battery Life One year Via Alkaline Battery

Specifications & Ordering information

Spec.	Model	A. DH.Thh7	B. DH.Thh9
3× Measuring Range		(1) Temp.: 0 ~ 50°C (display : -10.0 ~ 70.0°C), (2) Humidity : 20 ~ 90%RH (Display : 0% ~ 99.9%RH), (3) Dew Point : -20 ~ 70°C	
2× Accuracy		(1) Temp.: ± 1°C, (2) Humidity: ± 5%RH (at 25°C, 10 ~ 90%RH, other ± 7%RH)	
2× Resolution		(1) Temp.: 0.1°C/°F, (2) Humidity : 0.1%RH	
Temp. Response Time		2 mins	
SD Card		-	Max. 2GB SD Card or 4GB SDHC Card
Battery		3× AA Battery	3× 1.5Volts AA Battery or 5V Adaptor
Dimension / Weight(g)		110×91×h30mm(LCD Size : 63×70 mm) / 200g	
Standard Package		Meter / Battery / Manual / Paper Box	Meter / Adaptor / Manual / Paper Box / 256MB SD Card
Cat. No. & Price ₩		DH.Thh3007 Ea	DH.Thh3009 Ea

DAIHAN® Temp °C/°F & RH% USB Datalogger with PDF Report, -30+70°C, 0.1~99.9% RH Auto-Generate a PDF & Excel Report while Plugged into PC, Programmable by Users, 온습도 측정 및 Data 로거



USB Datalogger

- * Software & Driver are not required for any operation
- * Only 3 Steps to Operate : ① Plug to program ② Press Start to Activate ③ Plug again to Generate PDF/Excel report
- * Completely Programmable by Users for Maximum Flexibility includes : 6 Languages, Sampling Interval, Start Delay, Alarm Delay, Unit, Alarm Range, Alarm Type, Password and User Name
- * Designed with Comprehensive Usage with Waterproof Function(IP 67)
- * High Accuracy Thermistor and Capacitive RH Sensor
- * EN12830 and RoHS Compliance

Specifications & Ordering information

Spec.	Model	DH.Thh3	
		Temperature	Humidity
Measure Range		NTC Thermistor, -30~70°C, -22~158°F	Capacitor, 0.1 ~ 99.9%RH
Accuracy		± 0.5°C	± 3% (at 25°C, 10 ~ 90%), others ± 5%
Resolution		0.1°C / 0.1°F	0.1%RH
Battery		2× CR2032(3.0 V) Battery	
Dimension / Weight(g)		110×45×h17mm / 80g	
Standard Package		Logger / Manual / Paper Box	
Cat. No. & Price ₩		DH.Thh3003	Set

DAIHAN® Temp/Humidity/Barometric Bluetooth Datalogger, -30+70°C, 0.1~99.9% RH, 300~1100hPa NEW Generate PDF & Excel Report Through APP, Real Time Check without Stopping, 온습도 및 기압 Data 로거



Bluetooth Datalogger

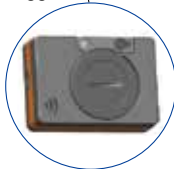

- * Programming Logger & Download Data Wirelessly Through Advanced Bluetooth 4.0 Technology
- * Generate and Send Out PDF Report Through APP. Report Contains Data Summary, Graph and Detailed Data
- * Check Real Time Data on APP Anytime Download Data to APP without Stopping Recording.
- * Designed with Comprehensive Usage with Waterproof Function(IP 65)
- * Please Search for "Nice Logger" in APP Store.
- * EN12830 and RoHS Compliance

Specifications & Ordering information

Spec.	Model	DH.Thh15		
		Temperature	Humidity	Barometric
Measure Range		NTC Thermistor, -30~70°C, -22~158°F	Capacitor, 0.1 ~ 99.9%RH	300~1100hPa 8.9~32.5inHg
Accuracy		± 0.5°C	± 3% (at 25°C, 10 ~ 90%), others ± 5%	± 3hPa(0~60C), ± 5hPa(-20~0C)
Resolution		0.1°C / 0.1°F	0.1%RH	0.1hPa, 0.1inHg
Ambient Temp.		-30~70°C, (Humidity < 90%)		
Battery		CR2(3.0 V) Battery× 1pc		
Dimension / Weight(g)		70×50×h23mm (Body), 30×18(LCD)/ 80g		
Standard Package		Logger / Manual / Paper Box / Battery		
Cat. No. & Price ₩		DH.Thh3015	Ea	

DAIHAN® Pocket Dew-point Thermo-Hygrometer of Temp / RH% / DP°C / WB°C, Max/Min, Hold
 Optional External Temp Probe(-20+70°C), -20+50°C, 0~100% RH, -78.7+50°C DP, 포켓 다기능 이슬점 온습도계



- * Designed with Capacitance-type Humidity Sensor to get Accurate and Quick Reading
- * Simultaneously Triple Display Temp. / RH% / External Probe Temp
- * Maximum / Minimum and Reset function
- * External Probe for Checking Food Quality & HVAC/R Applications
- * Temperature unit °C/°F Selectable
- * Auto Power Off time frame Selectable
- * Hold function to Freeze current Reading

Specifications & Ordering information

Spec.	Model	DH.Thh5	
4× Measuring Range		(1) Temp. : -20 ~ 50°C, (2) Humidity : 0%RH ~ 100%RH, (3) Dew Point : -78.7 ~ 50.0°C, (4) Wet Bulb : -21.6 ~ 50.0°C	
2× Accuracy		(1) Temp. : ±0.6°C, (2) Humidity : ±3%RH (at 25°C, 10 ~ 90%RH, other ±5%RH)	
2× Resolution		(1) Temp. : 0.1°C/°F, (2) Humidity : 0.1%RH	
Battery		2×AAA Battery	
Dimension / Weight(g)		48.4 × 178.5 × h24.7mm(LCD Size : 28 × 33 mm) / 100g	
Standard Package		Meter / Battery / Manual / Paper Box	
Cat. No. & Price ₩	DH.Thh3005		Set
Option ; DH.Gas3007.1	① Cal. Salt Bottle for Calibration, 33%, 56ml		Ea
DH.Gas3007.2	② , 75%, 56ml		Ea
DH.Thh3005.1	③ External Temp. Probe, 116cm, with Handle		Ea

DAIHAN® Handy Dew-point IR Thermo-Hygrometer for Air & Surface Temp / RH% / DP°C
 Built in Laser-Beam, Backlight, PC Data Analysis, -40+500°C IR, 0~100% RH, -68+49.9°C DP, 휴대용 IR 온습도계



- * The Most Popular IR+ Humidity Two in One Meter
- * Consist of ; Meter, Battery, Manual, Carry Case
- * Triple Display Measures Air/Surface Temp. & Humidity
- * Design with Precision Humidity Sensor
- * Gear Damper Device (Design Patent) for Sensor Protection
- * Auto Power off Time Adjustable
- * IR Emissivity Value Adjustable 0.3~1.0
- * Built-in Laser Beam (670nm) for Targeting
- * Powered by 4pcs AAA Batteries
- * Temperature Unit °C/°F is Switchable
- * Laser Beam & Backlight Function Selectable
- * PC Output Data Download

Specifications & Ordering information

Spec.	Model	DH.Thh11		
Measure Range		-40 ~ 500°C	-20 ~ 50°C	0 ~ 100%RH
Resolution		0.1°C / 0.1°F	0.1°C / 0.1°F	0.1%RH
Accuracy		±2°C at 20 ~ 200°C, Others is ±3°C	±0.6°C	±3%RH (at 25°C, 10 ~ 90%RH, others ±5%RH)
3× Measuring Range		(1) IR Temp.: -40 ~ 500°C, (2) Temp.: -20 ~ 50°C, (3) Humidity : 0 ~ 100%RH		
3× Accuracy		(1) IR Temp.: ±2°C at 20 ~ 200°C, Others is ±3°C, (2) Temp: ±0.6°C, (3) ±3%RH (at 25°C, 10 ~ 90%RH, others ±5%RH)		
3× Resolution		(1) IR Temp.: 0.1°C/°F, (2) Temp.: 0.1°C/°F, (3) Humidity : 0.1%RH		
Dew Point & Wet Bulb Temp.		-68 ~ 49.9°C & -21.6 ~ 49.9°C		
IR Repeatability		±1°C		
Emissivity		0.3 ~ 1.0 adjustable		
Dimension / Weight(g)		70 × 50 × h175mm(LCD Size : 44 × 26 mm) / 140g		
Standard Package		Meter / Battery / Manual / Carry Case		
Cat. No. & Price ₩	DH.Thh3011			Ea
Option ; DH.Gas3013.1	① USB Cable & Software			Ea
DH.Gas3013.2	② RS232 Cable & Software			Ea

DAIHAN® Compact Gun type IR(infrared) Thermometer, Comply with FDA Standard Class II, Temp -40°C ~ +500°C With Ergonomic Hand Grip, °C/°F 비접촉 적외선(IR) 온도계



Gun type IR Thermometer

Soft Carry Case (Option)

- * Built in Laser Beam(670nm, <1mw) for Targeting.
- * Adjustable Emissivity from 0.3 to 1.0 for Metal and Non-Metal Surface Measurement.
- * Quick and accurate IR Response Time : 500ms.
- * Product Complies with FDA Standard Class II

Specifications & Ordering information

Spec.	Model	DH.The13
Measurement Range		-40°C ~ +500°C
Temp Accuracy		±2% or ±2°C at -20°C ~ +200°C, others ±3% or 3°C
Resolution		0.1°C/°F for -40°C ~ +110°C, 1°C/°F for others
Repeatability / Distance Ratio		±1°C / 10 : 1
Battery		1×9V Battery
Dimension & Weight(g)		80×45×h157 mm (LCD Size : 21.8×31.8 mm) / 140g
Standard Package		Meter / Battery / Manual / Paper Box
Cat. No. & Price ₩	DH.The3013	Set
Option ; DH.The3013.1	Soft Carry Case(Pouch), Black for DH.The3013	Ea

DAIHAN® Waterproof IP65 IR(infrared)+Contact Pt-Probe Thermometer, with Laser-pointer, MAX/MIN With 180° Rotary Piercing Probe 8cm / Timer / Data-hold / °C / °F, -40°C+280°C/0.1°C, 접촉+비접촉 겸용 IR 온도계

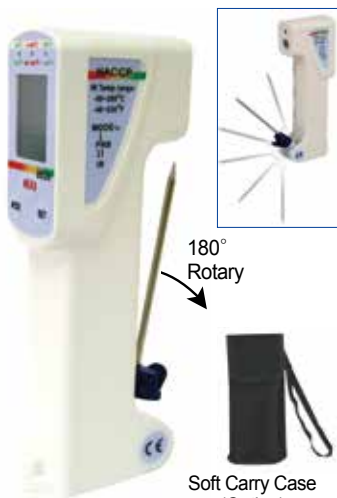

Waterproof IR & Probe Thermometer

180° Rotary

Soft Carry Case (Option)

- * Follow HACCP Principle to Check Food Safety
- * IP65 Waterproof Targeting, Washable Probe
- * Quick to Inspect Danger Zone Temperature
- * Big LCD with Backlight to Display Measured Temperature
- * Flip over Probe for Internal Temperature Measurement
- * Built-in Laser to Highlight the Area
- * Certified HACCP
- * Temperature Unit C/ F is Switchable
- * Auto Power off in 20 mins Inactivity
- * Quick and Accurate IR Response Time : 500ms
- * Count down Timer Ensure Food Safety Storage
- * Max Reading Displays while in IR Scanning Status

Specifications & Ordering information

Spec.	Model	DH.The15
2× Measuring		(1) IR Temp. : -40 ~ +280°C, (2) Probe Temp : -40 ~ +200°C
Accuracy		(1) IR Temp.: [<0°C(32°F)]: +/-1°C(2°F) +/-0.1, [0~65°C(32~150°F)]: +/-1°C(2°F), [>65°C(150°F)]: +/-1.5% of rdg, (2) Probe Temp.: [<-5°C(23°F)]: +/-1°C(2°F) [>65°C(150°F)]: +/-1°C or 1.5% of rdg, [-5 ~ 65°C(23 ~ 150°F)]: +/-0.5°C(1°F)
Resolution		(1) IR Temp.: 0.1°C/°F, (2) Probe Temp.: 0.1°C/°F
D:S ratio / IR Repeatability / Emissivity		3:1 / ±1°C / 0.97
Battery		1×9V Battery or Adaptor
Dimension / Weight		61.5×35.5×167 mm (LCD Size : 21×28mm) / 140g
Standard Package		Meter / Battery / Manual / Paper Box
Cat. No. & Price ₩	DH.The3015	Set
Option ; DH.The3015.1	Soft Carry Case(Pouch) 176×75×h35mm, Black for DH.The3015	Ea

DAIHAN® High Temp IR(Infrared) Thermometer, with Large LCD & Laser-pointer, Temp -40°C ~ +816°C With Wrist Strap & Hard Carry Case & Soft Carrying Pouch, °C/°F 비접촉 적외선(IR) 온도계



High Temp IR(Infrared) Thermometer

Hard Carrying Case

Soft Carrying Pouch

- * Built in Laser Beam(670nm, <1mw) for Targeting.
- * Quick and accurate IR Response Time: 500ms.
- * Rubber-Like Hand Grip Design.
- * Large LCD w/ Backlight Function.
- * Adjustable Emissivity from 0.3 to 1.0
- * Easy Flip Battery Compartment Design.

Specifications & Ordering information

Spec.	Model	DH.The17
Measurement Range		-40°C ~ +816°C
Temp Accuracy		< 0°C : ±2°C / 0°C ~ 300°C : ±2% or ±2°C 300°C ~ 500°C : ±2.5% / > 500°C : ±3%
Resolution		0.1°C/°F(<300°C), 1°C/°F(>300°C)
Distance Ratio / Battery		12 : 1 / 2×AA Battery
Dimension & Weight(g)		195×134×h50 mm (LCD Size : 34×37 mm) / 240g
Standard Package		Meter / Battery / Manual / Hard Carry Case / Wrist Strap / Soft Carrying Pouch
Cat. No. & Price ₩	DH.The3017	Set
Spare ; DH.The3017.1	Soft Carry Case(Pouch) 200×133×h42mm, Black for DH.The3017	Ea

DAIHAN® IP67 Waterproof Digital Thermocouple Thermometer, with K-Probe

With 10 Sets Memories Data Storage, Recalling & Clearing, $-100^{\circ}\text{C} + 800^{\circ}\text{C}$, 방수 / 휴대용 1채널 디지털 온도계



Digital Thermocouple Thermometer

- * Max/Min ($^{\circ}\text{C}/^{\circ}\text{F}$) Memory Recalling. * EL Backlight for Use in Dim Light Environment.
- * Alerting Alarm Beeps when Temperature Reaches/Beyond the Pre-set Limit
- * Built in Holster with Flip Out Stand at the Back of the Unit. * Low Battery Indicator

Specifications & Ordering information

Spec.	Model	A1.TC9227A
Measurement Range		$-100^{\circ}\text{C} \sim +800^{\circ}\text{C}$ or $-148^{\circ}\text{F} \sim +1472^{\circ}\text{F}$
Resolution & Accuracy		0.1°, and $\pm 2^{\circ}\text{C}$
Water Proof & Weight		IP67 and 185g(only main unit) / Grey&Yellow
Battery		3 × 1.5Volts "AAA" Size or Equivalent
Sensor Type		K - Probe : od. $\phi 3.5 \times \text{L}110\text{mm}$ Plastic Handle : od. $\phi 17 \times \text{L}165\text{mm}$, Cable : od. $\phi 4 \times \text{L}1050\text{mm}$
Dimension		54 × 165 × 25 mm (LCD Size : 32 × 23 mm)
Cat. No. & Price ₩		A1.TC9227A Ea

DAIHAN® Portable Digital 2-Channel Thermocouple Thermometer, K / J / E / R / T / N / S-Type Probe Acceptable

With $\Delta T = T_1 - T_2$ / Max-Min / Avg / Memory, Without Probe, $-200^{\circ}\text{C} \sim +1370^{\circ}\text{C}$, 0.1 Divi., 휴대용 2채널 디지털 온도계



Self-Standing



Multiple Thermocouple (Type K, J, T, E, N, R, S) Compatible

- * 2 Channel Reading (T1 & T2). * Differential Temperature Measurement ($\Delta T = T_1 - T_2$).
- * 30 Sets Data Storage * 7" Large LCD with Function Indicators and Backlight.
- * Alarm Beeps when Temperature Reaches/ Beyond/ The Pre-Set Limit. * Audible Alarm.
- * Optional PVC Holster with Flip Out Stand at the Back of the Unit. * Low Battery Indicator.

Specifications & Ordering information

Spec.	Model	A1.T9214T
Measurement Range		K-Type : $-200^{\circ}\text{C} \sim +1370^{\circ}\text{C}$ or $-328^{\circ}\text{F} \sim +2498^{\circ}\text{F}$, Clock-Timer, Alarm
Resolution		0.1° for Whole Range
Accuracy		$\pm 0.05\%$ of Reading $+0.3^{\circ}\text{C} (+0.5^{\circ}\text{F})$ Below $-100^{\circ}\text{C} (+148^{\circ}\text{F})$; Add 0.15%
Ambient Temperature		$0^{\circ}\text{C} \sim +50^{\circ}\text{C}$ or $+32^{\circ}\text{F} \sim +122^{\circ}\text{F}$
Weight (g) / Color		310 / Yellow-Grey
Battery / Package		Battery Included ; 4 × 1.5Volts "AAA" Size or Equivalent / White Box
Sensor Type		Type K, J, E, T, N, R, S Thermocouple Acceptable ; Not Include
Dimension		81 × 172 × 33 mm (LCD Size : 59 × 35 mm)
Cat. No. & Price ₩		A1.T9214T ; Without Probe Ea

* Option ; K-Probes \Rightarrow See the 154 Page.

DAIHAN® RS232 / PC Data Analysis Thermometer, with Dual Input & Multiple-Type Probe, Compatible

With Time Clock / Backlight, K / J / T / R / S / E-Probe in Use, $-200 \sim +1370^{\circ}\text{C}$ in K-Type, 2채널 다기종 센서 수용 온도계



- * Non Sleep Mode Function available, Unit $^{\circ}\text{C}/^{\circ}\text{F}$ is Switchable, Super Big LCD for easy Reading.
- * RS232 interface for PC download, Data records stamped with real time clock, Backlight for dark area operation.

Specifications & Ordering information * Hold Function to Freeze Current Reading

Spec.	Model	DH.The7
6 × Measuring Range		(1) K-temp.: $-200 \sim 1370^{\circ}\text{C}$, (2) J-temp.: $-200 \sim 760^{\circ}\text{C}$, (3) T-temp.: $-200 \sim 390^{\circ}\text{C}$, (4) R-temp.: $0 \sim 1760^{\circ}\text{C}$, (5) S-temp.: $0 \sim 1760^{\circ}\text{C}$, (6) E-temp.: $-200 \sim 736^{\circ}\text{C}$
Accuracy		(1) K- / (2) J- / (3) T- / (6) E-temp.: $\pm (0.1\% \text{rdg} + 0.7^{\circ}\text{C})$ (4) R- / (5) S-temp.: $\pm (0.3\% \text{rdg} + 0.7^{\circ}\text{C})$
Resolution		(1) K-temp.: 0.1°C for $-200 \sim 650^{\circ}\text{C}$, 1°C for $640 \sim 1370^{\circ}\text{C}$, (2) J-temp.: 0.1°C for $-200 \sim 500^{\circ}\text{C}$, 1°C for $490 \sim 760^{\circ}\text{C}$, (3) T-temp.: 0.1°C for $-200 \sim 390^{\circ}\text{C}$, etc.
Battery		9V × 1pc or Adaptor
Dimension / Weight(g)		182 × 72 × h30 mm (LCD Size : 30 × 51 mm) / 150g
Standard Package		Meter / K Bead Probe / Battery / Manual
Cat. No. & Price ₩		DH.The3007 Set
Spare ;	DH.The3007.1	① 4m K-Bead Thermocouple Ea
Option ;	DH.Gas3013.1	② USB Cable & Software Ea
	DH.Gas3013.2	③ RS232 Cable & Software Ea
	DH.The3007.2	④ Rubber Holster, Blue Ea

DAIHAN® Wallmount / SD-card Logging 4-Channel K-type Thermometer, -200°C ~ +1370°C
 Ultimated Auto-Logging Memories in SD-card, with 2 Bead K-Probe/Alarm & Time Clock, 벽걸이 4채널 SD로거/온도계



SD-Card Logging K-type Thermometer

▶ **No-Bothering Computer Setting! Auto-Log Anytime/Anywhere!**

- * Super Big LCD Portable / Wallmount SD-card Logger Measures Temperature via K-type Thermometer
- * Hold Function Freezers Current Readings, Checking Max / Min Value from Power On
- * One Button Press to Display T1-T2, Display Temperature Change from Baseline
- * Blue Backlight
- * 12/24 hour Timer

Specifications & Ordering information

Spec.	Model	DH.The9
K temp range / Resolution		-200 ~ 1370°C, -328 ~ 2498°F / 0.1°C, 0.1°F
K temp accuracy		±(0.3% rdg +1°C)
Sampling rate		Programmable from 1 second up
Battery		4× AA Battery 9V adaptor ; Low Battery Indicator
Dimension / Weight(g)		152×100×h39mm(LCD Size : 47×104 mm) / 300g
Standard Package		Meter / 2× Bead Probe / Battery / Manual / SD-card / Plain Box
Cat. No. & Price ₩	DH.The3009	Set
Option ; DH.The3009.1	① 1m K-Bead Thermocouple	Ea
DH.The3009.2	② Universal Plug 9V Adaptor	Ea

DAIHAN® Foldable / Portable Digital Multi-Thermometer-Set, with 4 K-type Probe
 With 180° Moving Probe Connector, Timer(Count Up), -200°C ~ +1370°C, 0.1 Divi.
 With 4 K-Probe for Air / Immers. / Penetrat. / Surface, 휴대용 접이식 디지털 온도계 세트



Foldable/Portable Digital Multi-Thermometer-Set

■ **Ideal for Multi-use with Multi-Function in Lab & Industry**

- * Unique Feature of Folding Probe
- * Probe Connector is Adjustable Through 45°, 90°, 135°, 180°
- * Comprehensive and Variety Use
- * Four Probes Included for Different Measurement (e.g. Surface, Semi-Solid, Air)
- * Extra Carrying Box for Easy and Protective Storage
- * Four Probes Included
- * Large LCD
- * Easy to Operate
- * CE Approval
- * Battery Included
- * High Degree of Accuracy

Function : On/Off, Hold/Test, °C/°F, Max/Min (°C/°F) Memory Recalling, and Timer.

Specifications & Ordering information

Spec.	Model	A1.T9218
Measurement Range		-200°C ~ +1370°C or -328°F ~ +2498°F, Timer
Resolution		0.1° for Whole Range
Accuracy		±1.0°C or ±1.8°F In the Range of -49°C ~ +740°C or -56.2°F ~ +1364°F, Otherwise more than ±2.0°C or ±4°F
Ambient Temperature		0°C ~ +50°C or +32°F ~ +122°F
Weight (g) / Color		80 / Black
Battery / Package		2×3Volts "CR 2032" Size or Equivalent / Black Carrying Case
Sensor Type		Included 4× Type K Thermocouple
Dimension		153×50×19 mm (LCD Size : 50×22 mm)
Cat. No. & Price ₩	A1.T9218	Ea
Spare ; A1.TK069T	① Surface Probe, K-type	Ea
; A1.TK066A	② Airflow Probe, K-type	Ea
; A1.TK148O	③ Immersion Probe, Round, K-type	Ea
; A1.TK133S	④ Penetration Probe, K-type	Ea



Female Minisocket

Digital Temp Controller / Displayer for K-type Probes
 With Female Minisocket for Miniplug, -50°C +400°C, 디지털 온도측정 / 조절계

■ **Made in Korea**

■ **Ideal for Temp Control of Reactor-system**

- * Ideal for Temperature Monitor / Controller for Reactor System
- * With K-type Probe Connector & Electronic Cable 2m
- * Jumbo LCD with Digit Height 18mm
- * Dimension : 90×70×h50mm
- * 100~240VAC Free
- * High Accuracy

※ **Note : The Controller Can be used in other Cable & Plug System.**

SL.The5011 Digital Temp. Controller/Displayer-Set, -50°C~+400°C, K-type

Ea.	Price, ₩

Cowie® K-type PTFE Encapsulated Stainless-steel Thermocouple Probe, Can be Bent, -180°C +280°C
 With Miniplug & PFA Insulated 1m & 2m Cable, Probe Body L100~900mm, PTFE 내약품 / 내부식 / 청결형 온도 프로브



■ **Made in UK.**

■ **Ideal for Reactor : Especially Long Body Probes**

- * Outstanding Chemical Resistance, No-Contamination of Working Media, and Pressure Resistant
- * Fully Pure PTFE Encapsulated Stainless-steel Core Probe for Rigidity, But can be Bent
- * with Push-On Ferrule
- * Response : 50% in 6~14 seconds, -180°C+280°C

(1) With L100~L700mm Probe-body and 1m Cable

Cat. No.	Probe Body	Ferrule	Total Length
CW.600.101.1	PTFE Capsulated K-probe, Body- $\phi 6 \times L100$	L35mm	Total -L135mm
CW.600.201.1	- $\phi 7 \times L200$	-L40mm	-L240mm
CW.600.301.1	- $\phi 8 \times L300$	-L40mm	-L340mm
CW.600.401.1	- $\phi 8 \times L400$	-L50mm	-L450mm
CW.600.501.1	- $\phi 9 \times L500$	-L60mm	-L560mm
CW.600.601.1	- $\phi 9 \times L600$	-L60mm	-L660mm
CW.600.701.1	- $\phi 9 \times L700$	-L45mm	-L745mm

Ea. Price, ₩

(2) With L900mm Probe-body and 2m Cable

CW.600.901.1.2	PTFE Capsulated K-probe, Body- $\phi 9 \times L900$	Ferrule-L45mm	Total-L945mm
----------------	---	---------------	--------------

Ea. Price, ₩

K-type Thermocouple Probe, for Wide-range Temp. -160°C ~ +1200°C
 With Common use Plug "Miniature 2 Flat" and Cable, "K-형" 온도계 & 각종 열기구 온도 프로브

- **K-Type Sensor Probes for Different Applications (Penetration Probe, Surface Probe, Pipe Clamp)**
- **Miniature 2 Flat (L14×Thick 1mm) Plug Type**

■ **Cable : od. $\phi 3 \times L1020$ mm**

■ **Handle : Thermo Plastic od. $\phi 17 \times L170$ mm**

(1) For Liquid & Air, Stainless-steel Probe, Resin Handle with Cable/Plug, -160°C ~ +1200°C

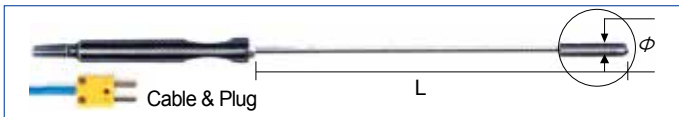

AS1.5522.04	Liquid/ Air Probe "K", -160 ~ +700°C, $\phi 1.0 \times L306$ mm, 1m Cable/Plug
DH.WHP503040	, -60 ~ +600°C, $\phi 4.8 \times L250$ mm, 1.8m Cable/Plug
DH.WHP503050	, -60 ~ +500°C, $\phi 4.8 \times L380$ mm, 1.8m Cable/Plug

Ea. Price, ₩

(2) For Semi - solid Penetration-type, Stainless-steel Probe, Resin Handle with Cable/Plug, -100°C ~ +1000°C

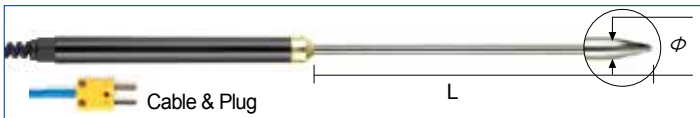

A1.TK175S	Penetration Probe "K", -100 ~ +800°C, $\phi 3.2 \times L150$ mm, 1m Cable/Plug
A1.TK225S	, -100 ~ +1000°C, $\phi 6.4 \times L200$ mm, 1m Cable/Plug

Ea. Price, ₩

(3) For Surface / Contact, Stainless-steel Probe, Resin Handle with Cable/Plug, -100°C ~ +400°C

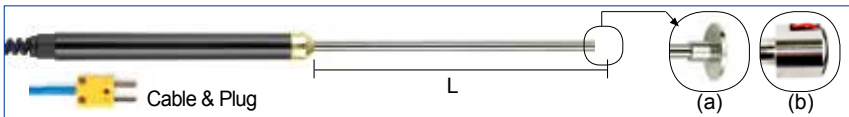

A1.TK004T	(a) Surface Probe "K", Head : $\phi 15 \times t1.5$, Stem : $\phi 3.5 \times L180$ mm, -100 ~ +400°C, 1m Cable/Plug
A1.TK033T	(b) : $\phi 16 \times t14$, Stem : $\phi 6.5 \times L215$ mm, -100 ~ +400°C, 1m Cable/Plug

Ea. Price, ₩

(4) Pipe Clamping Probe, with Cable Plug, -100°C ~ +120°C

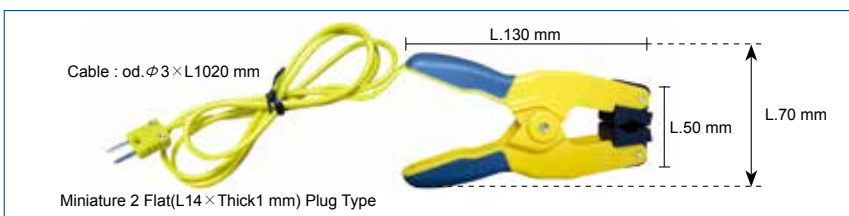

A1.TK0063	Pipe Clamp Probe, Pipe / Tubing, $\phi 6 \sim 22$ mm Grip -100°C ~ +120°C
-----------	---

Ea. Price, ₩

DAIHAN® IP67 Waterproof Digital Thermocouple Thermometer, with 1 NTC-Probe

With 10 Sets Memories Data Storage, Recalling & Clearing, -50°C ~ +300°C, 방수 / 휴대용 1채널 디지털 온도계



Unit size :
77 × 172 × 46 mm

- * Max/Min (°C/°F) Memory Recalling.
- * Alerting Alarm Beeps when Temperature Reaches/Beyond the Pre-set Limit
- * EL Backlight for Use in Dim Light Environment.
- * Supplied with Sensor Probe and Plastic Handle Assembled Together
- * PVC Holster with Flip Out Stand at the Back of the Unit.
- * 1 Second Normal Temperature Sensing Time.
- * Optional One Hour Auto Shut Off
- * CE Approval.
- * Low Battery Indicator.

Specifications & Ordering information

Spec.	Model	A1.T9234
Measurement Range		-50°C ~ +300°C or -58°F ~ +572°F
Resolution		0.1° for -19.9° ~ +199.9°, Otherwise 1°
Accuracy		±1.0°C or ±1.8°F In the Range of -30°C ~ +250°C or -22°F ~ +482°F Otherwise more than ±2.0°C or ±4°F
Ambient Temperature		0°C ~ +50°C or +32°F ~ +122°F
Weight (g) / Color /Water Proof		280 / Grey · Yellow / IP 67
Battery / Package		2 × 1.5Volts "AAA" Size or Equivalent / White Box
Sensor Type		NTC Probe : od.φ3.5 × L110mm Plastic Handle : od.φ17 × L120mm, Cable : od.φ4 × L1450mm
Dimension		77 × 172 × 46 mm (LCD Size : 51 × 32 mm)
Cat. No. & Price ₩	A1.T9234	Ea

DAIHAN® IP67 Waterproof Digital 2-Channel Thermocouple Thermometer, with 2 NTC-Probe

With 10 Sets Memories Data Storage, Recalling & Clearing, 50°C ~ +300°C, 방수 / 휴대용 2채널 디지털 온도계



Unit size :
77 × 172 × 46 mm

- * Convenient Function for Calculating Differential Temp-Measurement ($\Delta T = T1 - T2$).
- * Alerting Alarm Beeps when Temperature Reaches/Beyond the Pre-Set Limit
- * 1 Second Normal Temperature Sensing Time.
- * Low Battery Indicator.
- * CE Approval.
- * EL Backlight for Use in Dim Light Environment.
- * Universal Kit Set with Two Stainless-steel Probes Together.

Specifications & Ordering information

Spec.	Model	A1.T9234T
Measurement Range		-50°C ~ +300°C or -58°F ~ +572°F
Resolution		0.1° for -19.9° ~ +199.9°, Otherwise 1°
Accuracy		±1.0°C or ±1.8°F In the Range of -30°C ~ +250°C or -22°F ~ +482°F Otherwise more than ±2.0°C or ±4°F
Ambient Temperature		0°C ~ +50°C or +32°F ~ +122°F
Weight (g) / Color /Water Proof		280 / Grey · Yellow / IP 67
Battery / Package		2 × 1.5Volts "AAA" Size or Equivalent / White Box
Sensor Type		NTC Probe : od.φ3.5 × L110mm Plastic Handle : od.φ17 × L120mm, Cable : od.φ4 × L1450mm
Dimension		77 × 172 × 46 mm (LCD Size : 51 × 32 mm)
Cat. No. & Price ₩	A1.T9234T	Ea

DAIHAN® NTC-type Probe, for NTC-type Thermocouple Thermometer

- (1) Penetration Probe : Suitable Semi-Solid, Liquid, Air-Temperature.
- (2) Surface Probe : Superior Contact, Plate-Temperature.
- (3) Robust Piercing Probe : Stronger Penetration Force, Rapid Response Time, Suitable for Frozen Food.

Cat. No.	Dimension	Temperature °C / °F / Others	Ea. Price, ₩
(1) A1.TN0300	4Pin(Pole) Plug(φ38 × L39 mm), Cable : od.φ4 × L.1450 mm with Protective Probe Cap Handle : Thermo Plastic od.φ17 × L.120 mm od.φ5.0 × L.275 mm	Penetration, -50°C ~ +300°C / -58°F ~ +572°F, Very Sharp Tip	
(2) A1.TN133T	4Pin(Pole) Plug(φ38 × L39 mm), Cable : od.φ4 × L.1450 mm Handle : Thermo Plastic od.φ17 × L.120 mm od.φ3.5 × L.110 mm	Surface, -50°C ~ +300°C / -58°F ~ +572°F, Thin/Flat Disk	
(3) A1.TN332C	4Pin(Pole) Plug(φ38 × L39 mm), Cable : od.φ4 × L.1450 mm Handle : Thermo Plastic od.φ17 × L.120 mm od.φ5.0/3.5 × L.110 mm	Piercing-type Probe : od.φ3.5 mm od.φ5.0 mm With Protective Probe Cap	Robust Piercing, -50°C ~ +300°C / -58°F ~ +572°F, Stronger Penetration Force

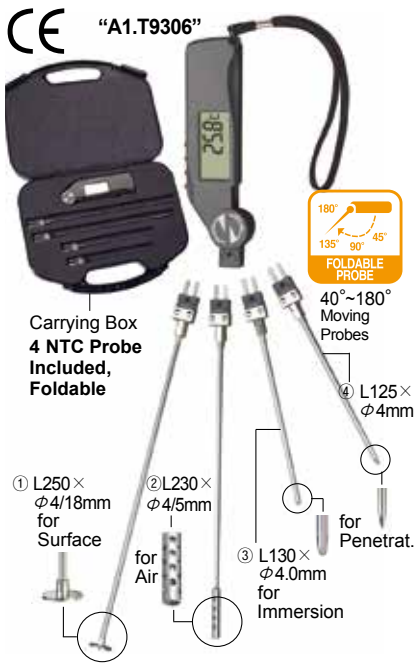

DAIHAN® Foldable / Handy Digital Multi-Thermometer Set
With 4 NTC-Probe & 180° Moving Probe, -50°C ~ +300°C, 휴대용 접이식 온도계

- * Stainless-steel Probe Adjusts From 0° To 180°.
- * CE Approval.
- * Jumbo LCD with Digit Height 18mm.
- * Low Battery Indicator.
- * Black Carrying Case with EVA Foam for Protective and Convenient Carriage.
- * 1 Second Normal Temperature Sensing Time.

Specifications & Ordering information

Spec.	Model	A1.T9306
Measurement Range		-50°C ~ +300°C or -58°F ~ +572°F
Resolution		0.1° for -19.9° ~ +199.9°, Otherwise 1°
Accuracy		±1.0°C or ±1.8°F In the Range of -30°C ~ +250°C or -22°F ~ +482°F, Otherwise more than ±2.0°C or ±4°F
Ambient Temperature for Plastic Case		0°C ~ +50°C or +32°F ~ +122°F
Weight (g) / Color		65 / Grey
Battery/ Package		1 × 1.5Volts "A76" Size (LR44, G13) or Equivalent / Black Carrying Case
Sensor Type		Included 4 Type NTC Thermocouple
Dimension		154 × 41 × 17 mm (LCD Size : 50 × 23mm)
Cat. No. & Price ₩	A1.T9306	Ea

DAIHAN® Module / Handy Solar Digital Thermometer, Max/Min
With 2 of Internal Sensor & 1m External Cable / NTC-Probe, -50°C ~ +300°C, 0.1/1.0°C Divi., 태양광 충전 온도계



Unique Design of Using Solar Energy

- * 1m Wire with Stainless-steel Probe.
- * 1 Second Normal Temperature Sensing Time.
- * Strong Magnet for Easy Attachment.
- * CE Approval.

Specifications & Ordering information

Spec.	Model	A1.T9277B
Measurement Range		-50°C ~ +300°C or -58°F ~ +572°F
Resolution		0.1° for -19.9° ~ +199.9°, Otherwise 1°
Accuracy		±1.0°C or ±1.8°F In the Range of -30°C ~ +250°C or -22°F ~ +482°F, Otherwise more than ±2.0°C or ±4°F
Ambient Temp. / Weight(g) / Color		0°C ~ +50°C or +32°F ~ +122°F / 70g / Green
Battery / Package		1 × 1.5Volts "A76" Size (LR44, G13) or Equivalent / Sliding Blister with Print Card
Sensor Type		External Sharp NTC-Probe : od.φ3.2 × L46mm with 1m Cable
Dimension		103 × 43 × 16 mm (LCD Size : 41 × 15 mm)
Cat. No. & Price ₩	A1.T9277B	Ea

DAIHAN® Handy / Waterproof Multi-Thermometer, with L560mm Cable & NTC-Probe
With 10 Memories Data Storage / Recalling / Clearing, -50°C ~ +300°C, 0.1/1.0°C Divi., 다용도 방수 온도계(온도센서 & 케이블)



- * 4.5mm Diameter of Stainless-steel Probe which Good for Solid Measurement.
- * Alarm Beeps when Temperature Reaches/Beyond the Pre-Set Limit.
- * Flip Out Stand.
- * Compartment for Cable Storage.
- * 1 Second Normal Temperature Sensing Time.
- * Optional One Hour Auto Shut Off.
- * Comprehensive Functions.
- * CE Approval.

Specifications & Ordering information

Spec.	Model	A1.T9235
Measurement Range		-50°C ~ +300°C or -58°F ~ +572°F
Resolution		0.1° for -19.9° ~ +199.9°, Otherwise 1°
Accuracy		±1.0°C or ±1.8°F In the Range of -30°C ~ +250°C or -22°F ~ +482°F, Otherwise more than ±2.0°C or ±4°F
Ambient Temperature		0°C ~ +50°C or +32°F ~ +122°F
Weight (g) / Color / Waterproof		120 / Ivory White, Splashproof
Battery / Package		1 × 1.5Volts "A76" Size (LR44, G13) or Equivalent / Sliding Blister with Print Card
Sensor Type		NTC-Probe : od.φ4.5 × L100mm (with L560mm Cable)
Dimension		118 × 75 × 32 mm (LCD Size : 49 × 22 mm)
Cat. No. & Price ₩	A1.T9235	Ea

Articles

Cat. No

Description

DAIHAN® Pocket / Clip Digital Thermometer, Pen-Shape, L.125mm NTC-Probe Type
 With Protective Plastic Sleeve/Pocket Clip, $-50^{\circ}\text{C} \sim +300^{\circ}\text{C}$, $0.1/1.0^{\circ}\text{C}$ Divi., 포켓형 디지털 온도계(포켓 클립형)

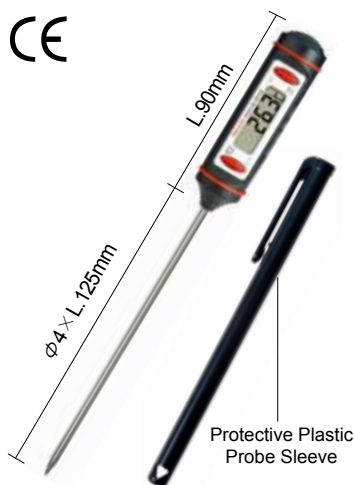

Pocket/Clip Digital Thermometer "A1.T9307"

- * 4mm Diameter of Stainless-steel Probe which Good for Solid Measurement.
- * Instant and Precision Temperature Display.
- * Large LCD Display with Digit Height 10mm.
- * 1 Second Normal Temperature Sensing Time.
- * CE Approval.
- * Pen-Shaped Design

Specifications & Ordering information

Spec.	Model	A1.T9307
Measurement Range		$-50^{\circ}\text{C} \sim +300^{\circ}\text{C}$ or $-58^{\circ}\text{F} \sim +572^{\circ}\text{F}$
Resolution		0.1° for $-19.9^{\circ} \sim +199.9^{\circ}$, Otherwise 1°
Accuracy		$\pm 1.0^{\circ}\text{C}$ or $\pm 1.8^{\circ}\text{F}$ In the Range of $-30^{\circ}\text{C} \sim +250^{\circ}\text{C}$ or $-22^{\circ}\text{F} \sim +482^{\circ}\text{F}$, Otherwise more than $\pm 2.0^{\circ}\text{C}$ or $\pm 4^{\circ}\text{F}$
Ambient Temperature		$0^{\circ}\text{C} \sim +50^{\circ}\text{C}$ or $+32^{\circ}\text{F} \sim +122^{\circ}\text{F}$
Weight (g) / Color		35 / Black
Battery / Package		1 x 1.5 Volts "A76" Size (LR44, G13) or Equivalent / Sliding Blister with Print Card
Sensor Type		NTC-Probe : od. $\phi 4 \times L125\text{mm}$
Dimension		$215 \times 27 \times 27$ mm (LCD Size : 35×11 mm)
Cat. No. & Price ₩	A1.T9307	Ea

DAIHAN® Metal Housing Waterproof (IP67) Thermometer, with Z-Clip & Protective Plastic Sleeve
 Ideal for Kitchen or Lab, Max/Min, with NTC-Probe, $-50^{\circ}\text{C} \sim +150^{\circ}\text{C}$, 포켓형 디지털 방수 온도계(조절 가능 Z클립)



Metal Housing Waterproof(IP67) Thermometer

- * Unique Design of Metal Pulling Housing
- * 2 Points Block Design to Prevent Product Rolling
- * Main Unit Heat Resistance to 80°C
- * Waterproof IP67 Rated
- * Dishwasher Safe
- * You can adjust the spacing of Z-Clip

Specifications & Ordering information

Spec.	Model	A1.ST9341C
Measurement Range		$-50^{\circ}\text{C} \sim +150^{\circ}\text{C}$ or $-58^{\circ}\text{F} \sim +302^{\circ}\text{F}$
Resolution		0.1°
Accuracy		$\pm 1^{\circ}\text{C}$
Ambient Temperature		$0^{\circ}\text{C} \sim +50^{\circ}\text{C}$ or $+32^{\circ}\text{F} \sim +122^{\circ}\text{F}$
Weight (g) / Color		30(g) / Silver
Battery		1 x 1.5 Volts "393" Size or Equivalent
Sensor Type		NTC-Probe : od. $\phi 4 \times L 122\text{mm}$
Dimension		$146 \times 37 \times 37$ mm (LCD Size : 24×12 mm)
Cat. No. & Price ₩	A1.ST9341C	Ea

DAIHAN® Waterproof / Pocket Digital Thermometer, Max/Min, Extension Handle, with NTC-Probe
 With Protective Sleeve/Pocket Clip, $-50^{\circ}\text{C} \sim +300^{\circ}\text{C}$, $0.1/1.0^{\circ}\text{C}$ Divi., 포켓형 디지털 방수 온도계(손잡이 가변형)



size : $206 \times 13 \times 19$ mm

Protective Plastic Probe Sleeve



"A1.T9231C"

Waterproof / Pocket Digital Thermometer

- * Pen-Shaped Design.
- * Ingenious Design of Using Probe Sleeve Vent Hole as a Holder
- * Connecting Probe Sleeve to Head of Unit as a Handle Extension.
- * Press Button Membrane Keypad Function and Display.
- * Waterproof : IP 67.
- * CE Approval.
- * 1 Second Normal Temperature Sensing Time.
- * Convenient Use of Hanger.

Specifications & Ordering information

Spec.	Model	A1.T9231C
Measurement Range		$-50^{\circ}\text{C} \sim +300^{\circ}\text{C}$ or $-58^{\circ}\text{F} \sim +572^{\circ}\text{F}$
Resolution		0.1° for $-19.9^{\circ} \sim +199.9^{\circ}$, Otherwise 1°
Accuracy		$\pm 1.0^{\circ}\text{C}$ or $\pm 1.8^{\circ}\text{F}$ In the Range of $-30^{\circ}\text{C} \sim +250^{\circ}\text{C}$ or $-22^{\circ}\text{F} \sim +482^{\circ}\text{F}$, Otherwise more than $\pm 2.0^{\circ}\text{C}$ or $\pm 4^{\circ}\text{F}$
Ambient Temperature		$0^{\circ}\text{C} \sim +50^{\circ}\text{C}$ or $+32^{\circ}\text{F} \sim +122^{\circ}\text{F}$
Weight (g) / Color		40 / Black
Battery / Package		1 x 1.5 Volts "A76" Size (LR44, G13) or Equivalent / Sliding Blister with Print Card
Sensor Type		NTC-Probe : od. $\phi 4 \times L115\text{mm}$
Waterproof		IP 67
Dimension		$206 \times 13 \times 19$ mm (LCD Size : 25×8 mm)
Cat. No. & Price ₩	A1.T9231C	Ea

DAIHAN® Handy / Waterproof Multi-Thermometer, with Rubber Coated-Housing/-Hanger
 With Detachable $\phi 5 \times L280$ mm Long NTC-Probe, $-50^{\circ}\text{C} \sim +300^{\circ}\text{C}$, $0.1/1.0^{\circ}\text{C}$ Division, **다용도 방수 온도계(분리형 온도센서)**



- * Unique Design of Probe Changeable Unit.
- * 1 Second Normal Temperature Sensing Time.
- * Supplied with Longer and Broader (280mm x $\phi 5$ mm) Probe Together.
- * Waterproof Function : IP 67.
- * Rubber Coated Housing and Hanger.
- * Flexible for Multi Usage.
- * CE Approval.

Specifications & Ordering information

Spec.	Model	A1.T9304C
Measurement Range		$-50^{\circ}\text{C} \sim +300^{\circ}\text{C}$ or $-58^{\circ}\text{F} \sim +572^{\circ}\text{F}$
Resolution		0.1° for $-19.9^{\circ} \sim +199.9^{\circ}$, Otherwise 1°
Accuracy		$\pm 1.0^{\circ}\text{C}$ or $\pm 1.8^{\circ}\text{F}$ In the Range of $-30^{\circ}\text{C} \sim +250^{\circ}\text{C}$ or $-22^{\circ}\text{F} \sim +482^{\circ}\text{F}$, Otherwise more than $\pm 2.0^{\circ}\text{C}$ or $\pm 4^{\circ}\text{F}$
Ambient Temperature		$0^{\circ}\text{C} \sim +50^{\circ}\text{C}$ or $+32^{\circ}\text{F} \sim +122^{\circ}\text{F}$
Weight (g) / Color / Waterproof		275 / Grey · Yellow, IP 67
Battery / Package		1×1.5 Volts "A76" Size (LR44, g13) or Equivalent / White Box
Sensor Type		NTC-Probe : od. $\phi 6 \times L275$ mm(with Connection 325mm)
Dimension		$59 \times 127 \times 22$ mm (LCD Size : 39×35 mm)
Cat. No. & Price ₩	A1.T9304C	Ea

DAIHAN® Waterproof / Handy Multi-Thermometer, with Adjustable Hanger & NTC-Probe, $-50^{\circ}\text{C} \sim +300^{\circ}\text{C}$
 With Jumbo LCD, Max/Min, High- / Low-Alarm, Jumbo LCD, $0.1/1.0^{\circ}\text{C}$ Divi., **포켓형 디지털 방수 온도계(조절 가능 행거)**



- * Designed for Comprehensive of Use.
- * Rubber Coated Adjustable Hanger.
- * Press Button Membrane Keypad Function and Display.
- * Alarm Beeps when Temperature Reaches/ Beyond the Pre-Set Unit.
- * 1 Second Normal Temp. Sensing Time.
- * Jumbo LCD Display with Digit Height 18mm.

Specifications & Ordering information

Spec.	Model	A1.T9314C
Measurement Range		$-50^{\circ}\text{C} \sim +300^{\circ}\text{C}$ or $-58^{\circ}\text{F} \sim +572^{\circ}\text{F}$
Resolution		0.1° for $-19.9^{\circ} \sim +199.9^{\circ}$, Otherwise 1°
Accuracy		$\pm 1.0^{\circ}\text{C}$ or $\pm 1.8^{\circ}\text{F}$ In the Range of $-30^{\circ}\text{C} \sim +250^{\circ}\text{C}$ or $-22^{\circ}\text{F} \sim +482^{\circ}\text{F}$, Otherwise more than $\pm 2.0^{\circ}\text{C}$ or $\pm 4^{\circ}\text{F}$
Ambient Temperature		$0^{\circ}\text{C} \sim +50^{\circ}\text{C}$ or $+32^{\circ}\text{F} \sim +122^{\circ}\text{F}$
Battery / Package / Waterproof		1×1.5 V "A67" Size(LR44, G13) or Equivalent / Sliding Blister with Print Card, IP 67
Sensor Type		NTC-Probe : od. $\phi 4 \times L115$ mm
Dimension & Weight		$210 \times 53 \times 18$ mm (LCD Size : 32×30 mm) , 70g
Cat. No. & Price ₩	A1.T9314C	Ea

DAIHAN® Waterproof/Handy Corkscrew Heavy-Duty Thermometer, for Frozen Food & Solid
 With $\phi 8$ mm Corkscrew NTC-Probe, Protective Sleeve, $-50^{\circ}\text{C} \sim +300^{\circ}\text{C}$, $0.1/1.0^{\circ}\text{C}$ Divi., **나사형 방수 온도계**



- * Rugged Heavy Duty Design.
- * Corkscrew Probe with 8mm Diameter.
- * 1 Second Normal Temperature Sensing Time.
- * CE Approval.
- * Protective Plastic Probe Sleeve with Pocket Clip
- * Waterproof : IP 67.

Specifications & Ordering information

Spec.	Model	A1.T9311C
Measurement Range		$-50^{\circ}\text{C} \sim +300^{\circ}\text{C}$ or $-58^{\circ}\text{F} \sim +572^{\circ}\text{F}$
Resolution		0.1° for $-19.9^{\circ} \sim +199.9^{\circ}$, Otherwise 1°
Accuracy		$\pm 1.0^{\circ}\text{C}$ or $\pm 1.8^{\circ}\text{F}$ In the Range of $-30^{\circ}\text{C} \sim +250^{\circ}\text{C}$ or $-22^{\circ}\text{F} \sim +482^{\circ}\text{F}$, Otherwise more than $\pm 2.0^{\circ}\text{C}$ or $\pm 4^{\circ}\text{F}$
Ambient Temperature		$0^{\circ}\text{C} \sim +50^{\circ}\text{C}$ or $+32^{\circ}\text{F} \sim +122^{\circ}\text{F}$
Weight (g) / Color / Waterproof		75 / Ivory White, IP 67
Battery / Package		1×1.5 Volts "A76" Size (LR44, G13) or Equivalent / Sliding Blister with Print Card
Sensor Type		NTC-Probe : od. $\phi 8 \times L100$ mm
Dimension		$161 \times 100 \times 30$ mm (LCD Size : 35×11 mm)
Cat. No. & Price ₩	A1.T9311C	Ea

Alla® Folding Oven Thermometer, with 1m Stainless Cable & NTC-Probe, Timer/Alarm/Clock, up to 300°C/572°F
 With 1m Stainless Cable & Probe, "Cable-Stay- in Oven", 1° - display, "23Hr-59Min-59Sec" Timer, **접이식 오븐 온도계**



■ **Supplied by Alla® in France**

- * Useable Thermometer Acts as Great Helper in Kitchen.
- * Comprehensive Multi-Functional Device for Temperature and Alarm Checking.
- * With Waterproof Probe (IP 67) and Supplied with 1m Stainless-steel Cable
- * Battery & Protective Plastic Probe Cap Included
- * Maximum Count : 23 : 59 : 59 (Hr : Min : Sec.)
- * Monitoring of Internal Temperature by Probe
- * Magnet at the Back for Easy Attachment
- * In Blister Packaging

Function : On/Off, °C/°F, Timer, Clock, Alarm, High/Low Alarm

Specifications & Ordering information

Spec.	Model	AL.91000.003F
Measurement Range		0 ~ +300°C(1°) / +32 ~ +572°F
Resolution		1°
Accuracy		± 1°C / 1.8°F between 0+150°C / 32+302°F ± 3°C / 5.4°F between 150+300°C / 302+572°F
Battery		2×1.5 Volts "AAA" Size
Dimension (mm)		Folding Screen : 125×70×10mm (LCD Size : 50×35mm) Probe & Cable : 150mm×φ4mm Probe & 100cm Cable
Cat. No. & Price ₩		AL.91000.003F Ea

DAIHAN® Jumbo 2-row display Indoor / Outdoor Digital Thermometer, with NTC-Probe & 3m Cable, Max / Min
 With Flip Out Stand / Hanging Hole / Magnet for Attachment, -50°C~+70°C, 0.1°C Div., **실내/외용 디지털 온도계(2열 표시)**



- * Ideal for Office, Home, Laboratory, etc.
- * Indoor/Outdoor Temperature Display.
- * Flip Out Stand, Hanging Hole and Strong Magnet at the Back for Easy Attachment.
- * 3 Meters Sensor Wire with Probe for Outdoor Temperature Measurement.
- * CE Approval.
- * Dual Row Display for Easy Reading.
- * Pocket Size with Large LCD Display.
- * Magnet at the Back for Easy Attachment.

Specifications & Ordering information

Spec.	Model	A1.T9239	A1.T9267D
LCD Size		LCD Size : 30×40 mm	
Measurement Range		-50°C ~ +70°C or -58°F ~ +158°F	
Resolution		0.1 for Whole Range	
Accuracy		± 1.0°C or ± 1.8°F In the Range of -20°C~+70°C or -4°F ~+158°F Otherwise more than ± 1.0°C or ± 1.8°F	
Ambient Temperature		0°C ~ +50°C or +32°F ~ +122°F	
Weight (g) / Color		70(g) / White	82(g) / White
Battery		1×1.5 Volts "A76" Size (LR44, G13) or Equivalent	
Dimension		70×70×17 mm	67×65×22 mm
Cat. No. & Price ₩		A1.T9239 Ea	A1.T9267D Ea

DAIHAN® LCD Temperature Datalogger, 62000 Sets of Data
 With USB Cable, -20°C~+70°C, **데이터 로거**



- * Instant current temperature read-out
- * Hanging hole and magnet for easy mounting
- * It is connected to the computer via USB cable(Software will be sent by email)
- * Completed with hidden buttons to avoid unexpected operation
- * Works on Windows XP / Vista / 7 or above

Specifications & Ordering information

Spec.	Model	A1.DL104
Measurement Range		-20°C ~ +70°C or -4°F~+158°F or +253°C ~ +343°C
Resolution & Accuracy		0.1°, Accu. ± 1°C
Mode of recording		One-time, Endless Loop (overwriting), End At
Data Capa. and Waterproof		62000 sets of data, and IP×5
Ambient Temp.		-20°C ~ +70°C or -4°F ~ +158°F
Battery		1×3 volts "CR2032" size or equivalent×2
Log interval		1/2/5/10/15/30 seconds 1/2/5/10/15/30/60/90/120 minutes
Dimension		41×60×23 mm (LCD Size : 28×18 mm)
Cat. No. & Price ₩		A1.DL104 Ea

DAIHAN® HACCP Precise Pt-100 Thermometer with Timer, Max / Min / Evg. -100°C ~ +300°C

Ideal for Foodstuff, with IP 67 Waterproof, 99Points Data Record, Alarm & Temp-Programmable, 0.01°C/°F, 정밀 백금 센서 온도계



- * Rigid Housing Design and the Most Accurate Pt100 Probe
- * Complete Set IP67 Waterproof and Washable in Washing Machine
- * Green/Red Dual Color Backlight to Indicate Temp. Hazards
- * Temp. High Alarm Threshold Programmable

- * °C/°F Switchable
- * Max./Min./Avg. Reading Display
- * Hold Function to Freeze Current Reading
- * Countdown Timer Function Included

Spec.	Model	DH.The5
Measure Range		-100 ~ 300°C
Resolution		0.01°C / 0.01°F
Accuracy		±0.15°C
Temp. Response Time		3 mins
RTD Probe Size (mm)		Length - 150mm Diameter - 3.2mm Handle Length - 100mm, Cable Length - 1100mm
Battery		6 × AAA Battery
Dimension / Weight(g)		169 × 78.3 × h34.4 mm (LCD Size : 54 × 32.5 mm) / 200g
Standard Package		Meter / RTD Probe / Stainless Holder / Battery / Manual
Cat. No. & Price ₩	DH.The3005	Set

DAIHAN® Heat Stroke Prevention WBGT Monitor, Temp / RH% / WBGT / Alarm 65dB

Desktop / Wallmount, Programmable Danger Zone, 0~50°C, 20~90% RH, WBGT 0~60°C, WBGT 모니터



W.B.G.T Monitor

- * Wet Bulb Globe Temperature Monitor
- * Checks Dangerous Heat Conditions through WBGT
- * Temperature Unit °C / °F is Switchable
- * Max/Min Function to Review Data
- * Simultaneously Displays Temperature and Humidity
- * Programmable Danger Zone for Warning Purpose
- * Audible Beeper and Bright Red LED for Danger Zone Warning
- * Real Time Display (Hour & Minute, AM/PM)
- * Battery Low indicator

Spec.	Model	DH.The3
3 × Measuring Range		(1) Temp.: 0 ~ 50°C (Display : -10 ~ 70°C), (2) Humidity : 20 ~ 90%RH (Display : 0 ~ 99.9%RH), (3) WBGT : 0 ~ 60°C
2 × Accuracy		(1) Temp.: ±1°C (2) Humidity : ±5%RH (at 25°C, 10 ~ 90%RH, others ±7%RH)
2 × Resolution		(1) Temp.: 0.1°C/0.1°F, (2) Humidity : 0.1%RH
Temp. Response Time		120 Seconds Typical
Battery		3 × AA Battery
Dimension / Weight(g)		110 × 91 × h30mm(LCD Size : 63 × 70 mm) / ~200g
Standard Package		Meter / Battery / Manual / Paper Box
Cat. No. & Price ₩	DH.The3003	Set

DAIHAN® Specialty Thermometer, Digital Spoon Thermometer & Digital Floating Pool Thermometer, 특수 온도계



"A1.T9220Y"

(1) Digital Spoon Thermometer

- CE Approval
- Sensor Type : NTC
- 1 Second Normal Temperature Sensing Time.

(1) Digital Spoon Thermometer, for Baby/Health-Care, -50°C ~ +110°C, 0.1/1.0°C Division

- * Patented
- * Made of ABS Plastic
- * Complies with FDA(US)
- * Ideal for Temp. Measurement of Small amount of Liquid
- * Streamline Design with Spoon Handle

(2) Digital Floating Pool Thermometer, Waterproof IP67, 0°C ~ +50°C, 0.1°C Division

- * Floating On Water
- * Supplied with 3m Nylon Cord with Magnetic Switch to Activate the Unit
- * Ideal for Pool, Water tank, Aquarium
- * Top Scale Reading without Hand Wetting



(2) Digital Floating Pool Thermometer

Spec.	Model	(1) Digital Spoon Thermometer	(2) Digital Floating Pool Thermometer
Measurement Range		-50°C ~ +110°C or -58°F ~ +230°F	0°C ~ +50°C or +32°F ~ +122°F
Resolution		0.1° for -19.9° ~ +199.9°, Otherwise 1°	0.1° for Whole Range
Accuracy		±1.0°C or ±1.8°F In the Range of 30°C ~ +110°C or -22°F ~ +230°F, Otherwise more than ±2.0°C or ±4°F	±1.0°C or ±1.8°F for Whole Range
Ambient Temperature		0°C ~ +50°C or +32°F ~ +122°F	0°C ~ +50°C or +32°F ~ +122°F
Weight (g) / Color		25g / Yellow or Pink, NTC	45g / Light Blue
Battery		1 × 1.5Volts "A76" Size (LR44, G13) or Equivalent	1 × 1.5Volts "AAA" Size or Equivalent
Dimension		175 × 22 × 13mm (LCD Size : 26 × 8 mm)	235 × 142 × 142mm (LCD Size : 71 × 29 mm)
Cat. No. & Price ₩		A1.T9220Y ; Yellow Ea A1.T9220P ; Pink Ea	A1.T9257 Ea

Wisdom Professional Melting Point Analyzer “MP360D”, Up to +300°C ±0.5°C, Two Heating Speeds Simultaneous Measurement of 2 Samples, Internal Cooling Fan, 용점 측정기, 2 샘플 동시측정, 급속 냉각



Professional Melting Point Analyzer

- DAIHAN Designed
- PL(Product Liability) Insurance
- Excellent for the most General Lab Sample Melting Point Applications
- Simultaneous Measurement of Two Samples
- Broader and Clear View with : the Internal LED Light, the Magnified Lens, the Second Internal Display, the Second Internal Display, and the Inclination given by the Hind Legs
- Internal Fan for Rapid Cooling after Measurement
- External Manual Control for Easy and Immediate Hold Function
- Included Capillary Tubes, Close Type, L100mm, 100pcs
- * The Heated Rate is Divided into 2 Speeds to Reduce the Viewing Time :
 - The Fast Stage is Set at 10°C below the Known Melting Point of the Sample.
 - The Temp. is kept at the Fast Stage Point and Beeping for the Next Stage.
- * Ambient Temperature : 5.0 ~ 40°C
- * Hand Held “READ” Push Button to Quick Response
- * Data Recording System : 32 Sets of Data
- * Forced Cooling Reduces Analysis Time.
- * Inside Block Temperature View
- * External Printer(Optional) Automatically Print Sample ID, Date and Melting Point.
- * External Calibration

Specifications & Ordering information

Spec.	Model	“MP360D”
Temp. Range & Accuracy		Ambient to 300°C, ±0.5°C
Temp. Resolution		0.1°C
Fast Stage Ramp Rate		20°C/min Fixed
Slow Ramp Rate		0.2~10°C/min Adjustable, 0.1°C/min Interval
Cooling Rate		25°C/min
Number of Samples		2
Display		4 Digit with 8 Segments
Heating Power Consumption		75W
Dimensions(w×d×h) & Net Weight		160×220×170mm, 1.8kg
Electrical Reqts.		1 Phase, AC 230V, 50 / 60Hz
Cat. No.		DH.Me17011
Price, Each. ₩		



Witeg® Melting Point Capillary Tube, Glass, 용점 측정 모세관

- Supplied by Witeg® in Germany
- * Excellent for Melting Point Determinations. Length 80 mm, Outside diameter 2.5 mm Packed 100 pcs.
- * Use a Powdered Sample * Automatic or Manual Measurement
- * 100 pcs/vial pack

WI.2700000 Melting Point Tube, od 2.5 mm × L80 mm, Both Ends Open
WI.2702000 , One End Closed

Pk.	Price, ₩
100ea	
100ea	

DAIHAN® Programmable Ball Mill, “BML”, 2-/6- Pots, with Certi. & Traceability
 With Digital Feedback Control System, Digital LCD, 50~600 rpm, ± 5 rpm, 10 Steps 6 Programs
 디지털/프로그램식 볼밀/자밀, 2구 & 6구용, 정밀형, 속도조절식



(1) 2-Places Programmable Ball Mill “BML-2”



(2) 6-Places Programmable Ball Mill “BML-6”



Minimum Noise and Safety

Optional Soundproof Cabinet “BMC-6”
 for 6-Places Programmable Ball Mill “BML-6”

- Made in Korea ■ CE Certified ■ PL (Product Liability) Insurance
- with Certificate & Traceability : Controlled by Serial Number, Certificate, Delivery-information, and Traceable Data Base System
- Ideal for Grinding / Mixing : Crystalline Chemicals, Inks, Paints, Pigments, Plants, Racks and Soils
- Microprocessor, Programmable, Variable Speed : 50~600 rpm
- Digital Feedback Control and LCD :
 Speed (RPM), Power Bar-Graph and Timer Status
- * Antistatic Rubber Roller : Keeps Jars / Pots Centered
- * Digital LCD with Back-Light Function
- * Over Load Protection * Ergonomic and Compact Design
- * NBR Roller with Pot Guide Ring
- * Programmable Operation : 10 Steps 6 Programs
- * Storage Function (RPM, Timer)
- * Soundproof Cabinet for Safety and Minimum Noise (Optional)

Specifications & Ordering information

Spec.	Model	(1) “BML-2” Max. 2 Pots	(2) “BML-6” Max. 6 Pots
Capacity		2-places, up to 2 pots	6-places, up to 6 pots
Motor		DC 40W Geared Motor (5 : 1 ratio)	DC 100W Geared Motor (5 : 1 ratio)
Maximum Load		30 kg	60 kg
Speed Range		50 ~ 600 rpm	
Speed Accuracy		± 5 rpm	
Timer		99 hr 59 min (Programmable)	
Display		Digital LCD with Back-Light Function	
Controller		Programmable Digital Feedback Controller with Jog-Shuttle Switch (Turn+Push)	
Program Function		10 Steps, 6 Programs	
Safety Device		Over Load Protector for Motor	
Dimension (w×d×h)	Roller (mm)	50×300	70×800
	External (mm)	620×300×515	1,200×500×795
Packing Size (w×d×h) (mm) & Gross Weight		760×460×700	1,300×620×1,010
		52 kg	115 kg
Power Consumption		40 W	100 W
Electric Reqts.		1 Phase, AC 120 V, 60 Hz or AC 230 V, 50 / 60 Hz	
Cat. No.	230V	DH.WBM05002	DH.WBM05006
	120V	DH.WBM05102	DH.WBM05106
Price, Each. ₩			

* Other Specifications are available upon Customer's Request.

※ 운임 약 ₩ 20,000 별도!

Optional Soundproof Cabinet

* Designed for Minimizing Noise, and Safety Work

- DH.WBM505102 Soundproof Cabinet, “BMC2”, for 2-places“BML-2”,
w1,020×d570×h1,120mm
- DH.WBM505106 Soundproof Cabinet, “BMC6”, for 6-places“BML-6”,
w1,600×d770×h1,400mm

Ea.	Price, ₩

Wisdom Cutting Mill & Pin Mill Common Use "Cml140" & "Pml140", Dry type, Max 4600rpm, Output <0.4~1.3mm
 With Stainless-steel Body, Powerful 1Phase 3HP Motor, Maximum load 5Kg, Input <10mm, **실험실용 커팅밀 & 핀밀 겸용**



Pin Mill, "Pml140"

- Made in Korea
- PL(Product Liability) Insurance
- Low Noise
- with Certificate & Traceability : Controlled by Serial Number, Certificate, Delivery-information, and Traceable Data Base System
- Ideal for Chemicals, Pharmaceuticals, Synthetic Resins, Metals, Ceramics, Mining, etc.

- Extensive Crushing from Granular to Fine Grinding
- Included 0.5mm Screen Sieve for Output Material
- Excellent Quality of Output Material due to Low Heat Generated

- * High Strength and Hardness : SUS304 Body/Feeder/Rotor, SUS430 Screen, SS400 Base Frame
- * The Raw Material is Diffused together with the Airflow by Rotation, and Crushed by the Impact of the Rotating Plate and the Fixed Plate.
- * Adjust the Desired Grinding Particle Size by Replacing the Internal Screen.
- * Pulverizing Various Raw Materials by Replacing the Grinding Disk
- * Easy to Separate and Assemble
- * Easy to Clean and Maintain
- * Simple Interface
- * Include : 4 Screen Sieve, 2 Screen Frame, 2 Filtered collection hopper

Specifications & Ordering information

Spec.	Model	"Cml140" Cutting Mill	"Pml140" Pin Mill
Grinding Disc		Knife type Rotor 8ea × Cutting Knife	Pin type Rotor & Stator 10ea × Rotator Pin, 17ea × Stator Pin
Capacity		5kg(3~10kg/h)	
Hopper Size(w × d × h) / Input Raw Material		120 × 120 × 200 / <10mm	
Screen / Output material Dia.	Include	4ea × 140 / <0.5mm	
	Option	4ea × 60, 80, 100, 180 / <1.3, 0.8, 0.6, 0.4mm	
Speed & Motor	Feeder	25RPM, 40W, DC MOTER	
	Mill & Cutting	4600RPM, 1Phase 3HP	
Body Dia.		φ 165mm	
Dimension & Weight		450 × 550 × h1150, Net. 85kg / Gross. 90kg	
Power Consumption		2.2kW	
Electrical Reqts.		1 Phase, 230V 60Hz	

Cat. No.	DH.Cml7010	DH.Pml7010
Price, Each. ₩		

* Other Specifications are available upon Customer's Request. ※ 운임 약 ₩ 55,000 별도!



(1) Grinding Disk Rotor



(2) Grinding Disk Stator



(3) Grinding Disk Knife

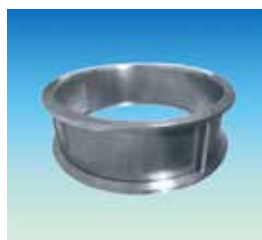

(4) Screen Sieve

Spare Accessory for Standard Chamber

		Ea. Price, ₩
DH.PmlR1011	(1) Grinding Disk Rotor, Stainless-steel, "R1011", for "Pml140"	
DH.PmlS1012	(2) Grinding Disk Stator, Stainless-steel, "S1012", for "Pml140"	
DH.CmlK1011	(3) Grinding Disk Knife, Stainless-steel, "K1011", for "Cml140"	
DH.PmlS1018	(4) Screen Sieve 180, Stainless-steel, Output Material Dia.<φ 0.5mm, "S1018", for "Pml140", "Cml140"	

Optional Accessory

		Ea. Price, ₩
DH.PmlS1015	(4) Screen Sieve 60, Stainless-steel, Output Material Dia.<φ 1.3mm, "S1015", for "Pml140", "Cml140"	
DH.PmlS1016	(4) Screen Sieve 80, Stainless-steel, Output Material Dia.<φ 0.8mm, "S1016", for "Pml140", "Cml140"	
DH.PmlS1017	(4) Screen Sieve 100, Stainless-steel, Output Material Dia.<φ 0.6mm, "S1017", for "Pml140", "Cml140"	
DH.PmlS1019	(4) Screen Sieve 180, Stainless-steel, Output Material Dia.<φ 0.4mm, "S1019", for "Pml140", "Cml140"	

Wisdom Rotated Powder Mill Mixer "Rml300", Dry-type, 300cc, Max 14,000 rpm
 With Automatic Rotating Chamber(15rpm), Stainless-steel Body & SUS440c Blade, PTFE Packing, 회전형 밀 믹서

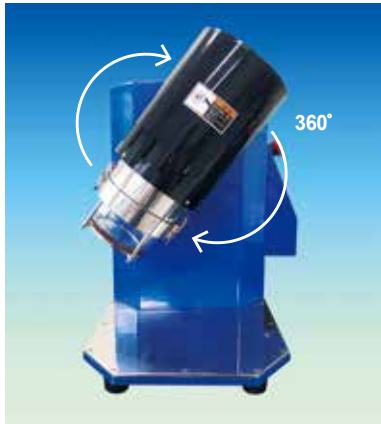

Rotated Powder Mill Mixer "Rml300"

- Made in Korea ■ PL(Product Liability) Insurance
- with Certificate & Traceability : Controlled by Serial Number, Certificate, Delivery-information, and Traceable Data Base System
- Ideal for Laboratory, Pharmaceutical, Chemical, Agriculture, Metal Ribbon, etc.
- Wide Range of Materials Including Rocks, Bone, Ceramic, Glass, Grain, Seed, etc.
- Closed, Dust Tight Crushing & Cutting Sanitary Stainless-steel Chamber(SUS304)
- Included SUS440c Knife Impeller, High strength and hardness Blade
- * Automatic Rotating Chamber (Max.15rpm) Provides Efficient Grinding :
 While the Knife is Rotating(Max.14,000rpm), the Rotation of the Chamber itself Moves the Inner Sample up, down, left, and right to Maximize the Mixing Dispersion.
- * Digital Feedback Control : Steady and Constant Rotating
- * Digital LCD with Back-Light Function
- * Safety Sensor to Check Lid Open
- * Quick and Easy to Clean

Specifications & Ordering information

Spec.	Model	"Rml300"
Capacity / Maximum Load		300cc, $\phi 106 \times h66$ / 1.5kg
Motor		AC High Frequency Motor(300Hz)
Speed Range	Blade	3000~14000rpm
	Chamber	Max.15rpm
Time		Max. 3min (Repeat 99, after 30sec)
Display		4" Digital LCD with Back-Light Function
Controller		PLC-Inverter Controller
Program Function		10 Recipe Memory
Safety Device		Safety Sensor for Lid Open
Dimensions	Body(mm)	w390 \times d520 \times h480
	Chamber(mm)	$\phi 163 \times h72$
Weight		Net. 60kg Gross 65kg
Power Consumption		400W
Electrical Reqts.		AC 230V, 60Hz
Cat. No.		DH.Rml7011
Price, Each. ₩		

※ 운임 약 ₩ 55,000 별도!



(1) Standard Blade $\phi 55$ mm



(2) Standard Blade $\phi 100$ mm



(3) Round Blade $\phi 70$ mm



(4) Propeller Blade $\phi 80$ mm

Spare Accessory Blade

- DH.RmlB1010 (1) Standard Blade, 2-bladed, #440, $\phi 55$ mm, "B1010"
 DH.RmlB1011 (2) , $\phi 100$ mm, "B1011"

Ea.	Price, ₩

Optional Accessory

- DH.RmlB1015 (3) Round Blade, #440, $\phi 70$ mm, "B1015"
 DH.RmlB1016 (4) Propeller Blade, 4-bladed, #304, $\phi 80$ mm, "B1016"

Ea.	Price, ₩

Oven

General Purpose, Forced-air P. 166~167
 , Forced-air, SMART P. 168~169
 , Gravity-air P. 170~171
 , Gravity-air, SMART P. 172~173

High Clean Air P. 174

Industrial/Large-capacity P. 175

Vacuum, General-type P. 176
 , SMART-type P. 177

Vacuum Pump P. 178~179



Forced-air Oven
“ThermoStable™ OF-105”



Gravity-air Oven
“ThermoStable™ SON-105”



Hi-clean Air Oven
“ThermoStable™ WOC-560”



Industrial Oven
“ThermoStable™ WOF-L1000”



Vacuum Oven
“ThermoStable™ SOV-70”



WiRe™ App Service
Controlled by Smart-Phone

DAIHAN® Forced-air Oven “ThermoStable™ OF”, 3-Side Heating Zone, 50 · 105 · 155 · 305 Lit, up to 250°C, ± 0.3°C
 With Wire Shelves/Digital PID Control/Jog-Dial & Push Button/Digital LCD/Back-light LCD/Pre-Heating Zone/Certi. & Traceability
 강제 순환식 정밀 건조기/오븐, 고정밀 디지털 퍼지 제어, 우수한 온도 정확성/균일성



(1) Standard Model, Forced-air Oven

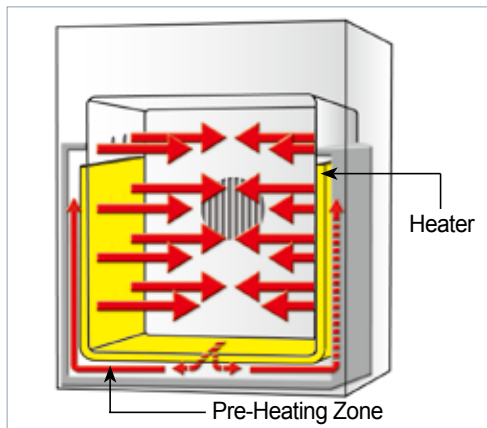

3-Side Heating Zone Forced-air Mechanism :
 The Best Temp. Uniformity & Accuracy by High Performance Heating Mechanism
 (Exclude OF-305, OF-W305)



Perfect Door Lock by Double Latch

- Made in Korea ■ CE / UL / CUL Certified(Exclude 305Lit-model)
- with Certificate & Traceability : Controlled by Serial Number, Certificate, Delivery-information, and Traceable Data Base System
- 3-Side Heating Zone : The Best Temp. Uniformity & Accuracy by High Performance Heating Mechanism
- Digital PID Control System Implementing Superior Temperature Accuracy
- Optimized Air Flow by Forced-air Mechanism ■ GD(Good Design)-mark
- Patented Jog-Dial Control System ■ PL(Prod uct Liability) Insurance
- * Suitable for Drying, Baking, Conditioning, Curing, Pre-Heating and Aging
- * The Best Temp. Uniformity & Accuracy by High Performance Heating Mechanism: 3-Side Heating
- * New Jog-Dial with Push Button ■ Compact New Body Design
- * 2~3ea of Stainless-steel Wire Shelf Included ■ Alarm Function : Error status and Timer-end
- * RS232C Interface for Monitoring and Controlling with PC
- * Ambient +5°C to 250°C Range with Fluctuation of ±0.3°C at 100°C
- * Storage Function of Temperature and Timer setting values
- * Locking Mode Supported for Experimental Safety (Input to Jog-Dial can be disabled)
- * Corrosion Resistant 304 Stainless-steel Chamber
- * Over Temperature & Over Current Protection, Sensor Error Detection

Specification

Spec.	Model	(1) Standard Model			
		ThermoStable OF-50 Max. Capa. 50L	ThermoStable OF-105 Max. Capa. 105L	ThermoStable OF-155 Max. Capa. 155L	ThermoStable OF-305 Max. Capa. 305L
			(2) Standard-Window Model		
		ThermoStable OF-W105	ThermoStable OF-W155	ThermoStable OF-W305	
Capacity	50 Lit	105 Lit	155 Lit	305 Lit	
Dimension (w×d×h)	Interior (mm)	370×345×420	485×415×535	550×480×600	550×470×1,180
	Exterior (mm)	518×647×724	653×712×882	718×777×947	721×777×1,619
Heater Power	650 W	1.4 kW	1.6 kW	3.4 kW	
Temp.	Range	Room Temp +5°C to 250°C			
	Fluctuation	±0.3°C at 100°C, ±0.5°C at 150°C			
	Variation	±1°C at 100°C, ±1.8°C at 150°C		±1°C at 100°C, ±2°C at 150°C	
	Sensor	PT 100			
Control Resolution	±0.1°C				
Heat-up Time	25 min. to 100°C, 45 min. to 150°C	25 min. to 100°C, 40 min. to 150°C			
	Recovery Time (Door open 30sec)	8 min. to 100°C, 8 min. to 150°C	6 min. to 100°C, 6 min. to 150°C		
Controller	Digital PID Control by Advanced Microprocessor Jog-Dial with Push Button				
RS232 Port	Available to connect with PC				
Display	Digital LCD with Back Light				
Timer	99hr 59 min (delay/continuous function)				
Material	Internal	Stainless-steel (#304)			
	External	Powder Coated steel			
	Insulation	Glass Wool			
Shelf (included)	2ea Wire Shelf		3ea Wire Shelf		
	Load per Stainless-steel Wire Shelf : 16 kg				
Ventilation	Ventilation hole with Stainless-steel Cap, Hole Diameter 40mm				
	1ea	2ea	3ea		
	Circulation Forced-air Type				
Safety device	Over Temp. and Over Current Protector, Sensor Error Detector				
Others	UL/CUL Certified, CE Certified, GD-mark, Storage Function (Temp. and Time) Locking Mode (Jog-Dial Input Disabled), Alarm (Error Status and Timer-end)				
Net Weight (kg)	44	69	78	159	
Packing Size (w×d×h)(mm)	622×754×807	743×819×1,068	808×884×1,133	1,000×1,000×1,870	
Shipping Weight (kg)	59	79	92	219	
Power Consumption	674 W	1390 W	1566 W	3200 W	
Energy Consumption, at 100°C , at 150°C	117 Wh	187 Wh	204 Wh	-	
	230 Wh	337 Wh	398 Wh	-	
Electric Reqts.	120V, 60Hz or 230V, 50/60Hz				

* Other Specifications are available upon Customer's Request.

<Continued On Next Page>

Cat. No	Description	Articles
---------	-------------	----------

<Continued From...DAIHAN® Forced-air Oven “ThermoStable™ OF”>

Ordering Information

※ 운임 약 ₩ 25,000 별도!

(1) Standard Model, Forced-air, with Wire Shelf

DH.WOF05050	Oven, Standard, 230V, 50 Lit, “ThermoStable OF-50”
DH.WOF05105	, 105 Lit, “ThermoStable OF-105”
DH.WOF05155	, 155 Lit, “ThermoStable OF-155”
DH.WOF05305	, 305 Lit, “ThermoStable OF-305”
DH.WOF06050	Oven, Standard, 120V, 50 Lit, “ThermoStable OF-50”
DH.WOF06105	, 105 Lit, “ThermoStable OF-105”
DH.WOF06155	, 155 Lit, “ThermoStable OF-155”
DH.WOF06305	, 305 Lit, “ThermoStable OF-305”

Ea. Price, ₩

(2) Built in Viewing Window Model, Forced-air, with Wire Shelf

DH.WOF07105	Oven, Window, 230V, 105 Lit, “ThermoStable OF-W105”
DH.WOF07155	, 155 Lit, “ThermoStable OF-W155”
DH.WOF07305	, 305 Lit, “ThermoStable OF-W305”
DH.WOF08105	Oven, Window, 120V, 105 Lit, “ThermoStable OF-W105”
DH.WOF08155	, 155 Lit, “ThermoStable OF-W155”
DH.WOF08305	, 305 Lit, “ThermoStable OF-W305”

Ea. Price, ₩

Spare Stainless-steel Wire Shelf

DH.WOF11050	Wire Shelf, for 50 Lit, “OFS050”, w340×d310mm
DH.WOF11105	, for 105 Lit, “OFS105”, w455×d375mm
DH.WOF11155	, for 155-/305-Lit, “OFS155”, w520×d440mm

Ea. Price, ₩

Forced-air Oven with Validation (IQ, OQ) Service

DH.WOF31050	Validation Service(IQ, OQ), with “ThermoStable OF-50”, “OFV1050”
DH.WOF31105	Validation Service(IQ, OQ), with “ThermoStable OF-105”, “OFV1105”
DH.WOF31155	Validation Service(IQ, OQ), with “ThermoStable OF-155”, “OFV1155”
DH.WOF31305	Validation Service(IQ, OQ), with “ThermoStable OF-305”, “OFV1305”
DH.WOF32105	Validation Service(IQ, OQ), with “ThermoStable OF-W105”, “OFV2105”
DH.WOF32155	Validation Service(IQ, OQ), with “ThermoStable OF-W155”, “OFV2155”
DH.WOF32305	Validation Service(IQ, OQ), with “ThermoStable OF-W155”, “OFV2305”

Ea. Price, ₩



(2) Standard-Window Model, Forced-air Oven

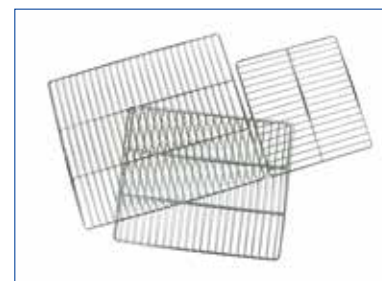

Stainless-steel Wire Shelf (Included)



WiseRemote Control Software :
 Connection of Temperature Devices with Interface RS232C to a PC Export Recorded Data(Excel Spreadsheet)

* You can Download this Software at DAIHAN-Sci.com Shopping-mall

» New Jog-Dial Controller

⑤ Digital LCD with Back-light Function

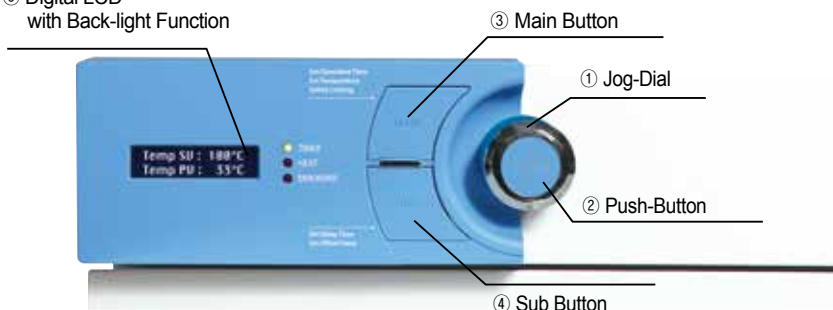

- Provides the user interface with an ergonomic design for users to operate in an easy and convenient way.
- A new 2-way Jog-Dial Knob (Jog Dial + Push Button) and presents excellent durability and mobility.
- High-quality LCD with Back-light function.
- A durable Main Button and a Sub Button that features superb and user-friendly operation.

DAIHAN® SMART Forced-air Oven “ThermoStable™ SOF”, 3-Side Heating Zone, 50 · 105 · 155 · 305 Lit
 With Smart-Lab™ Controller, 4” Full Touch Screen/Fuzzy-PID Control/WiRe™ Service/Certi. & Traceability, up to 250℃, ±0.3℃
 스마트 강제 순환식 정밀 건조기/오븐, 우수한 온도 정확성/균일성, WiRe™서비스, 4인치 풀터치스크린 조절기



(1) Standard Model, “ThermoStable™ SOF-105”

- Made in Korea
 - CE / UL / CUL Certified(Exclude 305 Lit-model)
 - with Certificate & Traceability : Controlled by Serial Number, Certificate, Delivery-information, and Traceable Data Base System
 - 3-Side Heating Zone : The Best Temp. Uniformity & Accuracy by High Performance Heating Mechanism
 - Digital Fuzzy Control System Implementing Superior Temperature Accuracy
 - Smart-Lab™ Controller
 - Optimized Air Flow by Forced-air Mechanism
 - GD(Good Design)-mark
 - PL(Product Liability) Insurance
- * Suitable for Drying, Baking, Conditioning, Curing, Pre-Heating and Aging
 * The Best Temp. Uniformity & Accuracy by High Performance Heating Mechanism : 3 Side-Heating
 * Ergonomic Design 4” Full Touch Screen TFT LCD(Smart-Lab™ Controller)
 * WiRe™ App Service. * Automatic Data Recording
 * Self-Diagnostic Function * Compact New Body Design
 * Variable Program Setting for Multiple Patterns with Multiple Segments
 * Internet Connectivity with WiFi * Controller SW can be upgraded through USB port.
 * The Recorded Data could be transferred to PC by USB memory
 * 2~3ea of Stainless-steel Wire Shelf Included
 * RS232C Interface for Monitoring and Controlling with PC
 * Ambient to 250℃ of Temp. Range, Fluctuation of ±0.3℃ at 100℃
 * Corrosion Resistant 304 Stainless-steel Chamber
 * Over Temperature & Over Current Protection, Sensor Error Detection

Specification

Spec.	Model	(1) SMART Model			
		ThermoStable SOF-50 Max. Capa. 50L	ThermoStable SOF-105 Max. Capa. 105L	ThermoStable SOF-155 Max. Capa. 155L	ThermoStable SOF-305 Max. Capa. 305L
			(2) SMART-Window Model		
		ThermoStable SOF-W105	ThermoStable SOF-W155	ThermoStable SOF-W305	
Capacity	50 Lit	105 Lit	155 Lit	305 Lit	
Dimension (w×d×h)	Interior (mm)	370×345×420	485×415×535	550×480×600	550×470×1,180
	Exterior (mm)	518×647×724	653×712×882	718×777×947	721×777×1,619
Heater Power	650 W	1.4 kW	1.6 kW	3.4 kW	
Temp.	Range	Room Temp +5℃ to 250℃			
	Fluctuation	±0.3℃ at 100℃, ±0.5℃ at 150℃			
	Variation	±1℃ at 100℃, ±1.8℃ at 150℃, ±1℃ at 100℃, ±2℃ at 150℃			
	Sensor	PT 100			
Control Resolution	±0.1℃				
Heat-up Time	25 min. to 100℃, 45 min. to 150℃		25 min. to 100℃, 40 min. to 150℃		
Recovery Time (Door open 30sec)	8 min. to 100℃, 8 min. to 150℃	6 min. to 100℃, 6 min. to 150℃			
Controller	Smart-Lab™ Controller				
RS232 Port	Available to connect with PC				
Display	4” Full Touch Screen TFT LCD				
Timer	99hr 59 min (delay/continuous function)				
Material	Internal	Stainless-steel (#304)			
	External	Powder Coated steel			
	Insulation	Glass Wool			
Shelf (included)	2ea Wire Shelf		3ea Wire Shelf		
	Load per Stainless-steel Wire Shelf : 16 kg				
Ventilation	Ventilation hole with Stainless-steel Cap, Hole Diameter 40mm				
	1ea	2ea	3ea		
	Forced-air Type				
Safety device	Over Temp. and Over Current Protector, Sensor Error Detector				
Others	UL/CUL Certified, CE Certified, GD-mark Storage Function (Temp. and Time), Alarm (Error Status and Timer-end)				
Net Weight (kg)	44	69	78	159	
Packing Size (w×d×h)(mm)	622×754×807	743×819×1,068	808×884×1,133	1,000×1,000×1,870	
Shipping Weight (kg)	59	79	92	219	
Power Consumption	674 W	1390 W	1566 W	3200 W	
Energy Consumption, at 100℃, at 150℃	117 Wh	187 Wh	204 Wh	-	
	230 Wh	337 Wh	398 Wh	-	
Electric Reqts.	120V, 60Hz or 230V, 50/60Hz				

* Other Specifications are available upon Customer's Request.

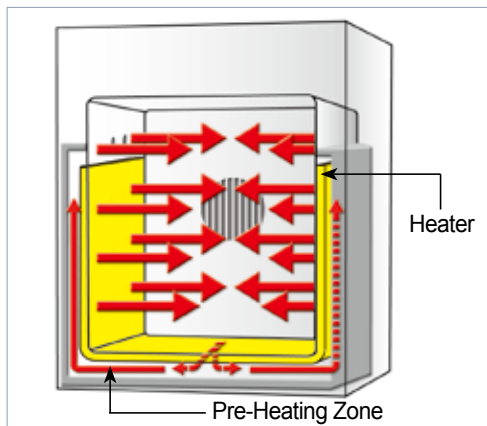

3-Side Heating Zone Forced-air Mechanism :
 The Best Temp. Uniformity & Accuracy by High Performance Heating Mechanism
 (Exclude SOF-305, SOF-W305)



Perfect Door Lock by Double Latch

<Continued On Next Page>

Cat. No	Description	Articles
---------	-------------	----------

<Continued From...DAIHAN® SMART Forced-air Oven "ThermoStable™ SOF">

Ordering Information

※ 운임 약 ₩ 25,000 별도!

(1) Standard Model, Forced-air, with Wire Shelf

		Ea. Price, ₩
DH.SWOF05050	Oven, Standard, 230V, 50 Lit, "ThermoStable SOF-50"	
DH.SWOF05105	, 105 Lit, "ThermoStable SOF-105"	
DH.SWOF05155	, 155 Lit, "ThermoStable SOF-155"	
DH.SWOF05305	, 305 Lit, "ThermoStable SOF-305"	
DH.SWOF06050	Oven, Standard, 120V, 50 Lit, "ThermoStable SOF-50"	
DH.SWOF06105	, 105 Lit, "ThermoStable SOF-105"	
DH.SWOF06155	, 155 Lit, "ThermoStable SOF-155"	
DH.SWOF06305	, 305 Lit, "ThermoStable SOF-305"	

(2) Built in Viewing Window Model, Forced-air, with Wire Shelf

		Ea. Price, ₩
DH.SWOF07105	Oven, Window, 230V, 105 Lit, "ThermoStable SOF-W105"	
DH.SWOF07155	, 155 Lit, "ThermoStable SOF-W155"	
DH.SWOF07305	, 305 Lit, "ThermoStable SOF-W305"	
DH.SWOF08105	Oven, Window, 120V, 105 Lit, "ThermoStable SOF-W105"	
DH.SWOF08155	, 155 Lit, "ThermoStable SOF-W155"	
DH.SWOF08305	, 305 Lit, "ThermoStable SOF-W305"	

Spare Stainless-steel Wire Shelf

		Ea. Price, ₩
DH.WOF11050	Wire Shelf, for 50 Lit, "OFS050", w340×d310mm	
DH.WOF11105	, for 105 Lit, "OFS105", w455×d375mm	
DH.WOF11155	, for 155 / 305 Lit, "OFS155", w520×d440mm	

Forced-air Oven with Validation (IQ, OQ) Service

		Ea. Price, ₩
DH.SWOF31050	Validation Service(IQ, OQ), with "SOF-50", "SOFV1050"	
DH.SWOF31105	, with "SOF-105", "SOFV1105"	
DH.SWOF31155	, with "SOF-155", "SOFV1155"	
DH.SWOF31305	, with "SOF-305", "SOFV1305"	
DH.SWOF32105	Validation Service(IQ, OQ), with "SOF-W105", "SOFV2105"	
DH.SWOF32155	, with "SOF-W155", "SOFV2155"	
DH.SWOF32305	, with "SOF-W305", "SOFV2305"	



(2) SMART-Window Model, Forced-air Oven

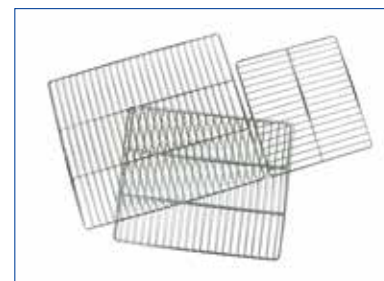

Stainless-steel Wire Shelf (Included)

» DAIHAN WiRe™ App Service



4" Full Touch Screen TFT LCD (Smart-Lab™ Controller)

It is possible to monitor and control the Smart-Lab™ equipment through all smart phone, tablet without restraint of time and place.



WiRe™ App Service

Controlled by Smart-Phone

DAIHAN® Gravity-air Oven “ThermoStable™ ON”, 3-Side Heating Zone, 32 · 50 · 105 · 155 Lit, up to 230°C, ±0.5°C
 With 2 × Wire Shelves/Digital PID Control/Jog-Dial & Push Button, Digital LCD/Back-light, with Certi. & Traceability
 자연 대류식 정밀 건조기/오븐, 고정밀 디지털 퍼지 제어, 우수한 온도 정확성



(1) Standard Model, Gravity-air Oven

- Made in Korea
- UL / CUL Certified
- CE Certified
- with Certificate & Traceability : Controlled by Serial Number, Certificate, Delivery-information, and Traceable Data Base System
- 3-Side Heating Zone : The Best Temp. Uniformity & Accuracy by High Performance Heating Mechanism
- Digital PID Control System Implementing Superior Temperature Accuracy
- Optimized Air Flow by Gravity-air Mechanism
- Patented Jog-Dial Control System
- GD(Good Design)-mark
- PL(Product Liability) Insurance
- * Suitable for Drying, Baking, Conditioning, Curing, Pre-Heating and Aging
- * The Best Temp. Uniformity & Accuracy by High Performance Heating Mechanism : 3-Side Heating
- * New Jog-Dial with Push Button
- * Compact New Body Design
- * 2 ea of Stainless-steel Wire Shelf Included
- * Alarm Function : Error status and Timer-end
- * RS232C Interface for Monitoring and Controlling with PC
- * Ambient +5°C to 230°C Range with Fluctuation of ±0.5°C at 100°C
- * Storage Function of Temperature and Timer setting values
- * Locking Mode Supported for Experimental Safety (Input to Jog-Dial can be disabled)
- * Corrosion Resistant 304 Stainless-steel Chamber
- * Over Temperature & Over Current Protection, Sensor Error Detection

Specification

Spec.	Model	(1) Standard Model			
		ON-32 Max. Capa. 32L	ON-50 Max. Capa. 50L	ON-105 Max. Capa. 105L	ON-155 Max. Capa. 155L
		(2) Standard-Window Model			
Capacity		32 Lit	50 Lit	105 Lit	155 Lit
Dimension (w × d × h)	Interior (mm)	310 × 290 × 360	370 × 350 × 420	485 × 409 × 535	550 × 474 × 600
	Exterior (mm)	458 × 557 × 664	518 × 647 × 724	653 × 712 × 882	718 × 777 × 947
Heater Power		500 W	650 W	1.4 kW	1.6 kW
Temp.	Range	Room Temp +5°C to 230°C			
	Fluctuation	± 0.5°C at 100°C, ± 0.6°C at 150°C			± 0.5°C at 100°C, ± 0.8°C at 150°C
	Variation	± 1.2°C at 100°C, ± 2.2°C at 150°C			
	Sensor	PT 100			
Control Resolution		±0.1°C			
Heat-up Time		30 min. to 100°C, 43 min. to 150°C	30 min. to 100°C, 45 min. to 150°C	35 min. to 100°C, 50 min. to 150°C	
Recovery Time (Door open 30sec)		8 min. to 100°C, 10 min. to 150°C		10 min. to 100°C, 12 min. to 150°C	
Controller		Digital PID Control by Advanced Microprocessor Jog-Dial with Push Button			
RS232 Port		Available to connect with PC			
Display		Digital LCD with Back Light			
Timer		99hr 59 min (delay/continuous function)			
Material	Internal	Stainless-steel (#304)			
	External	Powder Coated steel			
	Insulation	Glass Wool			
Shelf		2ea of Stainless-steel Wire Shelf included, Load per Shelf : 16 kg			
Ventilation		Ventilation hole with Stainless-steel Cap, Hole Diameter 40mm			
		1ea	2ea		
Circulation		Gravity-air Type			
Safety device		Over Temp. and Over Current Protector, Sensor Error Detector			
Others		UL/CUL Certified, CE Certified, GD-mark			
		Storage Function (Temp. and Time)			
		Locking Mode (Jog-Dial Input Disabled)			
		Alarm (Error Status and Timer-end)			
Net Weight (kg)		36	44	69	78
Packing Size (w × d × h) (mm)		562 × 664 × 747	622 × 754 × 807	743 × 819 × 1,068	808 × 884 × 1,133
Shipping Weight (kg)		43	59	79	92
Power Consumption		502 W	674 W	1390 W	1566 W
Energy Consumption, at 100°C , at 150°C		90 Wh	117 Wh	187 Wh	204 Wh
		181 Wh	230 Wh	337 Wh	398 Wh
Electric Reqts.		120V, 60Hz or 230V, 50/60Hz			

* Other Specifications are available upon Customer's Request.

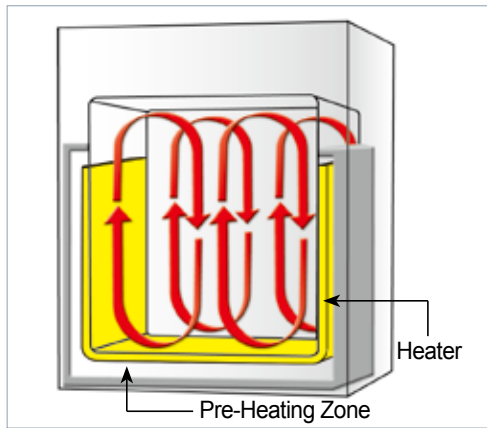

3-Side Heating Zone : The Best Temp. Uniformity & Accuracy by High Performance Heating Mechanism (Gravity-air Mechanism)



Perfect Door Lock by Double Latch

<Continued On Next Page>

Cat. No	Description	Articles
---------	-------------	----------

<Continued From...DAIHAN® Gravity-air Oven "ThermoStable™ ON">

Ordering Information

※ 운임 약 ₩ 25,000 별도!

(1) Standard Model, Gravity-air, with Wire Shelf

		Ea. Price, ₩
DH.WON05032	Oven, Standard, 230V, 32 Lit, "ThermoStable ON-32"	
DH.WON05050	, 50 Lit, "ThermoStable ON-50"	
DH.WON05105	, 105 Lit, "ThermoStable ON-105"	
DH.WON05155	, 155 Lit, "ThermoStable ON-155"	
DH.WON06032	Oven, Standard, 120V, 32 Lit, "ThermoStable ON-32"	
DH.WON06050	, 50 Lit, "ThermoStable ON-50"	
DH.WON06105	, 105 Lit, "ThermoStable ON-105"	
DH.WON06155	, 155 Lit, "ThermoStable ON-155"	

(2) Built in Viewing Window Model, Gravity-air, with Wire Shelf

		Ea. Price, ₩
DH.WON07105	Oven, Window, 230V, 105 Lit, "ThermoStable ON-W105"	
DH.WON07155	, 155 Lit, "ThermoStable ON-W155"	
DH.WON08105	Oven, Window, 120V, 105 Lit, "ThermoStable ON-W105"	
DH.WON08155	, 155 Lit, "ThermoStable ON-W155"	

Spare Stainless-steel Wire Shelf

		Ea. Price, ₩
DH.WON11032	Wire Shelf, for 32 Lit., "ONS032", w280×d280mm	
DH.WON11050	, for 50 Lit., "ONS050", w340×d310mm	
DH.WON11105	, for 105 Lit., "ONS105", w455×d375mm	
DH.WON11155	, for 155 Lit., "ONS155", w520×d440mm	

Gravity-air Oven with Validation (IQ, OQ) Service

		Ea. Price, ₩
DH.WON31032	Validation Service(IQ, OQ), with "ON-32", "ONV1032"	
DH.WON31050	, with "ON-50", "ONV1050"	
DH.WON31105	, with "ON-105", "ONV1105"	
DH.WON31155	, with "ON-155", "ONV1155"	
DH.WON32105	Validation Service(IQ, OQ), with "ON-W105", "ONV2105"	
DH.WON32155	, with "ON-W155", "ONV2155"	



(2) Standard-Window Model, Gravity-air Oven

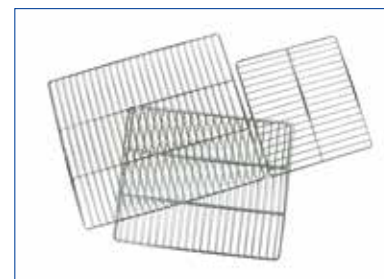

Stainless-steel Wire Shelf (Included)

» New Jog-Dial Controller

⑤ Digital LCD with Back-light Function

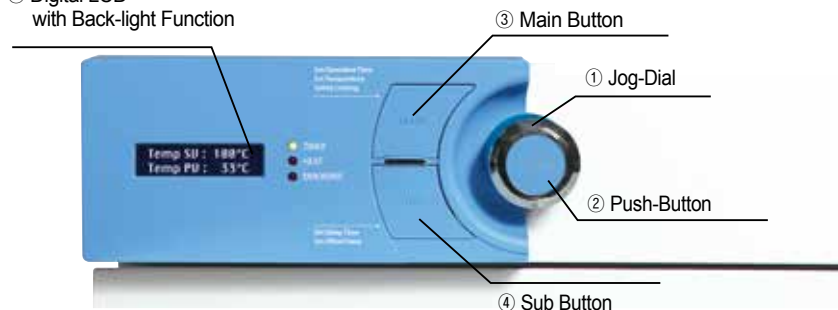

- Provides the user interface with an ergonomic design for users to operate in an easy and convenient way.
- A new 2-way Jog-Dial Knob (Jog Dial + Push Button) and presents excellent durability and mobility.
- High-quality LCD with Back-light function.
- A durable Main Button and a Sub Button that features superb and user-friendly operation.



WiseRemote Control Software :
 Connection of Temperature Devices with Interface RS232C to a PC Export Recorded Data(Excel Spreadsheet)

* You can Download this Software at DAIHAN-Sci.com Shopping-mall

DAIHAN® SMART Gravity-air Oven "ThermoStable™ SON", 3-Side Heating Zone, 32 · 50 · 105 · 155 Lit
 With Smart-Lab™ Controller, 4" Full Touch Screen, Fuzzy-PID Control, WiRe™ Service, with Certi. & Traceability, up to 230°C, ±0.5°C
 스마트 자연 대류식 정밀 건조기/오븐, 우수한 온도 정확성/균일성, WiRe™서비스, 4인치 풀터치스크린 조절기



(1) Standard Model, "ThermoStable™ SON-105"

- Made in Korea
- UL / CUL Certified
- CE Certified
- with Certificate & Traceability : Controlled by Serial Number, Certificate, Delivery-information, and Traceable Data Base System
- 3-Side Heating Zone : The Best Temp. Uniformity & Accuracy by High Performance Heating Mechanism
- Digital Fuzzy Control System Implementing Superior Temperature Accuracy
- Smart-Lab™ Controller
- Optimized Air Flow by Gravity-air Mechanism
- GD(Good Design)-mark
- PL(Product Liability) Insurance
- * Suitable for Drying, Baking, Conditioning, Curing, Pre-Heating and Aging
- * Ergonomic Design 4" Full Touch Screen TFT LCD(Smart-Lab™ Controller)
- * WiRe™ App Service.
- * Automatic Data Recording
- * Self-Diagnostic Function
- * Internet Connectivity with WiFi
- * Variable Program Setting for Multiple Patterns with Multiple Segments
- * The Recorded Data could be transferred to PC by USB memory
- * Controller SW can be upgraded through USB port.
- * Compact New Body Design
- * 2 ea of Stainless-steel Wire Shelf Included
- * RS232C Interface for Monitoring and Controlling with PC
- * Ambient to 230°C of Temp. Range, Fluctuation of ±0.5°C at 100°C
- * Corrosion Resistant 304 Stainless-steel Chamber
- * Over Temperature & Over Current Protection, Sensor Error Detection

Specification

Spec.	Model	(1) SMART Model			
		SON-32 Max. Capa. 32L	SON-50 Max. Capa. 50L	SON-105 Max. Capa. 105L	SON-155 Max. Capa. 155L
				(2) SMART-Window Model	
		SON-W105	SON-W155		
Capacity		32 Lit	50 Lit	105 Lit	155 Lit
Dimension (w×d×h)	Interior (mm)	310×290×360	370×350×420	485×409×535	550×474×600
	Exterior (mm)	458×557×664	518×647×724	653×712×882	718×777×947
Heater Power		500 W	650 W	1.4 kW	1.6 kW
Temp.	Range	Room Temp +5°C to 230°C			
	Fluctuation	± 0.5°C at 100°C, ± 0.6°C at 150°C			± 0.5°C at 100°C, ± 0.8°C at 150°C
	Variation	± 1.2°C at 100°C, ± 2.2°C at 150°C			
	Sensor	PT 100			
Control Resolution		±0.1°C			
Heat-up Time		30 min. to 100°C, 43 min. to 150°C	30 min. to 100°C, 45 min. to 150°C	35 min. to 100°C, 50 min. to 150°C	
	Recovery Time (Door open 30sec)	8 min. to 100°C, 10 min. to 150°C		10 min. to 100°C, 12 min. to 150°C	
Controller		Smart-Lab™ Controller			
RS232 Port		Available to connect with PC			
Display		4" Full Touch Screen TFT LCD			
Timer		99hr 59 min (delay/continuous function)			
Material	Internal	Stainless-steel (#304)			
	External	Powder Coated steel			
	Insulation	Glass Wool			
Shelf		2ea of Stainless-steel Wire Shelf included, Load per Shelf : 16 kg			
Ventilation		Ventilation hole with Stainless-steel Cap, Hole Diameter 40mm			
		1ea		2ea	
Circulation		Gravity-air Type			
Safety device		Over Temp. and Over Current Protector, Sensor Error Detector			
Others		UL/CUL Certified, CE Certified, GD-mark			
		Storage Function (Temp. and Time)			
		Locking Mode (Jog-Dial Input Disabled)			
		Alarm (Error Status and Timer-end)			
Net Weight (kg)		36	44	69	78
Packing Size (w×d×h) (mm)		562×664×747	622×754×807	743×819×1,068	808×884×1,133
Shipping Weight (kg)		43	59	79	92
Power Consumption		502 W	674 W	1390 W	1566 W
Energy Consumption, at 100°C		90 Wh	117 Wh	187 Wh	204 Wh
	, at 150°C	181 Wh	230 Wh	337 Wh	398 Wh
Electric Reqts.		120V, 60Hz or 230V, 50/60Hz			

* Other Specifications are available upon Customer's Request.

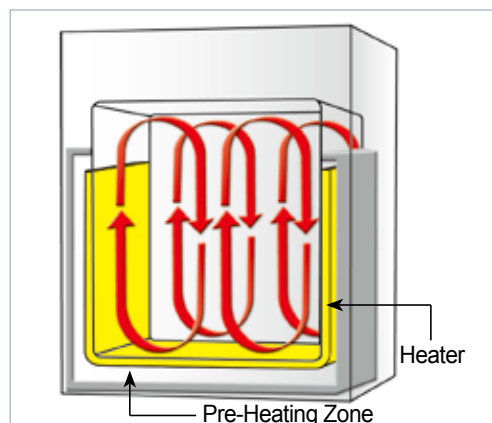

3-Side Heating Zone : The Best Temp. Uniformity & Accuracy by High Performance Heating Mechanism (Gravity-air Mechanism)



Perfect Door Lock by Double Latch

<Continued On Next Page>

Cat. No	Description	Articles
---------	-------------	----------

<Continued From...DAIHAN® SMART Gravity-air Oven "ThermoStable™ SON">

Ordering Information

※ 운임 약 ₩ 25,000 별도!

(1) Standard Model, Gravity-air, with Wire Shelf

DH.SWON05032	Oven, Standard, 230V, 32 Lit, "ThermoStable SON-32"	Ea. Price, ₩
DH.SWON05050	, 50 Lit, "ThermoStable SON-50"	
DH.SWON05105	, 105 Lit, "ThermoStable SON-105"	
DH.SWON05155	, 155 Lit, "ThermoStable SON-155"	
DH.SWON06032	Oven, Standard, 120V, 32 Lit, "ThermoStable SON-32"	
DH.SWON06050	, 50 Lit, "ThermoStable SON-50"	
DH.SWON06105	, 105 Lit, "ThermoStable SON-105"	
DH.SWON06155	, 155 Lit, "ThermoStable SON-155"	

(2) Built in Viewing Window Model, Gravity-air, with Wire Shelf

DH.SWON07105	Oven, Window, 230V, 105 Lit, "ThermoStable SON-W105"	Ea. Price, ₩
DH.SWON07155	, 155 Lit, "ThermoStable SON-W155"	
DH.SWON08105	Oven, Window, 120V, 105 Lit, "ThermoStable SON-W105"	
DH.SWON08155	, 155 Lit, "ThermoStable SON-W155"	

Spare Stainless-steel Wire Shelf

DH.WON11032	Wire Shelf, for 32 Lit, "ONS032", w280×d280mm	Ea. Price, ₩
DH.WON11050	, for 50 Lit, "ONS050", w340×d310mm	
DH.WON11105	, for 105 Lit, "ONS105", w455×d375mm	
DH.WON11155	, for 155 Lit, "ONS155", w520×d440mm	

Gravity-air Oven with Validation (IQ, OQ) Service

DH.SWON31032	Validation Service(IQ, OQ), with "SON-32". "SONV1032"	Ea. Price, ₩
DH.SWON31050	, with "SON-50", "SONV1050"	
DH.SWON31105	, with "SON-105", "SONV1105"	
DH.SWON31155	, with "SON-155", "SONV1155"	
DH.SWON32105	Validation Service(IQ, OQ), with "SON-W105", "SONV2105"	
DH.SWON32155	, with "SON-W155", "SONV2155"	



(2) SMART-Window Model, Gravity-air Oven

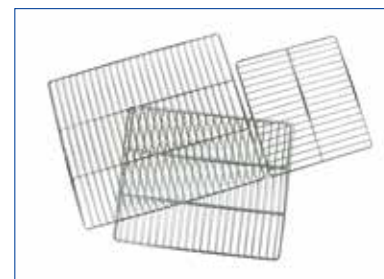

Stainless-steel Wire Shelf (Included)

» DAIHAN WiRe™ App Service



4" Full Touch Screen TFT LCD (Smart-Lab™ Controller)

It is possible to monitor and control the Smart-Lab™ equipment through all smart phone, tablet without restraint of time and place.



WiRe™ App Service

Controlled by Smart-Phone

“ThermoStable™ WOC” High Clean Air Oven, with Class 100 HEPA Filter, 560 · 800 Lit, with Certi. & Traceability
 With Chrome Coated Steel Wire Shelves, Digital Fuzzy Control System, Clean Air Convection Mechanism, up to 250°C, ±1.0°C
 청정 고온 건조기/오븐, 고정밀 디지털 퍼지 제어, 우수한 청정도



High Clean Air Oven, with HEPA Filter
 “ThermoStable™ WOC-560”

- Made in Korea ■ CE Certified ■ PL (Product Liability) Insurance
- with Certificate & Traceability : Controlled by Serial Number, Certificate, Delivery-information, and Traceable Data Base System
- Specially Designed Clean Air Convection Mechanism Provides Dynamic Air Flow for Exhaust of Contaminated Air from the Chamber and Supply of Filtered Clean Air into the Chamber
- Digital Fuzzy Control System Implementing Superior Temperature Accuracy.
- Patented Jog-Shuttle Control System
- * Suitable for Critical Clean Application such as Electronics, Semiconductor, Pharmaceutical and Clinical Applications-Class 100 HEPA Filter is used.
- * Specially Designed Clean Air Convection Mechanism Provides Dynamic Air Flow for Exhaust of Contaminated Air from the Chamber and Supply of Filtered Clean Air into the Chamber
- * Digital Fuzzy Control System Implementing Superior Temperature Accuracy
- * User's Self-Compensation Function to Control Difference between Real Temp. and Indicated Temp. (±20.0°C)
- * Storage Function : Set Values of Temperature and Timer
- * Locking Mode Supported for Experimental Safety(Input to Jog-Shuttle can be Disabled)
- * Over Temperature & Over Current Protection, Sensor Error Detection

Specifications & Ordering information

Spec.	Model	“WOC-560” Max. Capa. 560L	“WOC-800” Max. Capa. 800L
Capacity		560 Lit	800 Lit
Air Flow-type		High Clean Air Convection Mechanism	
Filter for Clean Air		HEPA Filter Class 100 for High Temperature	
Temp.	Range & Sensor	Room Temp. +5°C to 250°C, PT100 Sensor	
	Accuracy & Uniformity	± 1.0°C, ± 2.0°C at 200°C	
Timer & Alarm		99hr 59min (with delay / Continuous run.), Error status & Timer-end	
Display		Digital LCD with Back Light	
Controller		Digital Fuzzy Controller with Jog-Shuttle Switch(Turn+Push)	
Verification		Timer Operated Verification System	
Resolution		Control : ± 1.0°C, Display : ± 1.0°C	
Shelf		3ea of Perforated Shelf of Adjustable Position	
Load per Rack		16 kg, Total : 48 kg (16kg × 3 Shelf)	
Safety Circuit		Over Temp. and Over Current Protector, Sensor Error Detector	
Material		Internal : Stainless-steel (# 304), External : Powder Coated steel, Insulation : Glass Wool	
Others		Storage Function, Locking Mode	
Dimension (w × d × h)	Interior (mm)	800 × 700 × 1,000	1,000 × 800 × 1,000
	Exterior (mm)	1,000 × 1,155 × 1,735	1,500 × 1,200 × 1,900
Packing Size (w × d × h) (mm) & Gross Weight		1,200 × 1,400 × h2,120mm, 386 kg	1,700 × 1,400 × h2,270mm, 446 kg
Power Consumption		6.5 kW	9.4 kW
Electric Reqts.		60Hz or AC 230V, 380V 50/60Hz or 3 Phase	
Cat. No.	230V 3 Phase	DH.WOC00560	DH.WOC00800
	380V 3 Phase	DH.WOC03560	DH.WOC03800
Price, Each. ₩			

* Other Specifications are available upon Customer's Request.

※ 운임 약 ₩ 85,000 별도!



High Efficiency and High Clean Air Convection Mechanism

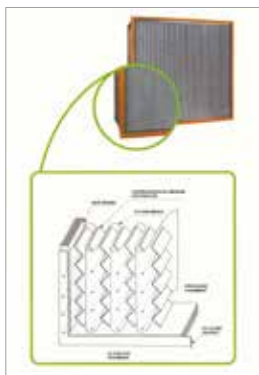

High Temp. HEPA Filter

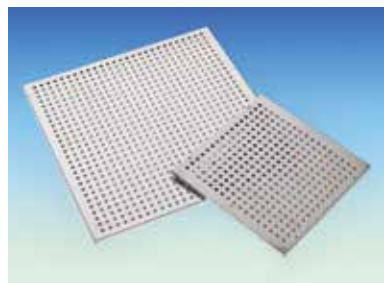

(1) Perforated Shelf, Stainless-steel (Included)

Spare Perforated Shelf, Stainless-steel

	Ea. Price, ₩
DH.WOC10560 (1) Perforated Shelf, “OCS560”, w780 × d680, for “WOC-560”	
DH.WOC10800 “OCS800”, w980 × d880, for “WOC-800”	

Optional N₂ Gas Inlet Device

	Ea. Price, ₩
DH.WOCN2GIN N ₂ Gas Inlet Device, “WOC-N2GIN”	

High Clean Air Oven with Validation (IQ, OQ) Service

	Ea. Price, ₩
DH.WOC30560 Validation Service(IQ, OQ), with “WOC-560”, “OCV560”	
DH.WOC30800 , with “WOC-800”, “OCV800”	

“ThermoStable™ WOF” Industrial Forced-air Oven, 486 · 840 · 1176 Lit, with Certi. & Traceability
 With Stainless-steel Perforated Shelves, Digital PID Control System, Superior Temp. Accuracy, up to 250°C, ±1.0°C
 대용량 산업용 열풍 순환식 건조기 / 오븐, 우수한 온도 정확성



2-Year Warranty

Industrial Forced-air Oven “ThermoStable™ WOF-L1000”
 with Stainless-steel Perforated Shelf

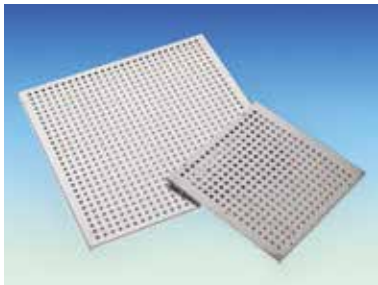

(1) Perforated Shelf, Stainless-steel
 (Included)

- Made in Korea ■ CE Certified ■ PL (Product Liability) Insurance
- with Certificate & Traceability : Controlled by Serial Number, Certificate, Delivery-information, and Traceable Data Base System
- Heavy Forced Air-Circulation by Strong and Reliable Fan System : ideal for Semiconductor and Electronic Parts Baking Purpose
- * Heavy Forced Air-Circulation by Strong and Reliable Fan System : Ideal for Semiconductor and Electronic Parts Baking Purpose
- * Voltage and Ampere Meter Equipped for Monitoring Safe Operation of the Machine
- * Digital PID Control System Enables Superior Temperature Accuracy
- * Digital Timer Function with Buzzer Alarm : up to 99 hrs 59 min
- * Locker is Available for Operational Safety Control by an Administrator
- * Over Temperature & Over Current Protection, Sensor Error Detection and Leakage Breaking
- * Multi-Channel Temperature Sensors with Digital Display for Monitoring Temperature Uniformity in the Chamber is available(Optional)
- * Default Damper to Enhance Thermal Efficiency * Automatic Gas Exhaust Available (Optional)

Specifications & Ordering information

Spec.	Model	“WOF-L400” Max. Capa. 486L	“WOF-L800” Max. Capa. 840L	“WOF-L1000” Max. Capa. 1,176L
Capacity		486 Lit	840 Lit	1,176 Lit
Air Flow-type		Forced-air Type		
Air Circulation Fan Motor		1/3HP	1/3 HP × 2 ea	1/3HP × 3 ea
Temp.	Range	Room Temp. +5 °C to 250 °C		
	Accuracy	± 1.0 °C at 150 °C		
	Uniformity	± 2.0 °C at 150 °C		
	Sensor	PT100		
Heating Power/Consumption		3 kW	5 kW	7 kW
Timer & Alarm		99hr 59min (with Continuous run.), Timer-end Alarm		
Display		2 lines LED for Temperature and Timer		
Controller		Digital PID Control		
Resolution		Control : ± 1.0°C, Display : ± 1.0°C		
Door		Powder coated Steel Door with Silicon Packing		
		1 Door	2 Doors	
Shelf		Included Stainless-steel Perforated Shelf		
		3 ea	3 ea	6 ea
Load per Rack		16 kg		
Permitted Total Load		48 kg (16kg×3 Shelf)		96 kg (16kg×6 Shelf)
Material		Internal : Stainless-steel (# 304), External : Powder Coated steel, Insulation : Ceramic and Glass Wool Board		
Dimension (w×d×h)	Interior (mm)	900×600×900	1,250×700×960	1,400×700×1,200
	Exterior (mm)	1,200×750×1,700	1,500×840×1,800	1,650×840×2,150
Net Weight		316 kg	408 kg	478 kg
Others		Over Temp. and Over Current Protector, Sensor Error Detector, Leakage Breaker Locking Mode by Mechanical Locker		
Packing Size (w×d×h) (mm) & Gross Weight		1,400×1,220×1,960	1,700×1,310×2,060	1,850×1,310×2,410
		376 kg	488 kg	568 kg
Power Consumption		3.6 kW	6.2 kW	8.8 kW
Electric Reqts.		1Phase AC 230V, 50/60Hz	1Phase AC 230V, 50/60Hz	3Phase AC 380V, 50/60Hz
Cat. No.	230V	DH.WOFL0400	DH.WOFL0800	-
	3 Phase	-	DH.WOFL0802	DH.WOFL1002
Price, Each. ₩				

* Other Specifications are available upon Customer's Request.

※ 운임 약 ₩ 85,000 별도!

Spare Perforated Shelf, Stainless-steel

DH.WOF10400 (1) Perforated Shelf, “OFLS400”, w880×d580mm, for “WOF-400”
 DH.WOF10800 , “OFLS800”, w1230×d680mm, for “WOF-800”
 DH.WOF11000 , “OFLS1000”, w660×d680mm, for “WOF-1000”

Ea. Price, ₩

Industrial Forced Convection Oven with Validation (IQ, OQ) Service

DH.WOF30400 Validation Service(IQ, OQ), with “WOF-L400”, “OFLV400”
 DH.WOF30800 , with “WOF-L800”, “OFLV800”
 DH.WOF31000 , with “WOF-L1000”, “OFLV1000”, 3Phase

Ea. Price, ₩

DAIHAN® Gas Exchangeable Precise Vacuum Oven “ThermoStable™ OV”, 20 · 30 · 70 Lit, 10~750 mmHg, 200℃ With Highly Safety View Window, 2 Al-Shelf, Digital PID Control, Superior Temp. & Vacuum Accuracy, with Certi. & Traceability Excellent Thermal Conductivity, 정밀 진공 건조기/오븐, 고정밀 디지털 퍼지 제어, 알루미늄 선반 포함



Precise Vacuum Oven “ThermoStable™ OV-30”



WiseRemote Control Software :

Connection of Temperature Devices with Interface RS232C to a PC Export Recorded Data(Excel Spreadsheet)

* You can Download this Software at DAIHAN-Sci.com Shopping-mall



(1) Standard Shelf, Al.(Included)

- ▶ **Gas Exchangeable, High Heat Conduction and New Jog-Dial Controller & Precise Gauge**
- ▶ **WiseRemote Control Software ; Download at DAIHAN-Sci.com.**
- **Made in Korea** ■ **UL / CUL & CE Certified**
- **with Certificate & Traceability : Controlled by Serial Number, Certificate, Delivery-information, and Traceable Data Base System**
- **Suitable for Drying, Baking, Conditioning, Curing, Out-Gassing Solids and Liquids, Vacuum Embedding, Moisture Testing, Plating and Aging Test**
- **Patented Jog-Dial Control System and Back-Light LCD**
- **PL(Product Liability) Insurance**
- * Very Easy and Convenient for Vacuuming and Venting, Easy to read Vacuum Gauge
- * Highly Safety Viewing Window (Tempered Safety Glass + Polycarbonate Window)
- * Heavy-duty Safety Front Door for User Safety
- * RS232C Interface for Remote Monitoring and Controlling with PC
- * Superior Uniformity and Stability
- * Storage Function : Alarm & Timer
- * High Quality Door Sealing : High Temperature Grade Silicone Molded Gasket
- * Locking Mode Supported for Experimental Safety (Input to Jog-Dial can be disabled)

Specifications & Ordering information

Spec.	Model	ThermoStable™ OV-20 Max. Capa. 20 Lit	ThermoStable™ OV-30 Max. Capa. 30 Lit	ThermoStable™ OV-70 Max. Capa. 70 Lit
Capacity		20 Lit	30 Lit	70 Lit
Vacuum Range & Level & Rate		10 ~ 750 mmHg, 0.63mbar, 0.39mbar/hr		
Temp.	Range / Sensor	R/T +10℃ to 200℃, PT100		
	Accuracy	± 0.5℃ at 100℃ & 150℃		
	Uniformity	± 2.0℃ at 100℃, ± 3.0℃ at 150℃	± 2.5℃ at 100℃, ± 3.5℃ at 150℃	
Heating Power/Consumption		170W×2ea 130W×2ea	350W×2ea 450W×2ea	
Heat-up Time		60 min. to 100℃, 90 min. to 150℃	70 min. to 100℃, 100 min. to 150℃	80 min. to 100℃, 100 min. to 150℃
Timer & Alarm		99hr 59min (with delay / Continuous run.), Error status & Timer-end		
Display		Digital LCD with Back Light		
Controller		Digital PID Controller with Jog-Dial Switch (Turn & Push)		
Resolution		Control : ± 1.0℃, Display : ± 1.0℃		
Shelf (Included)		2 Aluminum Shelf		
Safety Circuit		Over Temp. & Over Current Protector, Sensor Error Detector, Leakage Breaker		
Material		Internal : Stainless-steel (# 304), External : Powder Coated steel, Window : Tempered Safety Glass 12T, Poly Carbonate 5T for Safety		
Others		Storage Function (Temp and Timer), Locking Mode (Jog-Dial Input Disabled)		
Dimension (w×d×h)	Interior (mm)	265×290×265	300×330×300	400×435×400
	Exterior (mm)	480×475×547	515×515×582	618×620×682
Vacuum Inlet Valve Size		od. 10 mm		
Net Weight		48 kg	55 kg	85 kg
Packing Size (w×d×h) (mm) & Gross Weight		570×570×775	605×605×815	710×710×910
		59 kg	67 kg	100 kg
Power Consumption		600 W	600 W	1.6 kW
Electric Rqmts.		1 Phase, AC 120V, 60Hz or AC 230V, 50 / 60Hz		
Cat. No.	230V	DH.WOV03020	DH.WOV03030	DH.WOV03070
	120V	DH.WOV04020	DH.WOV04030	DH.WOV04070
Price, Each. ₩				

* Other Specifications are available upon Customer's Request.

※ **운임 약 ₩ 25,000 별도!**

Spare Aluminum Shelf

DH.WOV12020 (1) Standard Shelf, Alu., “OVSNO20”, 260×245×h3mm, for 20 Lit
 DH.WOV12030 “OVSNO30”, 290×285×h3mm, for 30 Lit
 DH.WOV12070 “OVSNO70”, 390×390×h3mm, for 70 Lit

Ea. Price, ₩

※ **Note! Optional Vacuum Pump : See the “Pump” Section.**

Articles	Cat. No	Description	
----------	---------	-------------	--

DAIHAN® SMART Vacuum Oven “ThermoStable™ SOV”, Highly Safety Viewing Window, 20 · 30 · 70 Lit, 200°C With **Smart-Lab™ Controller**, 4” Full Touch Screen, Fuzzy-PID Control, Superior Temp. & Vacuum Accuracy, 10~750 mmHg
 스마트 진공 건조기/오븐, 고정밀 디지털 퍼지 제어, 알루미늄 선반 포함, with Certi. & Traceability



- **Made in Korea** ■ **UL / CUL & CE Certified** ■ **PL(Product Liability) Insurance**
- **with Certificate & Traceability : Controlled by Serial Number, Certificate, Delivery-information, and Traceable Data Base System**
- **Suitable for Drying, Baking, Conditioning, Curing, Out-Gassing Solids and Liquids, Vacuum Embedding, Moisture Testing, Plating and Aging Test**
- **Smart-Lab™ Controller**
 - WiRe™ App Service. - Automatic Data Recording
 - Self-Diagnostic Function - Internet Connectivity with WiFi
 - Variable Program Setting for Multiple Patterns with Multiple Segments
 - The Recorded Data Could be transferred to PC by USB memory
 - Controller SW can be upgraded through USB port.

- * Very Easy and Convenient for Vacuuming and Venting, Easy to read Vacuum Gauge
- * Highly Safety Viewing Window (Tempered Safety Glass+ Polycarbonate Window)
- * Heavy-duty Safety Front Door for User Safety * Compact New Body Design
- * High Quality Door Sealing : High Temperature Grade Silicone Molded Gasket
- * Over Temperature & Over Current Protection and Sensor Error Detection

Specifications & Ordering information

Spec.	Model	ThermoStable™ SOV-20	ThermoStable™ SOV-30	ThermoStable™ SOV-70
		Max. Capa. 20 Lit	Max. Capa. 30 Lit	Max. Capa. 70 Lit
Capacity		20 Lit	30 Lit	70 Lit
Vacuum Range & Level & Rate		10 ~ 750 mmHg, 0.63mbar, 0.39mbar/hr		
Temp.	Range / Sensor	R/T +10 °C to 200 °C, PT100		
	Accuracy	± 0.5°C at 100°C & 150°C		
	Uniformity	± 2.0°C at 100°C, ± 3.0°C at 150°C	± 2.5°C at 100°C, ± 3.5°C at 150°C	
Heating Power/Consumption		170W×2ea 130W×2ea	350W×2ea 450W×2ea	
Heat-up Time		60 min. to 100 °C, 90 min. to 150 °C	70 min. to 100 °C, 100 min. to 150 °C	80 min. to 100 °C, 100 min. to 150 °C
Timer & Alarm		99hr 59min (with delay / Continuous run.), Error status & Timer-end		
Display		4" Full Touch Screen TFT LCD		
Controller		Smart-Lab™ Controller		
Resolution		Control : ±1.0°C, Display : ±1.0°C		
Shelf		Included 2ea Aluminum Shelf		
Safety Circuit		Over Temp. & Over Current Protector, Sensor Error Detector, Leakage Breaker		
Material		Internal : Stainless-steel (# 304), External : Powder Coated steel, Window : Tempered Safety Glass 12T, Poly Carbonate 5T for Safety		
Others		Program Function, WiRe™ App & Web Service.		
Dimension (w×d×h)	Interior (mm)	265×290×265	300×330×300	400×435×400
	Exterior (mm)	480×475×547	515×515×582	618×620×682
Vacuum Inlet Valve Size		od. 10 mm		
Net Weight		48 kg	55 kg	85 kg
Packing Size (w×d×h) (mm) & Gross Weight		570×570×775	605×605×815	710×710×910
		59 kg	67 kg	100 kg
Power Consumption		600 W	600 W	1.6 kW
Electric Reqts.		1 Phase, AC 120V, 60Hz or AC 230V, 50 / 60Hz		
Cat. No.	230V	DH.SWOV03020	DH.SWOV03030	DH.SWOV03070
	120V	DH.SWOV04020	DH.SWOV04030	DH.SWOV04070
Price, Each. ₩				

* Other Specifications are available upon Customer's Request.

※ **운임 약 ₩ 25,000 별도!**

Spare Aluminum Shelf

DH.WOV12020 (1) Standard Shelf, Alu., “OVSN020”, 260×245×h3mm, for 20 Lit
 DH.WOV12030 “OVSN030”, 290×285×h3mm, for 30 Lit
 DH.WOV12070 “OVSN070”, 390×390×h3mm, for 70 Lit

Ea. Price, ₩



Display of Smart-Lab™ Controller



Pressure Gauge



(1) Standard Shelf, Al.(Included)

※ **Note! Optional Vacuum Pump : See the “Pump” Section.**



(1) VOP-60



(2) VOP-100



(3) VOP-150



(4) VOP-200



(5)

(6)

Vacuumer® Precision Vacuum Pump “VOP-Series”, Gas Ballast Valve Installed, 50~240 Lit With Double-Stage, Direct Drive & Oil Sealed Rotary Type, 정밀 고급형 진공펌프

■ **Made in Korea**

- * Easy-to-use Large Finger Grips
- * Installed Filter Prevent Sludge Contamination
- * Ideal for Vacuum Evaporation Equipment / Vacuum Dryer / Vacuum Freeze Dryer, etc.

■ **Oil Back Flow Prevention Mechanism Installed**

- * Over Current Protection
- * Physical and Chemical Apparatus Industries

Specifications & Ordering information

Model	VOP-60	VOP-100	VOP-150	VOP-200
Pumping Speed (50/60Hz)	50 / 60 Lit/min	100 / 120 Lit/min	150 / 180 Lit/min	200 / 240 Lit/min
Ultimate Pressure (Pa)	6.7 × 10 ⁻² Pa			
Vacuum Degree (mbar)	6.7 × 10 ⁻⁴ mbar			
Motor Power	Single Phase 220V 200W, 4poles	Single Phase 220V 400W, 4poles	Single Phase 220V, 550W, 4poles	
Motor Speed(50/60Hz)	1430 / 1730 RPM			
Recommended Oil	COSMA-100			
Oil Capacity(mL)	800	900	1000	1100
Suction Pipe(o.d × i.d)	NW25(KF25)			
Temp. Range	7~40℃			
Weight	17kg	25kg	28.5kg	30kg
Dimensions(w × d × h)(mm)	165 × 411 × 234	171 × 464 × 238	189 × 504 × 253	189 × 524 × 253
Electric Reqts.	220V, 50 / 60Hz			
Cat. No.	V3.VOP060	V3.VOP100	V3.VOP150	V3.VOP200
Price, Each. ₩				

* Per Customer's request various specifications are available.
 * Using the Macleod gauge the ultimate pressure is measured. The measurements from the pirani gauge are show ln ().

Optional Accessory for VOP-series

Oil Mist Trap

- * Available Less than 200L/min Model, Access Port : NW25(KF25)
- V3.OMT150** (5) Oil Mist Trap for VOP-60 / VOP-100 / VOP-150
- * Available Less than 560L/min Model, Access Port : NW25(KF25)
- V3.OMT300** (6) Oil Mist Trap for All VOP-series

Vacuum Pump Oil

- V3.COS101** (7) Oil for Vacuum Pump VOP-series, 1Lit
- V3.COS104** (8) , 4Lit



(7) & (8)
Oil 1 & 4Lit

Ea.	Price, ₩
Ea.	Price, ₩

DAIHAN® 105mbar Oil Free Vacuum Pump “PU-300”, with Fine Vacuum Regulator and Moisture Trap, 20Lit/min **NEW**
 With Prote™ Overflow Protection, Built-in Thermal Protection, Protection Class IP30, 진공 펌프



105mbar Oil Free Vacuum Pump
“PU-300”

1-Year Warranty

- CE, CSA, and RoHS Certified
- Used for General Filtration, Microbiological Test, Suspended Solid Test, Solid-Phase Extraction, Microplate Vacuum Manifold, Air Sampling, etc.

* Driven by Piston without Lubricant, Regular Oil Change and Maintenance ; No Oil Pollution
 * Prote™ Overflow Protection is Installed to Prevent a Large Amount of Liquid from being Sucked into the Pump.
 * Equipped with Filter Cartridge in Air Inlet to Filter Particle and Moisture to Prolong the Life of Pump.

※ 운임 별도!

Spec.	Model	“PU-300”
Speed of Evacuation		20 Lit/min
Max. Vacuum		105 mbar
Motor Power & Max. Current		60 W, 0.3A
Motor Rotation & Noise Level		1450 rpm, 50 dB
Hose Barb		8 mm
Size & Weight		268 × 135 × h204 mm, 4.1kg
Electric Rqts.		220V, 50Hz
Cat. No.		DH.Pu0300
Price, Each. ₩		

DAIHAN® 15mbar Anticorrosive Vacuum/Pressure Diaphragm Pump “PU-30”, 25psi, 30Lit/min **NEW**
 Ideal for Multi-purpose, Oil-free, Double Heads, 내부식성 진공/압력 다이어프램 펌프, 더블헤드



15mbar Vacuum/Pressure
Diaphragm Pump “PU-30”

1-Year Warranty

- Used for Centrifugal Concentration, Evaporating System, Reduced Pressure Distillation, Solid Phase Extraction, Vacuum Concentration, Vacuum Filtration & Drying System, etc.
- Resistance to Chemicals ; the Parts in Contact with the Gas are PTFE Coated.

* Tolerance to almost all Strong Acid, Alkali, Oxidizer, Reductant and Organic Solvents
 * No Air Pollution due to the Gas Exchange Room with Filtering Material
 * Automatic Cooling Exhaust System ensures Continuous Operation 24hrs a day.
 * Automatic Power off to Protect Motor when the Pump Body Temp Reached at 130 °C.

※ 운임 별도!

Spec.	Model	“PU-30”
Speed of Evacuation		30 Lit/min
Max. Vacuum & Max. Pressure		15 mbar, 25 Psi
Motor Power		160 W
Noise Level & Temp of the body		<60 dB & <55 °C
Pump Head		2
Inlet & Outlet (mm)		id. φ6 & 6 mm, od. φ8 & 8 mm
Diaphragm & Valves		PTFE
Size & Weight		370 × 144 × h275 mm, 13.5kg
Electric Rqts.		220V, 50Hz
Cat. No.		DH.Pu8030
Price, Each. ₩		

DAIHAN® 10mbar Anticorrosive Vacuum Diaphragm Pump “PU-20”, with Fine Regulator and Moisture Trap, 18Lit/min **NEW**
 With Built-in Thermal Protection, Quiet and Low Vibration, 내부식성 저소음/저진동 진공 다이어프램 펌프



10mbar Anticorrosive Vacuum
Diaphragm Pump “PU-20”

1-Year Warranty

- Used for Solvent purification, Gel dryer, Rotary Evaporator, Vacuum Filtration, etc.
- Resistance to Chemicals ; the Parts in Contact with the Gas are PTFE Coated.

* Driven by Diaphragm without Lubricant, Regular Oil Change and Maintenance ; No Oil Pollution
 * Quiet and Low Vibration * Built-in Thermal Protection

※ 운임 별도!

Spec.	Model	“PU-20”
Speed of Evacuation		18 Lit/min
Max. Vacuum		10 mbar
Motor Power & Max. Current		90 W, 0.5A
Motor Rotation & Noise Level		1450 rpm, 52dB
Hose Barb		8mm
Size & Weight		262 × 236 × h193 mm, 7.4kg
Electric Rqts.		220V, 50Hz
Cat. No.		DH.Pu8020
Price, Each. ₩		

Improving the Productivity of Your Chemistry ---

New Innovation LaboRactor™ 0.1 ~ 100Lit

All for Glass Reaction System for Lab & Pilot Plant

AutoLifting- / Classic- / H.Mantle-Models in Vacuum-Line, -80°C +260°C
with Glass Vessel / Lid or PTFE Lid, 45° DN Flange, Safety Connection, and Assembly Frame

Ideal for ▶ Experiment, ▶ Pilot- & Mass-Production



5~100 Lit. AutoLifting-Model I
Manual Tilt, Double-Wall Vessel
High Performance
Ideal for Cleaning



5~100 Lit. Classic-Model II
Double-Wall Vessel
Good for Economic
Operation



0.5~20 Lit. Suspended-Model III
Double-Wall Vessel
Good for Economic
Operation



2~50 Lit. H.Mantle-Model IV
Single-Wall Vessel
Good for Simply
Economic Operation



High-Torque Digital
Overhead Stirrer



PTFE Lids &
Clamping Sys.



Flasks, Round-type



Vessel, Double Wall



PTFE Stirring Impeller

and



General
Multi-Neck Flasks

LaboRactor™ 0.1~100Lit All for Reaction System, for Lab & Pilot Plant, with Glass Vessel, -80°C $+260^{\circ}\text{C}$
 Ideal for Chemistry / Pharmacy / Biomedical / Synthesis in Laboratory & Production Scales in Vacuum Line
 For Reaction, Mixing, Dispersion & Homogenization, 0.5~1.5bar, 연구 및 제품 생산용 진공반응장치

New Innovation AutoLifting & Tilt-System



AutoLifting and Manual Tilting Reactor System "Model-I"

Applications

- Ideal for the Experiment, Pilot Production, and Production in Chemistry / Fine Chemical Engineering / Pharmacy / Synthesis, and Biomedical Engineering.
- Dispersion, Distillation, Evaporation, Homogenization & Mixing Processes at Laboratory & Production-Scales.

Features

- Can be Used Direct Contact Thermo-Probe "K-type"
- Modular System:
You can choose Glass Vessel & Lid or PTFE-Lid, Stirrers, Vacuum Pump & Controller, Heating Mantle, Chiller / Cooler or Heating Circulator.
- Wide-Range Vessels and Convenience:
* 0.1~100Lit Vacuum-Purpose Vessels or General Multi-Neck Flasks.
* Single or Double Walled Glass Vessels.
* With or Without Out-Let Valve at Vessel Bottom.
- "45° DN 60~ DN 200" Standardized Flat-Flange System : with a Comprehensive Range of Accessories and Replacement Parts.
- Convenient O-Ring GROOVE in the Vessel's Flange:
Ideal for Vacuum or Pressure Applications, and Safe Mounting of the Vessel with the Associated Lid.
- All PTFE Safety Lid with Screw Joint or Glass Lid Available : You can choose
- Safety Flexible PTFE Connection for All Joint Parts.
- Fully Digital Feedback / Microprocessor Controlled Agitator(Stirrer) :
LCD Display, Power Bar Graph & Status, Over-Load /-Heat Protection Function.
- With Safety Flexible Coupling between Stirring-Motor & Shaft.
- Easy Installation ; Assembly Frame & Component Parts.
* Good for Heavier-Work.
* Modular Components-Spare or Option Parts.
* Bench- or Floor-Type Assembly Frames.
* Adjustable Height Length and Removable Frame.
* Suppling the Component Parts.

LaboRactor™ 5~100 Lit AutoLifting Vacuum Reactor Set, with Jacketed Glass Vessel · Agitator · Frame · Glass Assembly
With DN O-ring Flange / PTFE-Impeller & -Drainvalve, Digital Agitation & Lifting System, 자동리프팅/자켓 글라스 진공 반응조 세트

▶ **Advantage of Lifting System**

- Safety Cleaning the Vessel
- Easy Feeding of Large Volume Raw Materials
- Ideal for Maintenance

▶ **AutoLifting “Up-Down” and Manual Tilt System**

- With Induction Gear Motor, TM-Screw, Timing Belt & Pulley, and Limit Switch
- * Adjustable Lifting Speed 1~53rpm & Height Length 200~500mm * Tilt Angle 30 Degree

▶ **Graduated Double-wall Vacuum Glass Vessel, 5~100Lit**

- 45° DN Flange & 5mm Thick High Boro-glass 3.3 with Good Physical, Chemical Properties.
- PTFE Lid ; -80℃ ~ +260℃ ■ PTFE Drain Valve ; Aperture ϕ25mm, No-Dead Space
- * Work in Constant Pressure and Vacuum Degree below 0.095MPa in stationary.
- * Cooling and Heating Solution in the Interlayer can be Completely Removed after Reaction.

▶ **High-Torque Digital Agitator System, 50~1000rpm(800rpm/100Lit)**

- CE Certified ■ with Certificate & Traceability : Controlled by Serial Number
- Patented Jog-Shuttle Control System ■ PL(Product Liability) Insurance
- With Safety Flex-Coupling between Stir-Motor and PTFE Shaft, PTFE Impeller.
- * Storage Function for the set values : RPM, Timer, and Locking * Chuck - Corrosion Free.

▶ **Heavier-work Assembly Frame System**

- Material : OD ϕ27.2×thick 1.5/2.0mm Stainless-steel Pipe and AL-Profile 4040
- * Assembly Construction System : Fully Adjustable * Frames according to the Vessel Volumes.
- * with 4 Castors including 2 Lockable Castors. * 80 / 100Lit : OD ϕ27.2×thick 2.0mm STS Pipe



Specification of (A) Reactor Set

Models	“REA-5A”	“REA-10A”	“REA-20A”	“REA-30A”	“REA-50A”	“REA-80A”	“REA-100A”	
Jacket Vessel Volume	5 Lit	10 Lit	20 Lit	30 Lit	50 Lit	80 Lit	100 Lit	
Jacket Volume Approx.	1.2 Lit	2.6 Lit	5 Lit	8 Lit	12 Lit	20 Lit	25 Lit	
Vessel OD × h mm	215 × 370	250 × 480	300 × 630	365 × 710	410 × 800	460 × 970	500 × 970	
Inner Vessel OD mm	185	215	250	330	365	410	460	
Heat Hose Connector	GL25	GL32	GL32	① od 35 × id 18mm Flat Flange & Metal Clamp				
Drain Tube Size	Glass Tube : od 24 × id 19mm			Glass Tube : od 34 × id 20mm				
Digital Stirrer (Agitator)	Model, Control	Direct Controlled “SHT-50DX”			Remote Controlled “SHT-120T”			“SHT-140T”
	Viscosity & Torque	100,000 mPas			150,000 mPas			160,000mPas
	Speed	300 Ncm			500 Ncm			550 Ncm
Lifting	Speed	50~1,000 rpm, Resolution : 1 rpm-Display / 1 rpm-Control						50~800 rpm
	Motor & Rating	Worm-Geared DC Motor (3.5:1 Ratio)						
Lifting	Speed	In · Output 83 / 75 W, 1 / 10 HP			In · Output 130 / 120 W, 1 / 6 HP			
	Height	1~53 rpm, 15 Step Control						
Tilt Angle	200~500mm Distance Control							
Timer & Alarm	Manual 30 Degree							
Display	99hr 59min (with Continuous run.), Error status & Timer-end							
Controller	Digital LCD with Back-Light Function							
Shaft / Impeller	Digital Feedback Controller with Jog Shuttle Switch (Turn + Push)							
Safety Device	ϕ 14mm PTFE Encapsulated Stainless-steel, Exposed End ϕ 12mm, up to 50 Lit.							
Power Consumption	Overload & Heat Protector for Motor							
Dimension Overall	175 W		300 W					
Power Supply	800 × 620 × h1900							
	915 × 670 × h2100		1000 × 720 × h2400		1200 × 790 × h2445			
	1 Phase, AC 230 V, 50 / 60 Hz							

Ordering for (A) Reactor Set, without Circulator & Vacu-Pump

Lifting Reactor Model & Volume	Stirrer Torque and DN-Flange	(1) with Glass Lid, 5 Neck		(2) with PTFE Lid, 6 Neck	
		Cat. No.	Price, ₩	Cat. No.	Price, ₩
“REA-5A”, 5 / 0.1Lit	300Ncm, DN 150	SL.Rea2531		SL.Rea2541	
“REA-10A”, 10 / 0.2Lit	“ ”, “ ”	SL.Rea2532		SL.Rea2542	
“REA-20A”, 20 / 0.4Lit	“ ”, “ ”	SL.Rea2533		SL.Rea2543	
“REA-30A”, 30 / 0.5Lit	“ ”, “ ”	SL.Rea2534		SL.Rea2544	
“REA-50A”, 50 / 1Lit	500Ncm, DN 200	SL.Rea2535		SL.Rea2545	
“REA-80A”, 80 / 1Lit	“ ”, “ ”	SL.Rea2536		SL.Rea2546	
“REA-100A”, 100 / 1Lit	“ ”, “ ”	SL.Rea2537		SL.Rea2547	

※ Note/ DN 150 Flanged PTFE Lid ; 5 Neck for 5Lit Vessel



- (1) Glass Lid With 5 Joints
- (2) All PTFE Lid With 6 Screwjoint
- Top Safety : Non-Breakage, Anti-Chemical, & +280℃

※ Note!

- ▶ (B) & (C) Heat/Cool Circulator and Heat Transfer Fluid : See the “Heating Circulator” Section.
- ▶ (D) Vacuum Pump : See the “Pump” Section.
- ▶ (E) PTFE Thermo-Probe “K-type” : See the “Measuring, Thermometer” Section.

LaboRactor™ 5~100 Lit Classic Vacuum Reactor Set, with Jacketed Glass Vessel · Agitator · Frame · Glass Assembly With DN O-ring Flange / PTFE-Impeller & -Drainvalve, Digital 50~1000rpm, 5~100 Lit 자켓 글라스 진공 반응조 셋트

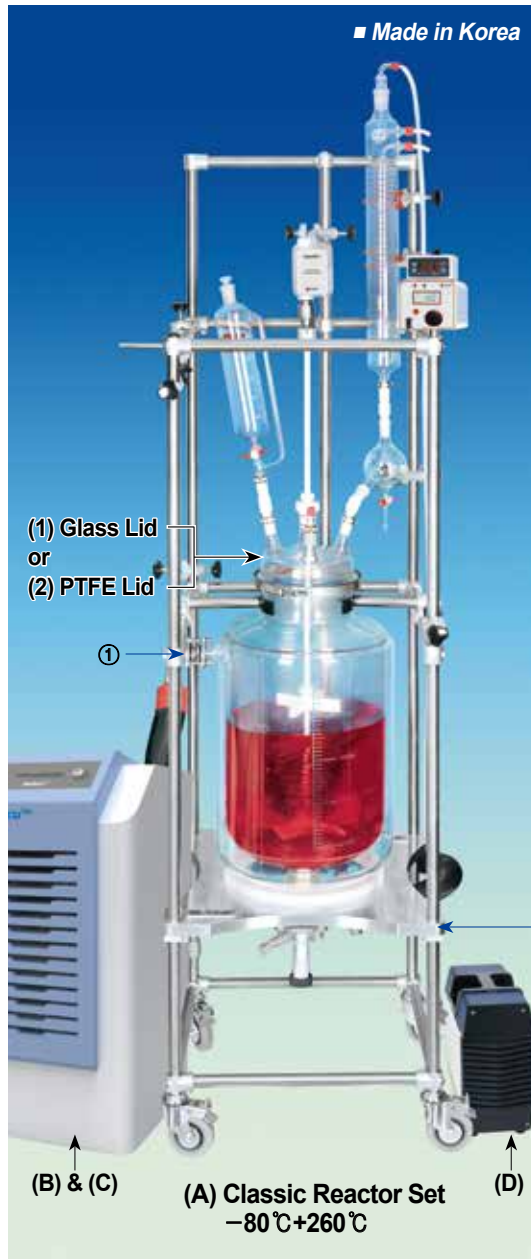

(1) Glass Lid
With 5 Joint



(2) All PTFE Lid
With 6 Screwjoint
○ Top Safety : Non-Breakage,
Anti-Chemical, & +280°C

Heavy-work Support Frame dimension
φ 27.2 × thick 1.5mm STS Pipe

5 & 10 Lit : 45 × 45 × h130cm	50 & 80 Lit : 60 × 60 × h180cm
20 & 30 Lit : 55 × 55 × h170cm	100 Lit : 67 × 67 × h200cm

- ▶ **Graduated Double-wall Vacuum Glass Vessel, 5~100Lit**
- 45° DN Flange & 5mm Thick High Boro-glass 3.3 with Good Physical, Chemical Properties.
- PTFE Lid ; -80°C ~ +260°C ■ PTFE Drain Valve ; Aperture φ25mm, No-Dead Space
- Can be Used Direct Contact Thermo-Probe “K-type”

* Work in Constant Pressure and Vacuum Degree below 0.095MPa in stationary.
* Cooling and Heating Solution in the Interlayer can be Completely Removed after Reaction.

- ▶ **High-Torque Digital Agitator System, 50~1000rpm(800rpm/100Lit)**
- CE Certified ■ with Certificate & Traceability : Controlled by Serial Number
- Patented Jog-Shuttle Control System ■ PL(Product Liability) Insurance
- With Safety Flex-Coupling between Stir-Motor and PTFE Shaft, PTFE Impeller.

* Digital LCD with Back-Light Function. * Smooth Start and Change of the Stirring Speed.
* Storage Function for the set values : RPM and Timer * Chuck - Corrosion Free.
* Locking Mode Supported for Experimental Safety (Input to Jog-Shuttle can be Disabled)

- ▶ **Heavier-work Assembly Frame System ; Fully Adjustable**

■ Material : OD φ27.2 × thick 1.5/2.0mm Stainless-steel Pipe
* with 4 Castors including 2 Lockable Castors. * 80 / 100Lit : OD φ27.2 × thick 2.0mm STS Pipe

Specification of (A) Reactor Set

Models	“REA-5C”	“REA-10C”	“REA-20C”	“REA-30C”	“REA-50C”	“REA-80C”	“REA-100C”	
Jacket Vessel Volume	5 Lit	10 Lit	20 Lit	30 Lit	50 Lit	80 Lit	100 Lit	
Jacket Volume Approx.	1.2 Lit	2.6 Lit	5 Lit	8 Lit	12 Lit	20 Lit	25 Lit	
Vessel OD × h mm	215 × 370	250 × 480	300 × 630	365 × 710	410 × 800	460 × 970	500 × 970	
Inner Vessel OD mm	185	215	250	330	365	410	460	
Heat Hose Connector	GL25	GL32	GL32	① od 35 × id 18mm Flat Flange & Metal Clamp				
Drain Tube Size	Glass Tube : od 24 × id 19mm			Glass Tube : od 34 × id 20mm				
Digital Stirrer (Agitator)	Model, Control	Direct Controlled “SHT-50DX”			Remote Controlled “SHT-120T”			“SHT-140T”
	Viscosity & Torque	100,000 mPas			150,000 mPas		160,000mPas	
		300 Ncm			500 Ncm		550 Ncm	
	Speed	50~1,000 rpm, Resolution : 1 rpm-Display / 1 rpm-Control					50~800 rpm	
	Motor & Rating	Worm-Geared DC Motor (3.5:1 Ratio)						
		In · Output 83 / 75 W, 1 / 10 HP			In · Output 130 / 120 W, 1 / 6 HP			
	Timer & Alarm	99hr 59min (with Continuous run.), Error status & Timer-end						
	Display	Digital LCD with Back-Light Function						
Controller	Digital Feedback Controller with Jog Shuttle Switch (Turn + Push)							
Shaft / Impeller	φ 10/8 PTFE Encapsulated Stainless-steel Shaft			φ 12/10 PTFE Encapsulated Stainless-steel Shaft				
Safety Device	Overload & Heat Protector for Motor							
Power Consumption	85 W					120 W		
Dimension Overall	45 × 45 × h130cm		55 × 55 × h170cm		60 × 60 × h180cm		67 × 67 × h200	
Power Supply	1 Phase, AC 230 V, 50 / 60 Hz							

Ordering for (A) Reactor Set, without Circulator & Vacu-Pump

Classic Reactor Model & Volume	Stirrer Torque and DN-Flange	(1) with Glass Lid, 5 Neck		(2) with PTFE Lid, 6 Neck	
		Cat. No.	Price, ₩	Cat. No.	Price, ₩
“REA-5C”, 5 / 0.1Lit	300Ncm, DN 150	SL.Rea2511		SL.Rea2521	
“REA-10C”, 10 / 0.2Lit	“ ”, DN 200	SL.Rea2512		SL.Rea2522	
“REA-20C”, 20 / 0.4Lit	“ ”, “ ”	SL.Rea2513		SL.Rea2523	
“REA-30C”, 30 / 0.5Lit	“ ”, “ ”	SL.Rea2514		SL.Rea2524	
“REA-50C”, 50 / 1Lit	500Ncm, DN 200	SL.Rea2515		SL.Rea2525	
“REA-80C”, 80 / 1Lit	“ ”, “ ”	SL.Rea2516		SL.Rea2526	
“REA-100C”, 100 / 1Lit	“ ”, “ ”	SL.Rea2517		SL.Rea2527	

※ **Note!** DN 150 Flanged PTFE Lid ; 5 Neck for 5Lit Vessel

※ **Note!**

- ▶ (B) & (C) Heat/Cool Circulator and Heat Transfer Fluid : See the “Heating Circulator” Section.
- ▶ (D) Vacuum Pump : See the “Pump” Section.
- ▶ (E) PTFE Thermo-Probe “K-type” : See the “Measuring, Thermometer” Section.

LaboRactor™ 0.5~20 Lit Suspended Vacuum Reactor Set, with Jacketed Glass Vessel · Agitator · Frame · Glass Assembly With DN O-ring Flange / PTFE-Impeller & -Drainvalve, Digital 50~1000rpm, 행잉 타입 자켓 글라스 진공 반응조 셋트 0.5~20 Lit

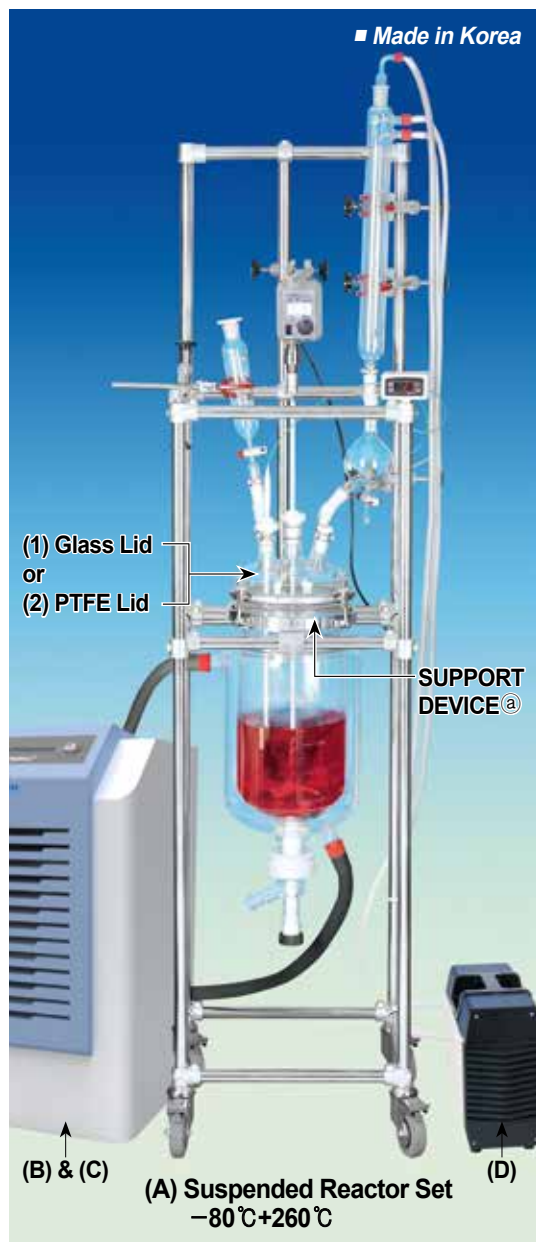

(1) Glass Lid
With 5 Joint



(2) All PTFE Lid
With 6 Screwjoint
◎ Top Safety : Non-Breakage,
Anti-Chemical, & +280 °C



Support Guide® for 10 & 20 Lit



► Easy Installation & Remove, and Safety

► 0.5~20Lit Graduated Double-wall Vacuum Glass Vessel

- 45° DN Flange & 5mm Thick High Boro-glass 3.3 with Good Physical, Chemical Properties.
- PTFE Lid ; -80°C ~ +260°C. ■ PTFE Drain Valve ; No-Dead Space.
- Can be Used Direct Contact Thermo-Probe “K-type”

* Work in Constant Pressure and Vacuum Degree below 0.095MPa in stationary.
* Cooling and Heating Solution in the Interlayer can be Completely Removed after Reaction.

► High-Torque Digital Agitator System, 50~1000rpm

- CE Certified. ■ with Certificate & Traceability : Controlled by Serial Number.
 - Patented Jog-Shuttle Control System. ■ PL(Product Liability) Insurance
 - With Safety Flex-Coupling between Stir-Motor and PTFE Shaft, PTFE Impeller.
- * Digital LCD with Back-Light Function. * Smooth Start and Change of the Stirring Speed.
* Storage Function for the set values : RPM and Timer. * Chuck - Corrosion Free.
* Locking Mode Supported for Experimental Safety (Input to Jog-Shuttle can be Disabled).

► Heavier-work Assembly Frame System ; Fully Adjustable

- Material : OD ϕ 27.2×thick 1.5mm Stainless-steel Pipe.
 - With Heavy-duty Aluminium VESSEL SUSPENSION SUPPORT DEVICE® ; Very Easy Vessel Exchange!
 - With Heavy-duty Stainless-steel SUPPORT Guide® for the Bottom of 10 & 20Lit Vessels.
- * with 4 Castors including 2 Lockable Castors. * Benchtop Frame(With Feet) Available.

Specification of (A) Reactor Set

Models	“REA-S0.5”	“REA-S1”	“REA-S2”	“REA-S3”	“REA-S5”	“REA-S10”	“REA-S20”
Jacket Vessel Volume	0.5Lit	1Lit	2Lit	3Lit	5Lit	10Lit	20Lit
Jacket Volume Approx.	0.2Lit	0.4Lit	0.8Lit	1.1Lit	1.2Lit	2.6Lit	5Lit
Vessel OD×h mm	130×140	130×210	160×250	160×340	215×370	250×480	300×630
Inner Vessel OD mm	105	105	130	130	185	215	250
Heat Hose Connector	GL18		GL25		GL32		
Drain Tube Size	od 15×id 10mm		od 18×id 13mm		od 24×id 19mm		
Digital Stirrer (Agitator)	Model, Control	Direct Controlled “SHT-50DX”					
	Viscosity & Torque	100,000 mPas 300 Ncm					
	Speed	50~1,000 rpm, Resolution : 1 rpm-Display / 1 rpm-Control					
	Motor & Rating	Worm-Geared DC Motor (3.5:1 Ratio) In·Output 83 / 75 W, 1 / 10 HP					
	Timer & Alarm	99hr 59min (with Continuous run.), Error status & Timer-end					
	Display	Digital LCD with Back-Light Function					
	Controller	Digital Feedback Controller with Jog Shuttle Switch (Turn + Push)					
Shaft / Impeller	ϕ 8/6 PTFE Encapsulated Stainless-steel Shaft			ϕ 10/8 PTFE Encapsulated Stainless-steel Shaft			
Safety Device	Overload & Heat Protector for Motor						
Power Consumption	85 W						
Dimension Overall	45×45×h75cm	45×45×h130cm	50×50×h150cm	55×55×h170			
Power Supply	1 Phase, AC 230 V, 50 / 60 Hz						

Ordering for Suspended Reactor Set, without Circulator & Vacu-Pump

Suspen-Reactor Model & Volume	Stirrer Torque and DN-Flange	(1) with Glass Lid, 5-Neck		(2) with PTFE Lid, 5-Neck	
		Cat. No.	Price, ₩	Cat. No.	Price, ₩
“REA-S0.5”, 0.5 / 0.1Lit	300Ncm, DN 100	SL.Rea2481		SL.Rea2491	
“REA-S1”, 1 / 0.1Lit	“ , ”	SL.Rea2482		SL.Rea2492	
“REA-S2”, 2 / 0.2Lit	“ , DN 120	SL.Rea2483		SL.Rea2493	
“REA-S3”, 3 / 0.5Lit	“ , ”	SL.Rea2484		SL.Rea2494	
“REA-S5”, 5 / 0.5Lit	“ , DN 150	SL.Rea2485		SL.Rea2495	
“REA-S10”, 10 / 1Lit	“ , DN 200	SL.Rea2486		SL.Rea2496	
“REA-S20”, 20 / 1Lit	“ , ”	SL.Rea2487		SL.Rea2497	

※ Note/ DN 200 Flanged PTFE Lid ; 6-Neck for 10 & 20 Lit Vessel

※ Note!

- (B) & (C) Heat/Cool Circulator and Heat Transfer Fluid : See the “Heating Circulator” Section.
- (D) Vacuum Pump : See the “Pump” Section.
- (E) PTFE Thermo-Probe “K-type” : See the “Measuring, Thermometer” Section.

Articles Cat. No Description

LaboRactor™ 2~50 Lit Mantle-Heated Reactor Set, with (1) Single-wall Glass Vessel “Kettle” or (2) Round Flask
With DN Series O-ring Flange / PTFE-Impeller & -Drainvalve, Digital 50~1000rpm, 맨틀가열형 진공반응조 세트, 케틀 & 환형



I. M-Model Kettle-type II. MR-Model R.Flask-type

■ Made in Korea

With Mantle Remote Controller

Mantle Heated Reactor Set, with (I) “Kettle” Vessel or (II) Round Flask



(1) Glass Lid With 5 Joint

(2) All PTFE Lid With 6 Screwjoint

© Top Safety : Non-Breakage, Anti-Chemical, & 280 °C



⬆ (E) Option ; PTFE Thermo-Probe “K-type”
⇒ See the “Measuring, Thermometer” Section

▶ DURAN-glass Single-wall Vacuum Glass Vessel

- Ideal for Lab, Pilot- & Mass-Production ■ -80 °C ~ +260 °C Withstand.
 - Can be Used Direct Contact Thermo-Probe “K-type”
 - Single-wall Vacuum Glass Reaction Vessel System with DN Grooved Flange.
 - 5mm Thick High Borosilicate Glass 3.3 with Good Physical, Chemical Properties.
- * Work in Constant Pressure and Vacuum Degree below 0.095MPa in stationary.

▶ Remote-controlled Heating Mantle & Upper Cover, 450 °C

- With Digital Feedback Controller “WGD-30S” : Can be used PTFE External Direct Contact Thermo-Probe “K-type” (E) - Option.
- (B) Fabric-housed Mantle Cover Available - Option ※ Details ⇒ See the Mantle-Section!

▶ High-Torque Digital Agitator System, 50~1000rpm

- CE Certified ■ with Certificate & Traceability : Controlled by Serial Number, Certificate, Delivery-information, and Traceable Data Base System
- Patented Jog-Shuttle Control System ■ PL(Product Liability) Insurance
- With Safety Flex-Coupling between Stir-Motor and PTFE Shaft, PTFE Impeller.

Models	I. Kettle-type	“REA-2M”	“REA-4M”	“REA-6M”	“REA-10M”	“REA-20M”	-
	II. R.Flask-type	“REA-2MR”	“REA-3MR”	“REA-5MR”	“REA-10MR”	“REA-20MR”	“REA-50MR”
Vessel Work Volume	M-Model	2Lit	4/5Lit	6/7Lit	10/12Lit	20/21Lit	-
	MR-Model	2Lit	3Lit	5Lit	10Lit	20Lit	50Lit
Vessel od × h mm	M-Model	130 × 240	200 × 165	215 × 165	240 × 165	250 × 215	-
	MR-Model	165 × 215	185 × 240	225 × 280	280 × 350	350 × 430	480 × 650
Drain Tube Size		od 13 × id 9mm	od 15 × id 10mm			od 18 × id 13mm	
Digital Stirrer (Agitator)	Model, Control	Direct Controlled “SHT-50DX”					Remote Cont. SHT-120T
	Viscosity & Torque	100,000 mPas 300 Ncm					150,000 mPas 500 Ncm
	Speed	50~1,000 rpm, Resolution : 1 rpm-Display / 1 rpm-Control Worm-Geared DC Motor (3.5:1 Ratio)					
	Motor & Rating	In · Output 83 / 75 W, 1 / 10 HP					130/120 W, 1 / 6 HP
	Timer & Alarm	99hr 59min (with Continuous run.), Error status & Timer-end					
	Display	Digital LCD with Back-Light Function					
Controller	Digital Feedback Controller with Jog Shuttle Switch (Turn + Push)						
Heating Mantle	▶ See the Mantle-Section						
Shaft / Impeller	φ 8/6 PTFE Encapsulated Stainless-steel Shaft			φ 10/8 PTFE Encapsulated Stainless-steel Shaft		φ 12/10 PTFE Shaft	
	Safety Device Overload & Heat Protector for Motor						
Power Consumption	635W	885W	935W	1485W	2085W	4120W	
Power Supply	1 Phase, AC 230 V, 50 / 60 Hz						

I. M-model With 2~20Lit Single-Wall Vessel “Kettle-type”, with PTFE Drain Valve

Mantle-heated Reactor Model & Volume	Mantle watts(W) and DN Flange	(1) with Glass Lid, 5 Neck		(2) with PTFE Lid, 5 Neck	
		Cat. No.	Price, ₩	Cat. No.	Price, ₩
“REA-2M”, 2Lit	550W, DN100	SL.Rea2553		SL.Rea2563	
“REA-4M”, 4 / 5Lit	800W, DN150	SL.Rea2554		SL.Rea2564	
“REA-6M”, 6 / 7Lit	“ ”, “ ”	SL.Rea2555		SL.Rea2565	
“REA-10M”, 10 / 12Lit	1400W, “ ”	SL.Rea2556		SL.Rea2566	
“REA-20M”, 20 / 22Lit	2000W, DN200	SL.Rea2557		SL.Rea2567	

* PTFE DN 200 Flanged Lid : 6-neck for 20Lit vessel

II. MR-model With 2~50Lit Round Bottom Flask, with PTFE Drain Valve

Mantle-heated Reactor Model & Volume	Mantle watts(W) and DN Flange	(1) with Glass Lid, 5 Neck		(2) with PTFE Lid, 5 Neck	
		Cat. No.	Price, ₩	Cat. No.	Price, ₩
“REA-2MR”, 2Lit	450W, DN100	SL.Rea2573		SL.Rea2583	
“REA-3MR”, 3Lit	750W, DN120	SL.Rea2574		SL.Rea2584	
“REA-5MR”, 5Lit	850W, “ ”	SL.Rea2575		SL.Rea2585	
“REA-10MR”, 10Lit	1500W, DN150	SL.Rea2576		SL.Rea2586	
“REA-20MR”, 20Lit	2000W, “ ”	SL.Rea2577		SL.Rea2587	
“REA-50MR”, 50Lit	4000W, DN200	SL.Rea2578		SL.Rea2588	

* PTFE DN 200 Flanged Lid : 6-neck for 20Lit vessel

Refrigerator & ULT Freezer

0~10°C Refrigerator, Blood Bank and Pharmaceutical **New** P. 187~188
 , Laboratory / Cold Lab Chamber P. 189

-35°C Bio Freezer P. 190

-86°C ULT Freezer, Personal-type (General & SMART-type) P. 191~192
 , Upright-type (SMART-type) P. 193

-95°C ULT Freezer, Upright-type (SMART-type) P. 194

ULT Freezer Accessory P. 195~196

NEW

Class-II Medical Device

2 ~ +10°C



Blood Bank Refrigerator
"ThermoStable™ BR-300"

Smart-Lab™

-95°C ~ -65°C
Class-II Medical Device

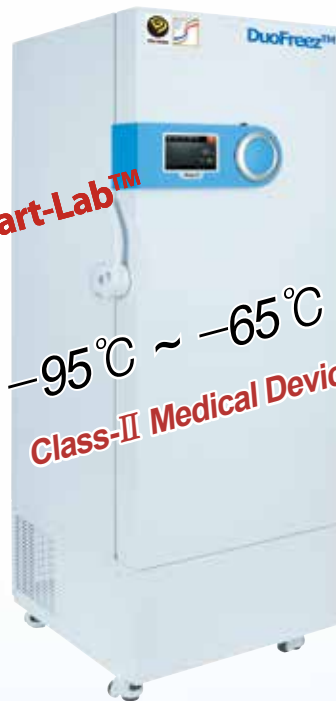

ULT Freezer
"DuoFreez™ U800"

-35°C ~ -10°C



Bio Freezer
"ThermoStable™ WLF-420"

Smart-Lab™

-86°C ~ -65°C
Class-II Medical Device

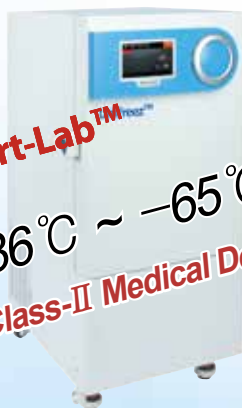

ULT Freezer
"UniFreez™ U80"



WiRe™ App Service

Controlled by Smart-Phone

Articles

Cat. No

Description

DAIHAN® 105 & 295 Lit Blood Bank & Pharmaceutical Refrigerator “BR & PR”, 2~10°C, **Class-I & II Medical Device** **NEW**
 With Microprocessor PID Controller, 60mm(t) Polyurethane Insulation, Vacuum Sealed Glass Door, CFC/HCFC-Free, Forced Air Circulation
 Drawer or Wire Shelf, Superior Temp Uniformity, **혈액보관용 & 시약약품보관용 냉장고**



A. 295Lit Blood Bank Refrigerator “BR-300”



B. 105Lit Pharmaceutical Refrigerator “PR-100”

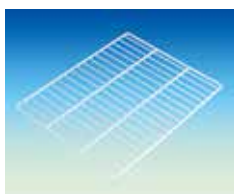
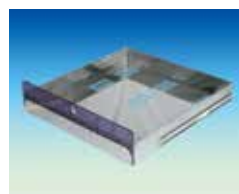

- **Made in Korea**
- **PL(Product Liability)**
- **with Certificate & Traceability : Controlled by Serial Number, Certificate, Delivery-information, and Traceable Data Base System**

- * Energy Saving LED Lamp Installation
- * High Density Polyurethane Insulation(60mm thick) Provides Excellent Low Temperature
- * Invisible Heating Film Protects from water Condensation on the Glass Door
- * Self-Diagnostic and Visual & Audible Alarm System :
 - High/Low Working Room Temp Alarm
 - Electric Power Failure Alarm
 - Status of Door Opening Warning Alarm
 - Low Battery for Controller Warning Alarm
 - Password Locking System for Set Temp

Specifications & Ordering information

Spec.	Model	A. Blood Bank Refrigerator		B. Pharmaceutical Refrigerator	
		“BR-100” 105 Lit, Bench Top	“BR-300” 295 Lit, Floor Standing	“PR-100” 105 Lit, Bench Top	“PR-300” 295 Lit, Floor Standing
Medical Device		NIDS Class-II		NIDS Class-I	
Temp Range		2 ~ 10°C			
Shelf (Included)		1 Basket & 2 Drawer Shelf	3 Drawer Shelf	1 Basket & 2 Wire Shelf	3 Wire Shelf
Compressor		1 / 8 HP	1 / 4 HP	1 / 8 HP	1 / 4 HP
Recorder		Built-in Thermal “STE1005”	Built-in Temp Chart “STE1001”	Option	
Defrost Heater		300 W, Automatic Defrost and Dehumidify System			
Forced Air Circulation		Turbo Fan with Automatic Stop During Door Open			
Controller & Display		Microprocessor Digital Controller / 4 Digit LED Display			
Door		Outer Door with Glass Window with Safety Door Lock System			
Safety		High / Low Temp Alarm, Electric Current Leakage Breaker			
Material		Internal : Stainless-steel, External : Epoxy Powder Coated-steel			
Dimension (w×d×h), (mm)	Interior	465×420×h630	560×660×h800	465×420×h630	560×660×h800
	Exterior	560×640×h900	685×865×h1490	560×640×h900	685×865×h1490
	Packing	720×630×h1050	850×720×h1860	720×630×h1050	850×720×h1860
Net & Gross Weight		65 & 80 kg	170 & 185 kg	65 & 80 kg	170 & 185 kg
Power Consumption		100 W	195 W	100 W	195 W
Electric Reqts.		110V, 60Hz or 220V, 50/60Hz, 1 Phase			
Cat. No.	220V	DH.RefB0100	DH.RefB0300	DH.RefP0100	DH.RefP0300
	110V	DH.RefB0101	DH.RefB0301	DH.RefP0101	DH.RefP0301
Price, Each. ₩					

* Other Specifications are available upon Customer's Request.

※ 운임 별도!

Spare STS Drawer Shelf or Teflon-coated Steel Wire Shelf & Basket

- DH.RefA0001 (1) STS Drawer Shelf, w415×d340 mm, for “BR-100”
- DH.RefA0002 , w520×d560 mm, for “BR-300”
- DH.RefA0005 (2) Teflon-coated Wire Shelf, w440×d350 mm, for “PR-100”
- DH.RefA0006 , w590×d470 mm, for “PR-300”
- DH.RefA0003 (3) Teflon-coated Wire Basket, w440×d340×h175 mm, for “BR-100”, “PR-100”

Ea. Price, ₩

Optional Accessory

- DH.SteA1001 (4) Temp Chart Recorder, “STE1001”, with “STE1002” Chart Paper for “PR-300”
- DH.SteA1002 Chart Paper, “STE1002”, 52 Chart, for 7 day Recording
- DH.SteA1003 Replacement Pen, “STE1003”, 6ea Red Color, for “STE1001”
- DH.SteA1005 (5) Thermal Printer, Paper Roll, “STE1005”
- DH.SteA1006 Thermal Paper Package, 4 Paper Roll, for “STE1005” for “PR”&“BR”
- DH.SteA1010 Mobile Alarm System, “STE1005”

Ea. Price, ₩

Refrigerator with Validation (IQ, OQ) Service

- DH.RefB5100 Validation Service(IQ, OQ), with “BR-100”
- DH.RefB5300 , with “BR-300”
- DH.RefP5100 , with “PR-100”
- DH.RefP5300 , with “PR-300”

Ea. Price, ₩

“ThermoStable™ BR & PR” Blood Bank & Pharmaceutical Refrigerator, 620 & 1140 Lit, **Class-I & II Medical Device(NIDS)**
With PID Controller, Chart Recorder, Door Lock System, Drawer or Wire Shelf, GMP Certi, 0°C ~ 10°C, **혈액보관/시약약품 보관용 냉장고**



(1) 620 Lit Blood Bank Refrigerator “BR-600”



(2) 1140Lit Pharmaceutical Refrigerator “PR-1000”

- Made in Korea ■ CE, GMP Certified ■ PL(Product Liability) Insurance
- with Certificate & Traceability : Controlled by Serial Number, Certificate, Delivery-information, and Traceable Data Base System
- Superior Temperature Uniformity and Quick Recovery by Forced Air Refrigeration System
- CFC-Free Refrigeration System
- Automatic Defrost System

- * Intelligent Control of Refrigerator for Preventing Overload of Compressor
- * Double Fold Tempered Glass Window
- * Alarm Set Points of Temperature Deviation at +5.5 and -1.5 Under Temperature
- * Automatic Condensate Removal, No Drain Line Required
- * Available Built in Chart Recorder and Remote Alarm System(Optional)
- * Built in Battery for Power Failure Alarm

Specifications & Ordering information

Spec.	Model	(1) Blood Bank Refrigerator Drawer-type Shelf		(2) Pharmaceutical Refrigerator Wire Shelf	
		“BR-600” Max. Capa. 620L	“BR-1000” Max. Capa. 1140L	“PR-600” Max. Capa. 620L	“PR-1000” Max. Capa. 1140L
Capacity		620 Lit	1,140Lit	620 Lit	1,140Lit
Medical Device		NIDS Class-II		NIDS Class-I	
Temp. Range		0°C~+10.0°C, at Room Temperature of 30°C and Humidity of 70%			
Temp. Resolution and Sensor		1°C-Display, 1°C-Control, PT100 Sensor			
Refrigerant		CFC-Free(R-134A) Refrigeration System			
Compressor		1/3 HP			
Evaporator		Auto Exchange Dual Evaporator			
Air Circulation		Dual Turbo Fan Forced-air Type			
Defrost		Automatic Defrost System			
Controller & Display		Digital PIDcontroller, LCD Display			
Door		Outer Door with Glass Window with Safety Door Lock System			
Shelf (Included)		6 Drawer Shelf	12 Drawer Shelf	5 Wire Shelf	10 Wire Shelf
Recorder		Included Chart Recorder			
Others		with Door Lock Device, Over Current- & Temp. Protection, Sensor Error Detection			
Material		Internal : Stainless-steel, External : Powder Coated-steel			
Dimension (w×d×h)	Internal(mm)	620×700×1,430	1,140×700×1,430	620×700×1,430	1,140×700×1,430
	External(mm)	740×805×1,930	1,260×805×1,930	740×805×1,930	1,260×805×1,930
Net Weight		134 kg	208 kg	134 kg	208 kg
Power Consumption		650 W	750 W	650 W	750 W
Electrical Reqts.		1 Phase, AC120V, 60Hz or AC230V, 50/60Hz			
Cat. No.	230V	DH.RefB0600	DH.RefB1000	DH.RefP0600	DH.RefP1000
	120V	DH.RefB0601	DH.RefB1001	DH.RefP0601	DH.RefP1001
Price, Each. ₩					

* Other Specifications are available upon Customer's Request.

※ 운임 약 ₩ 95,000 별도!

Spare Perforated Drawer Shelf or Teflon-coated Steel Wire Shelf



(a) Included Perforated
Drawer Shelf



(b) Teflon-coated Steel
Wire Shelf

- DH.RefA0007 (a) Perforated Drawer Shelf, Stainless-steel,
w570×d570 mm, for “BR-600”
- DH.RefA0008 (a) Perforated Drawer Shelf, Stainless-steel,
w470×d570 mm, for “BR-1000”
- DH.RefA0003 (b) Wire Shelf, Teflon-coated Steel,
w600×d624 mm, for “PR-600”
- DH.RefA0004 (b) Wire Shelf, Teflon-coated Steel,
w560×d624 mm, for “PR-1000”

Ea. Price, ₩

“ThermoStable™ LR” Smart Laboratory Refrigerator, Automatic Defrost System, 0℃~10℃, 620- & 1140-Lit With Smart-Lab™ System, Teflon-coated Steel Wire Shelf, CFC-Free, Door Lock Device, 실험실용 다용도 냉장고



(1) 620 Lit Laboratory Refrigerator “LR-600”



(2) 1140Lit Laboratory Refrigerator “LR-1000”

- Made in Korea ■ CE Certified ■ PL(Product Liability) Insurance
- with Certificate & Traceability : Controlled by Serial Number, Certificate, Delivery-information, and Traceable Data Base System
- Superior Temperature Uniformity and Quick Recovery by Forced Air Refrigeration System
- CFC-Free Refrigeration System ■ Automatic Defrost System
- **Smart-Lab™ Controller**
 - Ergonomic 7" Full Touch Screen TFT LCD(Smart-Lab™ Controller)
 - WiRe™ App Service.
 - Internet Connectivity with WiFi
 - Self-Diagnostic Function
 - Automatic Data Recording
 - Push Alarm Service to Smart Phone : Power- / Temperature- / Door Open-Error Status
 - Built in USB port for Data Download and Program Upgrade
 - Password Protected Setting
 - Interactive Temperature Graph
 - Digital Calibration(Offset Function)
 - Min-/Max-Temperature
- * Intelligent Control of Refrigerator for Preventing Overload of Compressor
- * Double Fold Tempered Glass Window * Built in Battery for Power Failure Alarm
- * Alarm Set Points of Temperature Deviation at +5.5 and -1.5 Under Temperature
- * Automatic Condensate Removal, No Drain Line Required
- * Available Built in Chart Recorder and Remote Alarm System(Optional)

Specifications & Ordering information

Spec.	Model	SMART Laboratory Refrigerator Teflon-coated Steel Wire Shelf	
		“LR-600” Max. Capa. 620 Lit	“LR-1000” Max. Capa. 1140 Lit
Capacity & Doors		620 Lit, 1-Door	1,140Lit, 2-Doors
Temp. Range		0℃~+10.0℃ (PT100 Sensor)at R/T of 30℃ and Humidity of 70%	
Temp. Resolution		1℃-Display, 1℃-Control	
Refrigerant		CFC-Free(R-134A) Refrigeration System	
Compressor & Evaporator		1/3 HP, Auto Exchange Dual Evaporator	
Air Circulation		Dual Turbo Fan Forced-air Type	
Defrost & Circulation		Automatic Defrost System, Dual Turbo Fan	
Controller & Display		Smart-Lab Controller, 7" Full Touch Screen TFT LCD, WiRe™ App Service	
Door		Outer Door with Glass Window	
Shelf (Included)		5 Teflon-coated Steel Wire Shelf	10 Teflon-coated Steel Wire Shelf
Others		with Door Lock Device, Over Current- & Temp, Over Current Protection, Sensor Error Detection	
Material		Internal : Stainless-steel, External : Powder Coated-steel	
Dimension (w×d×h)	Internal(mm)	620×700×1,430	1,140×700×1,430
	External(mm)	740×805×1,930	1,260×805×1,930
Net Weight		134 kg	208 kg
Power Consumption		650 W	750 W
Electrical Reqts.		1 Phase, AC120V, 60Hz or AC230V, 50/60Hz	
Cat. No.	230V	DH.Refl0600	DH.Refl1000
	120V	DH.Refl0601	DH.Refl1001
Price, Each. ₩			

* Other Specifications are available upon Customer's Request.

※ 운임 약 ₩ 95,000 별도!

Spare Teflon-coated Steel Wire Shelf

- DH.ReflA0003 (a) Wire Shelf, Teflon-coated Steel, w600×d624 mm, for “LR-600”
- DH.ReflA0004 (a) , w560×d624 mm, for “LR-1000”

Ea. Price, ₩

WiRe™ App Service

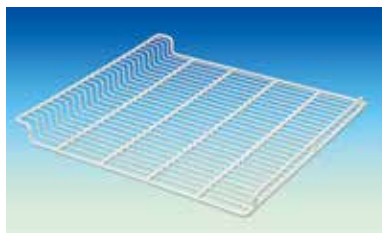

(a) Teflon-coated Steel Wire Shelf



7" Full Touch Screen TFT LCD (Smart-Lab™ Controller)

It is possible to monitor and control the Smart-Lab™ equipment through all smart phone, tablet without restraint of time and place.



WiRe™ App Service

Controlled by Smart-Phone

“ThermoStable™ WLF” Digital Bio Freezer, -35°C ~ -10°C, 320 · 420 · 620Lit

With 3 Shelf, Digital Fuzzy Control System, Fast Freezing Function, CFC-Free Refrigeration, Certi. & Traceability

디지털 저온 냉동고, 디지털 퍼지 컨트롤, 친환경 냉매(134A) 채용, 급속 냉동 기능



Digital Bio Freezer “ThermoStable™ WLF”



with Inner Doors “ThermoStable™ WLF”

- Made in Korea ■ PL(Product Liability) Insurance
- with Certificate & Traceability : Controlled by Serial Number, Certificate, Delivery-information, and Traceable Data Base System
- Digital Fuzzy Control System Implementing Superior Temperature Accuracy
- Fast Freezing Function
- Patented Jog-Shuttle Control System
- CFC-Free (134A) Refrigeration System
- * Suitable for Storage of Bio Reagent, Seed, Enzyme and Various Samples
- * Digital Fuzzy Control System Implementing Superior Temperature Accuracy
- * Storage Function : Set Values of Temperature and Timer
- * Digital LCD with Back-Light Function
- * Locking Mode supported for Experimental Safety (Input to Jog-Shuttle can be Disabled)
- * Intelligent Control of Refrigerator for Preventing Overload of Compressor
- * Corrosion Resistant 304 Stainless-steel Chamber and Shelves
- * Over Current Protection, Sensor Error Detection, Leakage Breaking

Specifications & Ordering information

Spec.	Model	“WLF-320”	“WLF-420”	“WLF-620”
		Max. Capa. 330 Lit	Max. Capa. 420 Lit	Max. Capa. 600 Lit
Capacity		330 Lit	420 Lit	600 Lit
Type		Upright Type		
Temp. Range & Sensor		-35°C ~ -10°C, PT100		
Temp. Resolution		1°C-Display, 1°C-Control		
Refrigerant & Compressor		CFC-Free(134A) Refrigeration System, 3/4HP	CFC-Free(134A) Refrigeration System, 1HP	
Display		Digital LCD with Back-Light Function		
Controller		Digital Controller with Jog-Shuttle Switch (Turn+Push)		
Shelf (Included)		3 Stainless-steel Shelf(# 304)		
Safety Device		Over Current Protector, Sensor Error Detector, Leakage Breaker		
Material		Stainless-steel (# 304)-Internal, Powder Coated steel-External		
Dimension : Interior & Exterior		600×550×h1,000mm, 820×700×h1,700mm	600×700×h1,000mm, 820×850×h1,700mm	780×800×h1,000mm, 1000×950×h1,700mm
Packing Size & Gross Weight		1,160×910×h2,160mm 290 kg	1,160×1,060×h2,160mm 314 kg	1,340×1,160×h2,160mm 350 kg
Power Consumption		1.7 kW	1.8 kW	1.8 kW
Electrical Reqts.		1 Phase, AC 120 V, 60 Hz or AC 230 V, 50 / 60 Hz		
Cat. No.	230V	DH.WLF00320	DH.WLF00420	DH.WLF00620
	120V	DH.WLF01320	DH.WLF01420	DH.WLF01620
Price, Each. ₩				

* Other Specifications are available upon Customer's Request.

※ 운임 약 ₩ 55,000 별도!

Spare Stainless-steel Flat Shelf

- DH.WLF10320 Flat Shelf, w580×d530mm, “LFS320”, for “WLF-320”
- DH.WLF10420 , w580×d680mm, “LFS420”, for “WLF-420”
- DH.WLF10620 , w760×d780mm, “LFS620”, for “WLF-620”

Ea. Price, ₩

DAIHAN Ultra-Low-Temperature Freezer

Simple, Efficient and Green - UniFreez™ Double Security and Power - DuoFreez™

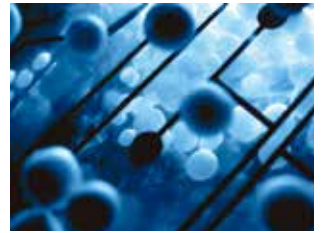

Innovation of Freezing System

I. UniFreez™ Simplified Hi-Efficiency Freezing System

Most of the Ultra-Low Temperature Freezers has two compressors cooperating with each other to drop the internal temperature down to -86°C as shown in the following figure and its overall freezing mechanism is very complicated.

However, our new **UniFreez™** uses only single compressor. Even though, single set of a compressor, a capillary tube, a condenser and an evaporator is incorporated, it ensures the temperature down to -86°C by an advanced control technology of the compressor and the process of specially mixed refrigerants. **UniFreez™** overcomes technical complexity of the typical cascaded double compressor system. Simplification of the freezing mechanism and electricity minimizes the noise, power consumption and failure of operation.

High-Efficiency ! User Safety ! Energy Saving ! Long Life time !

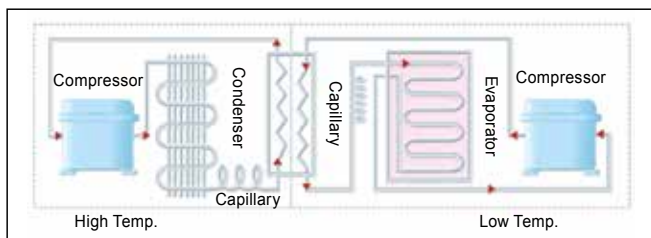

Typical Cascaded Compressor System
Two Freezing cycles contribute Complicated mechanism

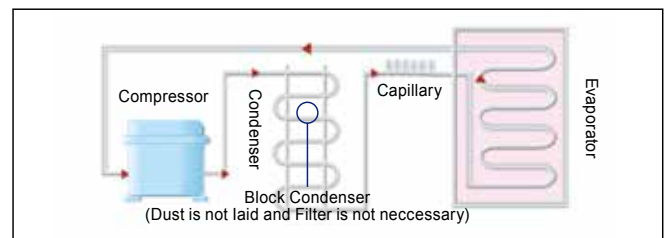

New **UniFreez™ System**
Single freezing cycle works only!!

II. DuoFreez™ Double Security & Robustness Freezing System

We offer an extraordinary high-stability system powered by two **UniFreez™ System** operating independently. Normally, both of the two compressors are running, and it drops the temperature inside the storage chamber down to -95°C . Even if one **UniFreez™ System** fails in operation by a certain unexpected problem, the other **UniFreez™ System** still works and maintains ultra-low temperature down to -80°C . It means one **UniFreez™ System** works as a 'backup' of the other **UniFreez™ System**. This innovative mechanism realizes doubled stability, robustness and fault tolerance, which are the most important feature of the ULT freezer needed by all the customers.

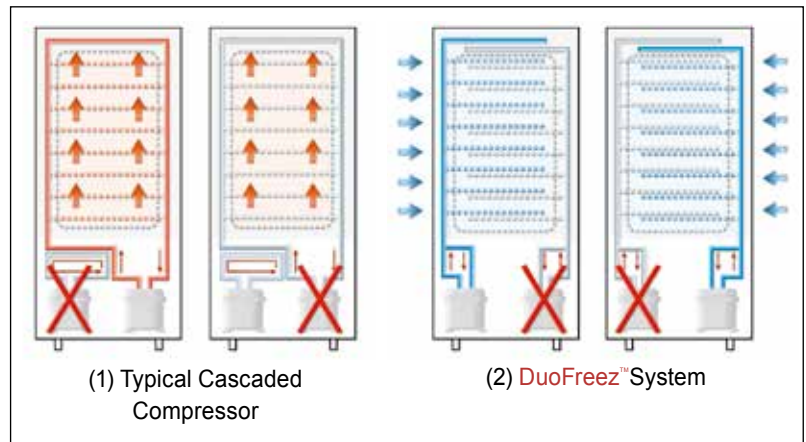

(1) Typical Cascaded
Compressor

(2) DuoFreez™ System

(1) Complicated mechanism

⇒ If one of compressor fails, temperature would go up

(2) Even if one of the two **UniFreez™ systems** fails to run, the other one is still running properly ⇒ **Minimum** -80°C

- ▶ **The lowest temperature of -95°C is ensured by DuoFreez™ system running independently and simultaneously**
- ▶ **Fault Tolerance System**
- Realization of doubled stability and robustness
- ▶ **Incomparable Fast and Powerful Freezing**
- Fast Recovery of Target Temperature

“UniFreez™ U25 & 80” Personal Smart-Lab™ ULT Freezer, **Class-II Medical Device(NIDS)**, -86°C ~ -65°C
 Non-Freon Refrigerants, Upright Type, 개인용 초저온 냉동고, 단일 냉각 시스템, 터치 스크린 LCD 컨트롤러, 친환경 냉매 채용



82Lit Personal ULT Freezer “UniFreez™ U80”,
with Smart-Lab Controller

- Made in Korea
- UL/CUL Certified & GD mark (Only “U80” model)
- CE Certified
- PL (Product Liability) Insurance
- with Certificate & Traceability : Controlled by Serial Number, Certificate, Delivery-information, and Traceable Data Base System
- Personal type Compact Ultra Low Temperature Freezer
- “UniFreez™ U” System can freeze down to -86°C : realize robust and long life time.
- Smart-Lab™ Controller (Only “U80” model)
: Remote Controlled by Smart-Phone with WiRe™ App Service
 - Ergonomic 7” Full Touch Screen TFT LCD
 - Easy Monitoring and Control
 - Internet Connectivity with WiFi
 - Storage Management & Automatic Temp. Data Recording
 - Self-Diagnostic Function : Built in Standard Warning and Alarm Functions
- * Easy Maintenance and Improved Performance
- * High-quality Insulation Panel and Inner Doors ensure defrosting around outer surface.
- * Robust & Flexible design of Door Handle
- * Use of Block Condenser removes filter and causes of related failure.
- * Filter-free Mechanism lowers heat generated by the compressor
- * CFC-free Refrigerants are used
- * External Temp. Sensor Hole
- * Inner Door Height : 252mm (“UniFreez™ U80”)



WiRe™ App Service

It is possible to monitor and control the Smart-Lab™ equipment through all smart phone, tablet without restraint of time and place.

Controlled by Smart-Phone

Specifications & Ordering information

Spec.		Model	“UniFreez™ U25” Max. Capa. 25 Lit	“UniFreez™ U80” Max. Capa. 82 Lit Included 1 Stainless-steel Shelf
Capacity			25 Lit	82 Lit
Temp.	Range	-86°C ~ -65°C		
	Sensor	at Room Temperature of 30°C and Humidity of 70%		
Compressor		PT100 Sensor		
Condenser Type		Hermetic Type		
Refrigerant		Block Condenser, No Pin, Filter Free Mechanism		
Controller		Natural (CFC Free Refrigerant System)		
Shelf (Included)		Digital Feedback Controller		7” Full Touch Screen TFT LCD
Max. Q'ty of Racks		None		1 Stainless-steel Shelf
Material	Internal	None, Only 10~15 boxes are applicable		
	External	4pcs of 12(4×3)-Placed Rack (RFU5234)		
	Inner Door	Stainless-steel (#304)		
Dimension (w×d×h)	Internal (mm)	200×420×300		340×485×520
	External (mm)	390×627×785		530×687×1,060
Weight		52 kg		60 kg
Packing Size (w×d×h) (mm) & Gross Weight		880×860×1,300		960×760×1,350
Power Consumption		69 kg		102 kg
Electrical Reqt.s.		321 w/h		
Cat. No.	230V	1 Phase, AC 120V, 60Hz or AC 230V, 50 / 60Hz		
	120V	DH.WUF0032		DH.SWUF0075
Price, Each. ₩		-		DH.SWUF0175

* Other Specifications are available upon Customer's Request.

※ 운임 약 ₩ 45,000 별도!



25Lit Personal ULT Freezer “UniFreez™ U25”,
with Digital Feedback Controller

Optional Freezer Racks, Boxes, etc. : Please See 195~196 Page

“UniFreez™ U” Smart-Lab™ ULT Freezer, **Class-II Medical Device(NIDS)**, 4 & 5-Door, -86°C ~ -65°C
 Non-Freon Refrigerants, Auto Vacuum Releasing System, 393 · 503 · 714 · 796 Lit, Wire™ Service, Upright-type
 초저온 냉동고, 업라이트형, 단일 냉각 시스템, 터치 스크린 LCD 컨트롤러, 친환경 냉매 채용



SMART Ultra-Low Temperature Freezer,
 “UniFreez™ U800”

- Made in Korea
- UL/CUL & CE Certified
- GD(Good Design)-mark
- PL(Product Liability) Insurance
- with Certificate & Traceability : Controlled by Serial Number, Certificate, Delivery-information, and Traceable Data Base System
- “UniFreez™ U” System can freeze down to -86°C : realize robust and long life time.
- Smart-Lab™ Controller : Remote Controlled by Smart-Phone with WiRe™ App Service
 - Ergonomic 7" Full Touch Screen TFT LCD
 - Easy Monitoring and Control - Eye level Controller
 - Internet Connectivity with WiFi
 - Storage Management & Automatic Temp. Data Recording
 - Self-Diagnostic Function : Built in Standard Warning and Alarm Functions
- * Easy Maintenance and Improved Performance
- * High-quality Insulation Panel and Inner Doors ensure defrosting around outer surface.
- * Automatic Vacuum Breaker - Easy to re-open the Door.
- * Robust & Flexible design of Door Handle
- * Use of Block Condenser removes filter and causes of related failure.
- * Filter-free Mechanism lowers heat generated by the compressor
- * CFC-free Refrigerants are used
- * Inner Door Height : 312mm(4 Door), 252mm(5 Door)
- * External Temp. Sensor Hole
- * Included Shelves : 3ea.(4 Door), 4ea.(5 Door)

Specifications & Ordering information

Spec.		Model	“UniFreez U400” 4 & 5 Door Max. Capa. 393L	“UniFreez U500” 4 & 5 Door Max. Capa. 503L	“UniFreez U700” 4 & 5 Door Max. Capa. 714L	“UniFreez U800” 4 & 5 Door Max. Capa. 796L
Capacity			393 Lit	503 Lit	714 Lit	796 Lit
Temp.	Range		-86°C ~ -65°C		-80°C ~ -65°C	
	Sensor		at Room Temperature of 30°C and Humidity of 70%			
Compressor			PT100 Sensor			
Condenser Type			Hermetic Type			
Refrigerant			Block Condenser, No Pin, Filter Free Mechanism			
Controller & Display			Natural (CFC Free Refrigerant System)			
Shelf (Included)			7" Full Touch Screen TFT LCD (Smart-Lab™ Controller)			
Max. Q'ty of Racks	4-Door		16pcs of 15(5×3)- Placed Rack (RFU4234)	16pcs of 20(5×4)- Placed Rack (RFU4257)	24pcs of 20(5×4)- Placed Rack (RFU4257)	28pcs of 20(5×4)- Placed Rack (RFU4257)
	5-Door		20pcs of 12(4×3)- Placed Rack (RFU5234)	20pcs of 16(4×4)- Placed Rack (RFU5257)	30pcs of 16(4×4)- Placed Rack (RFU5257)	35pcs of 16(4×4)- Placed Rack (RFU5257)
Material	Internal		Stainless-steel (#304)			
	External		Powder Coated steel Plate			
	Inner Door		Powder Coated Stainless-steel (#304)			
Chamber Dimension (w×d×h)	Internal(mm)		600×500×1,310	600×640×1,310	880×620×1,310	980×620×1,310
	External(mm)		840×750×1,900	840×890×1,900	1,120×870×1,900	1,220×870×1,900
Net Weight			210 kg	240 kg	320 kg	350 kg
Packing Size (w×d×h) (cm)			116×116×222	116×124×222	140×140×221	150×140×221
Power Consumption			296 kg	327 kg	442 kg	472 kg
Electrical Reqts.			373 w/h	458 w/h	503 w/h	588 w/h

Smart-Lab™ Controller



7" Full Touch Screen TFT LCD



WiRe™ App Service

It is possible to monitor and control the Smart-Lab™ equipment through all smart phone, tablet without restraint of time and place.

Controlled by Smart-Phone

Cat. No.	4-Door	230V	DH.SWUF00400	DH.SWUF00500	DH.SWUF00700	DH.SWUF00800
		120V	DH.SWUF03400	DH.SWUF03500	DH.SWUF03700	DH.SWUF03800
Price, Each. ₩						
Cat. No.	5-Door	230V	DH.SWUF00450	DH.SWUF00550	DH.SWUF00750	DH.SWUF00850
		120V	DH.SWUF03450	DH.SWUF03550	DH.SWUF03750	DH.SWUF03850
Price, Each. ₩						

* Other Specifications are available upon Customer's Request. ※ 운임 약 ₩ 55,000별도

Optional Freezer Racks, Boxes, etc. : Please See 195~196 Page

“DuoFreez™ U” Smart-Lab™ ULT Freezer, **Class-II Medical Device(NIDS)**, 4 & 5-Door, -95°C ~ -65°C
 Non-Freon Refrigerants, Auto Vacuum Releasing System, Eco Mode, 393 · 503 · 714 · 796 Lit, Upright-type
 초저온 냉동고, 업라이트형, DuoFreez™ System, 7인치 풀터치 스크린 컨트롤러, 친환경 냉매 채용, WiRe™ 서비스



2-Year Warranty

SMART Ultra-Low Temperature Freezer,
 “DuoFreez™ U800”

- Made in Korea
- UL/CUL & CE Certified
- GD(Good Design)-mark
- PL(Product Liability) Insurance
- with Certificate & Traceability : Controlled by Serial Number, Certificate, Delivery-information, and Traceable Data Base System
- DuoFreez™ System can down to -95°C and High-stability System can be Offered : If One System fails in operation, the other System still Maintains down to -80°C
- Smart-Lab™ Controlle: Remote Controlled by Smart-Phone with WiRe™ App Service
 - Ergonomic 7" Full Touch Screen TFT LCD
 - Internet Connectivity with WiFi
 - Easy Monitoring and Control - Eye level Controller
 - Storage Management & Automatic Temp. Data Recording
 - Self-Diagnostic Function : Built in Standard Warning and Alarm Functions
- * External Temp. Sensor Hole
- * CFC-free Refrigerants are used
- * High-quality Insulation Panel and Inner Doors ensure defrosting around outer surface.
- * Automatic Vacuum Breaker - Easy to re-open the Door.
- * Robust & Flexible design of Door Handle
- * Use of Block Condenser removes filter and causes of related failure.
- * Filter-free Mechanism lowers heat generated by the compressor
- * Eco Mode Function for Low Power-consumption.
- * Inner Door Height : 312mm(4 Door), 252mm(5 Door)
- * Included Shelves : 3ea.(4 Door), 4ea.(5 Door)

Specifications & Ordering information

Spec.	Model	“DuoFreez U400” 4 & 5 Door Max. Capa. 393L	“DuoFreez U500” 4 & 5 Door Max. Capa. 503L	“DuoFreez U700” 4 & 5 Door Max. Capa. 714L	“DuoFreez U800” 4 & 5 Door Max. Capa. 796L
Capacity		393 Lit	503 Lit	714 Lit	796 Lit
Freezing System		DuoFreez™ System			
Temp.	Range	-95°C ~ -65°C		-90°C ~ -65°C	
	Sensor	at Room Temperature of 30°C and Humidity of 70%			
		PT100 Sensor			
Compressor		Hermetic Type			
Condenser Type		Block Condenser, No Pin, Filter Free Mechanism			
Refrigerant		Natural (CFC Free Refrigerant System)			
Controller & Display		7" Full Touch Screen TFT LCD (Smart-Lab™ Controller)			
Shelf (Included)		3 Shelf (4 Door), 4 Shelf (5 Door)			
Max. Q'ty of Racks	4-Door	16pcs of 15(5×3)- Placed Rack (RFU4234)	16pcs of 20(5×4)- Placed Rack (RFU4257)	24pcs of 20(5×4)- Placed Rack (RFU4257)	28pcs of 20(5×4)- Placed Rack (RFU4257)
	5-Door	20pcs of 12(4×3)- Placed Rack (RFU5234)	20pcs of 16(4×4)- Placed Rack (RFU5257)	30pcs of 16(4×4)- Placed Rack (RFU5257)	35pcs of 16(4×4)- Placed Rack (RFU5257)
Material	Internal	Stainless-steel (#304)			
	External	Powder Coated steel Plate			
	Inner Door	Powder Coated Stainless-steel (#304)			
Chamber Dimension (w×d×h)	Internal(mm)	600×500×1,310	600×640×1,310	880×620×1,310	980×620×1,310
	External(mm)	840×750×1,900	840×890×1,900	1,120×870×1,900	1,220×870×1,900
Net Weight		260 kg	300 kg	320 kg	360 kg
Packing Size (w×d×h) (cm) & Gross Weight		116×116×222	116×124×222	140×140×221	150×140×221
		352 kg	392 kg	442 kg	482 kg
Power Consumption	Dual mode	474 w/h	507 w/h	596 w/h	629 w/h
	Eco. mode	373 w/h	458 w/h	503 w/h	588 w/h
Electrical Reqts.		1 Phase, AC 120V, 60Hz or AC 230V, 50 / 60Hz			

Smart-Lab™ Controller



7" Full Touch Screen TFT LCD



WiRe™ App Service

It is possible to monitor and control the Smart-Lab™ equipment through all smart phone, tablet without restraint of time and place.

Controlled by Smart-Phone

Cat. No.	4-Door	230V	DH.SWUF01400	DH.SWUF01500	DH.SWUF01700	DH.SWUF01800
		120V	DH.SWUF02400	DH.SWUF02500	DH.SWUF02700	DH.SWUF02800
Price, Each. ₩						
Cat. No.	5-Door	230V	DH.SWUF01450	DH.SWUF01550	DH.SWUF01750	DH.SWUF01850
		120V	DH.SWUF02450	DH.SWUF02550	DH.SWUF02750	DH.SWUF02850
Price, Each. ₩						

* Other Specifications are available upon Customer's Request.

※ 운임 약 ₩ 55,000별도!

Optional Freezer Racks, Boxes, etc.
 : Please See 195~196 Page

“UniFreez™ U” & “DuoFreez™ U” Smart-Lab ULT Freezer, Optional Rack



(1) Sliding Drawer-type Rack, 15 Place
“RFU4234SD”

(1) Optional Freezer Rack, Sliding Drawer-type for 0.5~2ml, 3~4ml, 5ml Vial Box

* Stainless-steel (#304) * without Box

For 2 Door-type U80

Cat. Number	Model	Rack Size(mm) (w×d×h)	Freezer Box & No. of Box	Freezer Capacity (No. of Rack)	Ea. Price, ₩
DH.RFU5234SD	“RFU5234SD”	140×420×232	0.5 ~ 2ml, 12(4×3)	U80 (4ea)	
DH.RFU5434SD	“RFU5434SD”	140×420×171	3 ~ 4ml, 6(2×3)		
DH.RFU5534SD	“RFU5534SD”	140×420×211	5ml, 6(2×3)		

For 4 Door-type U400/U500/U700/U800

Cat. Number	Model	Rack Size(mm) (w×d×h)	Freezer Box & No. of Box	Freezer Capacity (No. of Rack)	Ea. Price, ₩
DH.RFU4234SD	“RFU4234SD”	140×420×290	0.5 ~ 2ml, 15(5×3)	U400(16ea)	
DH.RFU4434SD	“RFU4434SD”	140×420×256	3 ~ 4ml, 9(3×3)		
DH.RFU4534SD	“RFU4534SD”	140×420×311	5ml, 9(3×3)		
DH.RFU4257SD	“RFU4257SD”	140×560×290	0.5 ~ 2ml, 20(5×4)	U500(16ea)	
DH.RFU4457SD	“RFU4457SD”	140×560×256	3 ~ 4ml, 12(3×4)	U700(24ea)	
DH.RFU4557SD	“RFU4557SD”	140×560×311	5ml, 12(3×4)	U800(28ea)	

For 5 Door-type U400/U500/U700/U800

Cat. Number	Model	Rack Size(mm) (w×d×h)	Freezer Box & No. of Box	Freezer Capacity (No. of Rack)	Ea. Price, ₩
DH.RFU5234SD	“RFU5234SD”	140×420×232	0.5 ~ 2ml, 12(4×3)	U400(20ea)	
DH.RFU5434SD	“RFU5434SD”	140×420×171	3 ~ 4ml, 6(2×3)		
DH.RFU5534SD	“RFU5534SD”	140×420×211	5ml, 6(2×3)		
DH.RFU5257SD	“RFU5257SD”	140×560×232	0.5 ~ 2ml, 16(4×4)	U500(20ea)	
DH.RFU5457SD	“RFU5457SD”	140×560×171	3 ~ 4ml, 8(2×4)	U700(30ea)	
DH.RFU5557SD	“RFU5557SD”	140×560×211	5ml, 8(2×4)	U800(35ea)	



(2) Side Access-type Rack, 20 Place
“RFU4257SA”

(2) Optional Freezer Rack, Side Access-type for 0.5~2ml, 3~4ml, 5ml Vial Box

* Stainless-steel (#304) * without Box

for 2 Door-type U80

Cat. Number	Model	Rack Size(mm) (w×d×h)	Freezer Box & No. of Box	Freezer Capacity (No. of Rack)	Ea. Price, ₩
DH.RFU5234SA	“RFU5234SA”	140×420×232	0.5 ~ 2ml, 12(4×3)	U80 (4ea)	
DH.RFU5434SA	“RFU5434SA”	140×420×171	3 ~ 4ml, 6(2×3)		
DH.RFU5534SA	“RFU5534SA”	140×420×211	5ml, 6(2×3)		

for 4 Door-type U400/U500/U700/U800

Cat. Number	Model	Rack Size(mm) (w×d×h)	Freezer Box & No. of Box	Freezer Capacity (No. of Rack)	Ea. Price, ₩
DH.RFU4234SA	“RFU4234SA”	140×420×290	0.5 ~ 2ml, 15(5×3)	U400(16ea)	
DH.RFU4434SA	“RFU4434SA”	140×420×256	3 ~ 4ml, 9(3×3)		
DH.RFU4534SA	“RFU4534SA”	140×420×311	5ml, 9(3×3)		
DH.RFU4257SA	“RFU4257SA”	140×560×290	0.5 ~ 2ml, 20(5×4)	U500(16ea)	
DH.RFU4457SA	“RFU4457SA”	140×560×256	3 ~ 4ml, 12(3×4)	U700(24ea)	
DH.RFU4557SA	“RFU4557SA”	140×560×311	5ml, 12(3×4)	U800(28ea)	

for 5 Door-type U400/U500/U700/U800

Cat. Number	Model	Rack Size(mm) (w×d×h)	Freezer Box & No. of Box	Freezer Capacity (No. of Rack)	Ea. Price, ₩
DH.RFU5234SA	“RFU5234SA”	140×420×232	0.5 ~ 2ml, 12(4×3)	U400(20ea)	
DH.RFU5434SA	“RFU5434SA”	140×420×171	3 ~ 4ml, 6(2×3)		
DH.RFU5534SA	“RFU5534SA”	140×420×211	5ml, 6(2×3)		
DH.RFU5257SA	“RFU5257SA”	140×560×232	0.5 ~ 2ml, 16(4×4)	U500(20ea)	
DH.RFU5457SA	“RFU5457SA”	140×560×171	3 ~ 4ml, 8(2×4)	U700(30ea)	
DH.RFU5557SA	“RFU5557SA”	140×560×211	5ml, 8(2×4)	U800(35ea)	



(1) ~ (3) White Box



(4) 5 Color Assorted Box-Set



(5) 5 Color Hinged Box



C11.001

C11.002

(6) Hard Board Storage Box

Optional Cardboard Freezer Box

(1) for 0.5~2ml Cryovial/Microtube, 81 & 100 hole White Box, h52mm
0.5ml : Screwcap Microtube

SL.Box9001 81-hole Box , White, h52mm, Cell ϕ 15mm
SL.Box9002 100-hole Box, White, h52mm, Cell ϕ 12.5mm

Ea.	Price, ₩	Cs.	Price, ₩
		100ea	
		100ea	

(2) for 3ml Cryovial, 81 & 100 hole White Box, h77mm
Maybe fit to 4ml Cryovial

SL.Box9003 81-hole Box , White, h77mm, Cell ϕ 15mm
SL.Box9004 100-hole Box, White, h77mm, Cell ϕ 12.5mm

Ea.	Price, ₩	Cs.	Price, ₩
		100ea	
		100ea	

(3) for 5ml Cryovial, 64 & 81 hole White Box, h98mm

SL.Box9007 64-hole Box, White, h98mm, Cell ϕ 16mm
SL.Box9008 81-hole Box, White, h98mm, Cell ϕ 15mm

Ea.	Price, ₩

(4) for 0.5~2ml Cryovial & Microtube, 5 Color Assorted Box-Set, 81 & 100 hole
5 Colors : Blue / Green / Pink / Yellow / White-Assorted

SL.Box9005 81-hole/5 color Box set , h52mm, Cell ϕ 15mm
SL.Box9006 100-hole/5 color Box set, h52mm, Cell ϕ 12.5mm

Set.	Price, ₩	Cs.	Price, ₩
5ea		25set	
5ea		25set	

(5) for 0.5~2ml Cryovial & Microtube, ID-Color™ 81hole
Cell ϕ 15mm 5 Color Cardboard Freezer Box-set

* 5 Assored Color : Blue · Green · Orange · White · Yellow, 20ea/cs(4Pk × 5Color)

SL.Box9014 Freezer Box, 81-hole, for 0.5~2.0ml, 5 Assorted Color

dh Pk.	Price, ₩	Cs.	Price, ₩
5ea		20ea	
		* 5color assorted 4pk.	

(6) for 1.5/2.0ml Cryovial/ Microtube, 81-Holes Cell ϕ 15mm Hard Board Storage Box
with Hard Board / PP Divider

C11.001 Hard Board Box, with Hard Board Divider, 81 Hole, 133 × 133 × h52 mm
C11.002 , with PolyPropylene Divider, 81 Hole, 133 × 133 × h52 mm

Ea.	Price, ₩

Optional Recorder/Remote Alarm System/LCO₂ Back up System



(1) Temp. Chart Recorder, "KT622"



(2) Chart Paper, "C657", 60 charts for 420 days



(3) Replacement Pens 6ea, Red color, "P222", for Cart Recorder



(4) LCO₂ back up system "LCO2B"



(5) Remote Alarm System "RWAS"

DH.KT622 (1) Temp. Chart Recorder, "KT622", with "C657" Chart Paper
DH.C657 (2) Chart Paper, "C657", 60 Charts, for 420 days recording
DH.P222 (3) Replacement Pens, "P222", 6ea Red color, for "KT622" Chart Recorder
DH.LCO2B (4) LCO₂ Back up System, "LCO2B"
DH.RWAS (5) Remote Wire/Wireless Alarm System, "RWAS"

Ea.	Price, ₩

ULT Freezer with Validation (IQ, OQ) Service

DH.SWUF30400 Validation Service(IQ, OQ), with "UniFreez U400", "SUFV400"
DH.SWUF30500 U500, "SUFV500"
DH.SWUF30700 U700, "SUFV700"
DH.SWUF30800 U800, "SUFV800"
DH.SWUF31400 Validation Service(IQ, OQ), with "DuoFreez U400", "SUFDV400"
DH.SWUF31500 U500, "SUFDV500"
DH.SWUF31700 U700, "SUFDV700"
DH.SWUF31800 U800, "SUFDV800"
DH.WUF30032 Validation Service(IQ, OQ), with "UniFreez U25", "UFV32"
DH.SWUF30075 U80, "SUFV75"

Ea.	Price, ₩

Safety Cabinet

Safety Cabinet, For Chemicals P.198~200
, For Flammables P.201

**Ducted PP Safety Cabinet
for Chemicals**
“FGC-2001”



**PP Safety Cabinet
for Strong Acid & Corrosives**
2 Doors, 170Lit



**Safety Cabinet
for Acid & Corrosives**
Single Door, 45Lit



**Safety Cabinet
for Flammables**
Single Door, 45Lit

DAIHAN® Ducted Safety Cabinet, with Clear PVC-/Safety Glass-Door Window, Built-in PP/Al-buttruss
With Internal & External PP/Steel Plate, Duct & Pipe Silicon Sealing, Gas Leak Completely Blocked, 덕트형 약품기구 보관장, 환기형

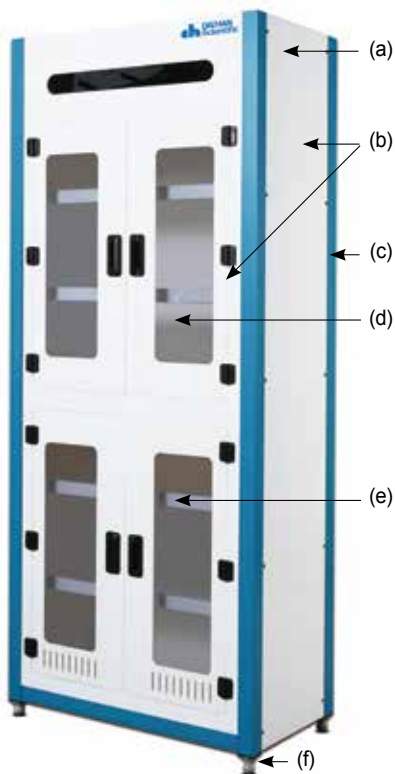

(1) PP Safety Cabinet, "FGC-2001"

- **Made in Korea** ■ **Durable, Hazardous Chemical Gas Remove.**
- **Internal / External PP Sheet / Steel Plate Good Resistance of Chemicals & Acid.**
- **Clear PVC-/Tempered Safety Glass-Window**
(Custom-Made Safety Cabinet : Wide Variety of Material for User Selection)

- * Discharging Toxic Gas Generated During Storage Various Reagents to the Outside through the Duct Structure
- * Effective in Maintaining a Comfortable indoor to Prevent the Laboratory Room Air being Polluted.
- * It may Create a Space to Treat the Harmful Substances in the Human Body Safely and Comfortably
- * Process Pipe & Duct Silicon Sealing to Completely Block the Gas Leakage to the Outside
- * Optional Blower User Selection : External-model(Stainless steel-/ Steel-/ PVC-/ PP-Blower) & Internal-model(Steel-/ PVC-/ PP-Blower)
- * Optional 24-hour Timer : Automatically Adjustable Exhaust attached to a Safety Cabinet

(1) Ducted PP Safety Cabinet, Clear PVC Door Window

- **Internal / External PP Material Resistance of Chemicals and Acids**
- **Built-in PP-buttruss** ■ **1-Room, 4-Door, 5-Shelf**

- * Safe Storage of Chemicals and Acids
- * Door Window : Use the Clear PVC Transparency and Protect the Experimenter Against the Risk of Explosion.
- * Basic Materials of Construction : Internal(PP), External(PP), 5-stage a Fixed Shelf(PP)

Specifications & Ordering information

Spec.	Model	"FGC-2001" Length. 900mm	"FGC-2003" Length. 1200mm	"FGC-2005" Length. 1500mm
(a) Duct size		φ 100mm / φ 150mm		
(b) Body & Door Material		PP		
(c) Column Material		PVC		
(d) Door Window Material		Clear PVC		
(e) Shelf Material		PP (5 Fixed-type)		
(f) Foot Material		PVC(Height Adjustable up to 30mm)		
Dimension(w × d × h)		900 × 500 × h2100mm	1200 × 500 × h2100mm	1500 × 500 × h2100mm
Power Supply		220V / 60Hz		
Cat. No.		DH.FGC2001	DH.FGC2003	DH.FGC2005
Price, Ea. ₩				

* Other Specifications are available upon Customer's Request.

※ **Note! Freight and Installation Charges Separately.**

(2) Ducted Steel Safety Cabinet, Tempered Safety Glass Door Window

- **Internal/External Steel plate with Powder finished for Resistance of Chemicals**
- **Built-in Particle Board-plate & Al-buttruss** ■ **1-Room, 2-Door, 5-Shelf**

- * Safe Storage of Chemicals
- * Use Tempered Safety Glass Protects the Experimenter Against the Risk of Explosion.
- * Basic Materials of Construction : Internal(Steel), External(Steel), 5-stage a Fixed Shelf(PB & Al)

Specifications & Ordering information

Spec.	Model	"FGC-900" Length. 900mm	"FGC-1200" Length. 1200mm	"FGC-1500" Length. 1500mm
(a) Duct size		φ 100mm / φ 150mm		
(b) Body & Door Material		Steel(with Powder Finished)		
(c) Door Window Material		Tempered Safety Glass		
(d) Shelf Material		PB(Particle Board) Plate + Aluminum Buttress (5 Fixed-type)		
(e) Foot Material		Stainless-steel(Height Adjustable up to 30mm)		
Dimension(w × d × h)		900 × 500 × h2100mm	1200 × 500 × h2100mm	1500 × 500 × h2100mm
Power Supply		220V / 60Hz		
Cat. No.		DH.FGC0900	DH.FGC1200	DH.FGC1500
Price, Ea. ₩				

* Other Specifications are available upon Customer's Request.

※ **Note! Freight and Installation Charges Separately.**

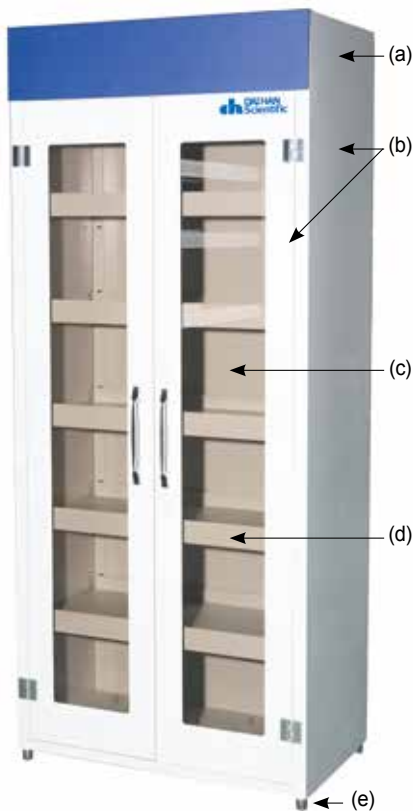

(2) Steel Safety Cabinet, "FGC-900"

Zoyet® Safety Cabinet for Acid & Corrosives, with Double Layer Fire Proof Steel, Insulation Layer, 15~410 Lit For Easy Open & Close 180° Door with Double Key, with Steel Shelf, Optional PP Tray, with Manual-/Self Closing-Door Compliance with OSHA 29 CFR 1910.106 and NFPA CODE 30, 안전 케비닛, 산 또는 부식성 시약 보관용



- Complies with OSHA 29 CFR 1910.106, NFPA CODE 30 and FM Standard.
- Safe Construction ;

- Complete Double Layer Fire Proof Sheet Steel, 38mm of Insulation Layer between Double Layer Wall Space.
- Sheet Steel of Thickness over 1.0mm All-welded Together making it more Durable and Robust.
- Inside and Outside surface of Cabinet is finished on Blue Permanent and Corrosion-resistant Paints.
- Spill Control Sill of 5cm Height prevent Maximum Leak Control on Accidental Spill.
- 3-point Inter-active Locking System Provides Easy, Fail-safe, Positive Door Closure.
- Easy open-close 180° Cabinet Door with Double Keys



■ Special Features ;

- (a) Fully Welded, not Riveted Construction holds Squareness for Long Life and offers greater Protection in a Fire since Air Gaps are reduced.
- (b) Inside and Outside surface of Cabinet is finished on Blue Permanent and Corrosion-resistant Paints.
- (c) Highly Secure Lock with Dual Protection (Padlock and Key lock) makes Storage Safer.
- (d) Dual Vents with Built-in Flash Arresters Strategically placed at Bottom and Opposite Top.
- (e) 5cm Leakproof Containment Sump holds Leaks and meets US EPA Requirements.
- (f) Adjustable Leveling Feet make it easy to Balance Cabinets on Uneven Surface.
- (g) Label makes it Apparently Visible for Site Manager or Operators to identify where the Chemicals stored quickly.
- (h) Continuous Piano Hinge provides better Open-close Smooth Operation, ensuring Endurance and Reliability.

※ Note! Freight and Installation Charges Separately.



(1), (3) Single Door, 45Lit

(1), (3) Single Door, 83Lit

(1) with Manual-closing Single Door, 15~83 Lit Shelf Capacity : 50kg

Cat. No.	Description	Dimensions & Weight	Price, Ea. ₩
HW.ZYC0004B	1 Door, Manual, 1 Shelf, 15Lit	w430×d430×h560mm , 35kg	
HW.ZYC0012B	, 45Lit	w590×d460×h890mm , 56kg	
HW.ZYC0022B	, 2 Shelf, 83Lit	w590×d460×h1650mm, 85kg	

(2) with Manual-closing 2 Door, 114~410 Lit Shelf Capacity : 100kg

Cat. No.	Description	Dimensions & Weight	Price, Ea. ₩
HW.ZYC0030B	2 Door, Manual, 1 Shelf, 114Lit	w1090×d460×h1120mm, 100kg	
HW.ZYC0045B	, 2 Shelf, 170Lit	w1090×d460×h1650mm, 138kg	
HW.ZYC0060B	, 227Lit	w860×d860×h1650mm , 165kg	
HW.ZYC0090B	, 340Lit	w1090×d860×h1650mm, 190kg	
HW.ZYC0110B	, 410Lit	w1500×d860×h1650mm, 270kg	

(3) with Self-closing Single Door, 15~83 Lit Shelf Capacity : 50kg

Cat. No.	Description	Dimensions & Weight	Price, Ea. ₩
HW.ZYC0004BS	1 Door, Self-closing, 1 Shelf, 15Lit	w430×d430×h560mm , 35kg	
HW.ZYC0012BS	, 45Lit	w590×d460×h890mm , 56kg	
HW.ZYC0022BS	, 2 Shelf, 83Lit	w590×d460×h1650mm, 85kg	

(4) with Self-closing 2 Door, 114~410 Lit Shelf Capacity : 100kg

Cat. No.	Description	Dimensions & Weight	Price, Ea. ₩
HW.ZYC0030BS	2 Door, Self-closing, 1 Shelf, 114Lit	w1090×d460×h1120mm, 100kg	
HW.ZYC0045BS	, 2 Shelf, 170Lit	w1090×d460×h1650mm, 138kg	
HW.ZYC0060BS	, 227Lit	w860×d860×h1650mm , 165kg	
HW.ZYC0090BS	, 340Lit	w1090×d860×h1650mm, 190kg	
HW.ZYC0110BS	, 410Lit	w1500×d860×h1650mm, 270kg	

(5) Spare Steel Shelf for Flammable / Acid & Corrosives Safety Cabinet

Cat. No.	Description	Ea.	Price, ₩
HW.GB0004	Steel Shelf, for 15Lit Cabinet , w340×d340×h28mm		
HW.GB0012	, for 45/83Lit Cabinet , w500×d370×h28mm		
HW.GB0030	, for 114/170Lit Cabinet, w1000×d370×h28mm		
HW.GB0060	, for 227Lit Cabinet , w770×d770×h28mm		
HW.GB0090	, for 340Lit Cabinet , w1000×d770×h28mm		
HW.GB0110	, for 410Lit Cabinet , w1400×d770×h28mm		

(6) Optional PP Tray for Acid & Corrosives Safety Cabinet

Cat. No.	Description	Ea.	Price, ₩
HW.PPGB0004	PP Tray, for 15Lit Cabinet , w330×d330×h35mm		
HW.PPGB0012	, for 45/83Lit Cabinet , w490×d360×h35mm		
HW.PPGB0030	, for 114/170Lit Cabinet, w990×d360×h35mm		
HW.PPGB0060	, for 227Lit Cabinet , w760×d760×h35mm		
HW.PPGB0090	, for 340Lit Cabinet , w1000×d760×h35mm		
HW.PPGB0110	, for 410Lit Cabinet , w1390×d760×h35mm		

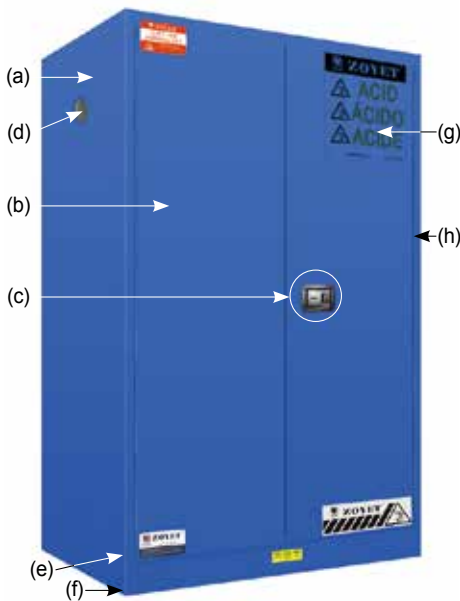

(2), (4) for Acid & Corrosives, 2 Door, 340Lit



(5) Spare Steel Shelf



(6) Optional PP Tray

Zoyet® PP Safety Cabinet for Strong Acid & Corrosives, with Liquid-tight, with All-welded Interior, 15~170 Lit
According to OSHA Requirement, with White Durable Polypropylene, PP 안전 케비닛, 산 & 부식물질 보관용



(1) PP, Single Door, 15Lit

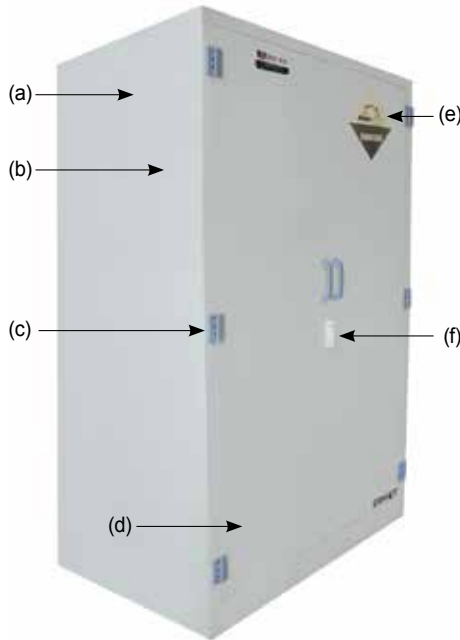

(2) PP, 2 Door, 170Lit



(3) Spare PP Shelf (4 Hooks included)

- Meets OSHA Requirement for Secondary Containment.
- White Durable Polypropylene Cabinet is intended to store Acid and Corrosive Substance, such as Example, Sulfuric Acid, Hydrochloric Acid, Acetic Acid, Nitric Acid, Sodium Hydroxide, Potassium Hydroxide etc.
- Store the most Corrosive Chemicals with no fear of Rust or Corrosion of the Storage Cabinet.
- All Cabinets have Liquid-tight, All-welded Interior to Contain Accidental Spills.
- Special Features ;
 - (a) PP Cabinet Body adopts High Quality Anti-shock White PP board of 8mm Thickness, Welded as a Whole with Same Property and Color Welding Bar.
 - (b) Equipped with Internationally recognized Leakage Proof Shelf, which could be detached out to be cleaned. Adjustable Shelf
 - (c) PP Hinges for Durability and Long Life.
 - (d) Cabinet Door could be customized as Left-open or Right-open.
 - (e) Cabinet Doors are marked clearly with Warning Label Reading "CORROSIVE".
 - (f) To improve Operational Safety, Padlock could be used to provide Extra Protection.

※ Note! Freight and Installation Charges Separately.

(1) Manual-closing Single Door, 15~45 Lit Shelf Capa. : 25kg(for 15L), 30kg(for 45L)

Cat. No.	Description	Dimensions & Weight	Price, Ea. ₩
HW.ZYP0004	1 Door, Manual, 1 Shelf, 15Lit	w430×d430×h560mm, 11kg	
HW.ZYP0012	, 45Lit	w590×d460×h890mm, 25kg	

(2) Manual-closing 2 Door, 100~170 Lit Shelf Capa. : 35kg(for 100L), 40kg(for 114/170L)

Cat. No.	Description	Dimensions & Weight	Price, Ea. ₩
HW.ZYP0026	2 Doors, Manual, 1 Shelf, 100Lit	w910×d600×h900mm , 46kg	
HW.ZYP0030	, 114Lit	w1090×d460×h1120mm, 52kg	
HW.ZYP0045	, 2 Shelf, 170Lit	w1090×d460×h1650mm, 75kg	

(3) Spare PP Shelf for Acid & Corrosives PP Safety Cabinet

- HW.PPS04 PP Shelf, for 15Lit Cabinet, w405×d345×h78mm
- HW.PPS12 , for 45Lit Cabinet, w565×d375×h78m
- HW.PPS26 , for 100Lit Cabinet, w885×d515×h78mm
- HW.PPS30 , for 114 & 170Lit, Cabinet, w1065×d375×h78mm

Ea.	Price, ₩



Polypropylene (PP) Safety Cabinet for Acid & Corrosives

Zoyet® Safety Cabinet for Flammables, with Double Layer Fire Proof Steel with Insulation Layer, 15~410 Lit
For Easy Open & Close 180° Door with Double Key, with High Visible Warning Label, with Manual-/Self Closing-Door
Compliance with OSHA 29 CFR 1910.106 and NFPA CODE 30, 안전 케비닛, 인화성 시약 보관용



■ Complies with US OSHA 29 CFR 1910.106, NFPA CODE 30 and FM Standard

■ Safe Construction ;

- Complete Double Layer Fire Proof Sheet Steel, 38mm of Insulation Layer between Double Layer Wall Space.
- Sheet Steel of Thickness over 1.0mm All-welded Together making it more Durable and Robust, with Better Fire Proof Capacity.
- Galvanized Steel Shelves direct Spills to Back and Bottom of a Leakproof 50mm/150mm Bottom Sump.
- Spill Control Sill of 5cm Height prevent Maximum Leak Control on Accidental Spill.
- 3-point Inter-active Locking System Provides Positive Closure with Increased Heat Resistance.
- Easy open-close 180° Door with Double Keys (Padlock and Key Lock)
- Built-in Grounding Connector on Outside Side Panel for Easy Grounding

■ Special Features ;

- (a) Fully Welded, not Riveted Construction holds Squareness for Long Life and offers greater Protection in a Fire since Air Gaps are reduced.
- (b) Safety Shelves direct Spills to back and Bottom of Leakproof Sump. Adjustable on 60mm Centers, they meet ANSI Standards with a 99kg Theoretically Allowable Load.
- (c) Highly Secure Lock with Dual Protection (Padlock and Key lock) makes Storage Safer.
- (d) Dual Vents with Built-in Flash Arresters Strategically placed at Bottom and Opposite Top.
- (e) 5cm Leakproof Containment Sump holds Leaks and meets US EPA Requirements.
- (f) Adjustable Leveling Feet make it easy to Balance Cabinets on Uneven Surface.
- (g) Label makes it Apparently Visible for Site Manager or Operators to identify where the Chemicals stored quickly.
- (h) Continuous Piano Hinge provides better Open-close Smooth Operation, ensuring Endurance and Reliability.
- (i) Durable and Chemical-resistant, Lead-free Powder-coat Paint Finish, Inside and Out, retains High Gloss Look and minimizes the Effects of Corrosion and Humidity.



(1), (3) for Flammables, Single Door, 15Lit



(2), (4) for Flammables, 2 Door, 114Lit

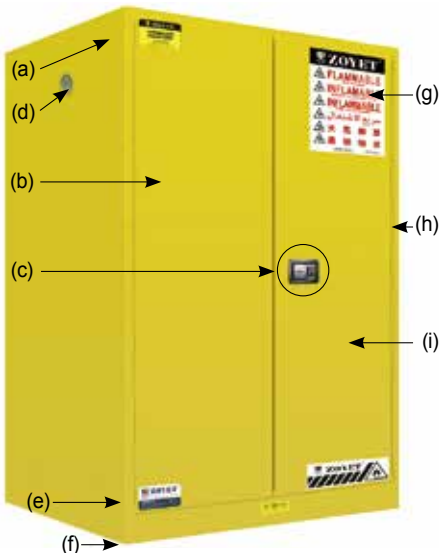

(2), (4) for Flammables, 2 Door, 340Lit



(5) Spare Steel Shelf

※ Note! Freight and Installation Charges Separately.

(1) with Manual-closing Single Door, 15~83 Lit, Shelf Capacity : 50kg

Cat. No.	Description	Dimensions & Weight	Price, Ea. ₩
HW.ZYC0004	1 Door, Manual, 1 Shelf, 15Lit	w430×d430×h560mm , 35kg	
HW.ZYC0012	, 45Lit	w590×d460×h890mm , 56kg	
HW.ZYC0022	, 2 Shelf, 83Lit	w590×d460×h1650mm, 85kg	

(2) with Manual-closing 2 Door, 114~410 Lit, Shelf Capacity : 100kg

Cat. No.	Description	Dimensions & Weight	Price, Ea. ₩
HW.ZYC0030	2 Doors, Manual, 1 Shelf, 114Lit	w1090×d460×h1120mm, 100kg	
HW.ZYC0045	, 2 Shelf, 170Lit	w1090×d460×h1650mm, 138kg	
HW.ZYC0060	, 227Lit	w860×d860×h1650mm , 165kg	
HW.ZYC0090	, 340Lit	w1090×d860×h1650mm, 190kg	
HW.ZYC0110	, 410Lit	w1500×d860×h1650mm, 270kg	

(3) with Self-closing Single Door, 15~83 Lit, Shelf Capacity : 50kg

Cat. No.	Description	Dimensions & Weight	Price, Ea. ₩
HW.ZYC0004S	1 Door, Self-closing, 1 Shelf, 15Lit	w430×d430×h560mm , 35kg	
HW.ZYC0012S	, 45Lit	w590×d460×h890mm , 56kg	
HW.ZYC0022S	, 2 Shelf, 83Lit	w590×d460×h1650mm, 85kg	

(4) with Self-closing 2 Door, 114~410 Lit, Shelf Capacity : 100kg

Cat. No.	Description	Dimensions & Weight	Price, Ea. ₩
HW.ZYC0030S	2 Doors, Self-closing, 1 Shelf, 114Lit	w1090×d460×h1120mm, 100kg	
HW.ZYC0045S	, 2 Shelf, 170Lit	w1090×d460×h1650mm, 138kg	
HW.ZYC0060S	, 227Lit	w860×d860×h1650mm , 165kg	
HW.ZYC0090S	, 340Lit	w1090×d860×h1650mm, 190kg	
HW.ZYC0110S	, 410Lit	w1500×d860×h1650mm, 270kg	

(5) Spare Steel Shelf for Flammable / Acid & Corrosives Safety Cabinet

HW.GB0004	Steel Shelf, for 15Lit Cabinet	, w340×d340×h28mm
HW.GB0012	, for 45/83Lit Cabinet	, w500×d370×h28mm
HW.GB0030	, for 114/170Lit Cabinet,	w1000×d370×h28mm
HW.GB0060	, for 227Lit Cabinet	, w770×d770×h28mm
HW.GB0090	, for 340Lit Cabinet	, w1000×d770×h28mm
HW.GB0110	, for 410Lit Cabinet	, w1400×d770×h28mm

Ea.	Price, ₩

Shaker

Mixer, Rocker	P. 204
, Rotor	P. 204
, Vortex	P. 203~204
Shaker, Orbital Motion	P. 205~207
, Reciprocating Motion	P. 207~208
, Rocker	P. 209
, Rotator	P. 210

● **Mixer, Vortex**



● **Mixer, Tube Mix Rotor**



● **Shaker, Rocker**



● **Shaker, Orbital/Reciprocating**



● **Shaker, Rotator**



DAIHAN® Hi-performance Multifunction Vortex Mixer-set "MaXshake™ VM30", 3,300rpm, with Certi. & Traceability
With ϕ 76mm(3inch) Platform Head & Pop-off Cup Head, Variable Speed Control, Continuous or Touch-on Mixing
다용도 볼텍스 믹서, 다양한 속도 조절, 인체공학적인 디자인 적용, 강력하고 안정된 동작과 저소음



Multifunction Vortex Mixer Set "MaXshake™ VM30" with ϕ 76mm(3") Platform(PM110)

- Made in Korea
- PL (Product Liability) Insurance
- with Certificate & Traceability : Controlled by Serial Number, Certificate, Delivery-information, and Traceable Data Base System
- Ideal for Mixing Solutions in Test Tubes or Small Flasks with Circular, Oscillating Movement
- Variable Speed Control Allows Slow Speed Shaking Action up to High Speed Vortexing

- * Gentle Mixing to Re-suspending Pellet
- * Ergonomic Design with Stable Low Profile Body.
- * A Robust and Sturdy Diecast Construction Vortex Mixer.
- * Exceptional Stability on the Bench Thanks to the Combination of Weight and Non-slip Feet.
- * Variable Speed up to 3,300rpm.
- * Continuous-run or Touch-activated Run Modes.
- * Variable Speed for Gentle to Vigorous Mixing.
- * Powerful Motor for Efficient Mixing
- * Circular Orbit for an Effective Vortex at any Speed
- * Constant Torque within the Full Range of Speed.
- * Eccentric with Oil-less Ball Bearings
- * Optimized Counter Balance System Minimizes Vibration.
- * Counter Balance Design for Minimal Body Vibration.
- * Special Designed Silicon Feet Absorb Vibration at High Speeds.
- * Speed Regulation through Knob provided on the Control Panel
- * Electronic Speed Control for Constant Speed even during Changes in Load
- * Conical Tube can be Mixed Smoothly by Hand Holding.
- * One Mixing Head for a Variety of Tube Sizes
- * Universal Head for a Variety of Mixing Applications
- * Accepting Vessels up to 76mm Diameter
- * MBR(Methyl Methacrylate Butadiene Rubber) Feet for Ultra Stability and Vibration Damping

Specifications & Ordering information

Spec.	Model	"MaXshake™ VM30"
Speed Range		0 ~ 3,300 rpm
Shaking Motion		Orbital, Circuit Orbit : 4.0mm
Control		Analog Phase Controller
Motor		Brushless AC Motor
Head (Included)		Pop-off Cup Head and ϕ 76mm Platform Head
Max. Load		0.5kg
Material		Aluminum Die-casting with Powder Coating
Dimensions (w × d × h) (mm)		140 × 190 × h123 mm
Weight		3 kg
Others		3-position Power Switch Operates Aluminum Die-casting with Powder Coating
Packing Dimension (w × d × h) (mm)		175 × 255 × h215 mm
Gross Weight		3 kg
Power Consumption		30 W
Electrical Reqts.		1 Phase, AC 120V, 50 / 60Hz or AC 230V, 50 / 60Hz

Cat. No.	230V	60Hz	DH.WVM00030
		50Hz	DH.WVM00031
	120V	60Hz	DH.WVM00032
		50Hz	DH.WVM00033
Price, Each. ₩			

* Other Specifications are available upon Customer's Request.

Spare Platform Head

- DH.WVM00110 (1) Platform Head, "PM110", ϕ 76mm(3inch)
- DH.WVM00210 (2) Pop-off Cup Head, "PM210"

Ea. Price, ₩

Optional Platform Head

- DH.WVM00310 (3) Microtube Platform Head(0.5~2.0ml), "PM310"

Ea. Price, ₩

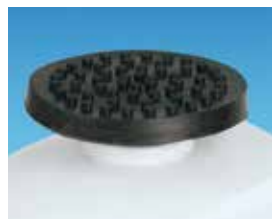

(1) Platform Head, ϕ 76mm(3inch) "PM110" (Included)



(2) Pop-off Cup Head "PM210" (Included)



(3) Microtube Platform Head, 0.5~2.0ml Tube "PM310" (Optional)



Remove Applicator (Included)

DAIHAN® Mini Vortex Mixer “VM-100”, Up to 3,200rpm
 With Silicone Head, Space Saving Compact Design, Variable Speed Control, 소형 볼텍스 믹서



- **Quality Certification : ISO 9001**
- **Ideal for Mixing Solutions in Test Tubes Oscillating Movement**
- * Mini Size saved the Space of Working Desk
- * Variable Speed Control and Automatically Press Start
- * Powerful and Quiet Vortex Mixing Action for Tubes up to 50ml
- * Blue/Orange Silicon Top Head
- * Max. Speed : 3,200 rpm * Orbit : 4.5mm
- * Overall Dimension & Weight(N.W./G.W.) : 55×173×h81 mm, 0.77 / 0.9 kg

DH.WVM0100.B Mini Vortex Mixer, “VM-100”, for 230V, Blue Silicon Head
DH.WVM0100.O , Orange Silicon Head

Ea. Price, ₩

DAIHAN® Compact Multifunction Mixer/Rocker “MixM-100”, Smoothly Rocking Motion, 24rpm
 With Rubber Cushion Platform, Continuous Operation, Ideal for Dishes(≥ ϕ 100mm) or 1.5~50ml Tubes, 소형 다기능 믹서-락커



- **Quality Certification : ISO 9001.**
- **Ideal for Dishes(≥ ϕ 100mm) and 1.5 ~ 50ml Tubes.**
- **Capacity ; 3ea - ϕ 100mm Dishes, or 30ea - 1.5ml Microtubes, or 15ea - 15ml Tubes, or 8ea - 50ml Tubes.**
- **Easy to load and unload the Test Tubes without Turning the Mixer Off.**
- **Rubber Cushion preventing the Test Tubes from Slipping.**
- * Widely used in Hematology, Chemistry, Research and Bacteriology Laboratories.
- * Smooth, Steady, Quiet, and Continuous Operation
- * Speed : 24rpm at 60Hz / 20rpm at 50Hz
- * Platform Dimension : w300×d115 mm
- * Overall Dimension & Weight(N.W./G.W.) : w350×d140×h110 mm, 1.5 / 2.0 kg

DH.MixM0100 Compact Mixer/Rocker, “MixM-100”, for 230V
DH.MixM0101 , “MixM-101”, for 120V

Ea. Price, ₩

DAIHAN® Tube Mix Rotor “MixR-40”, with 5× Mixing Rollers, Rocking & Rolling-motion, Fixed 40rpm
 Ideal for 15~50ml Test Tube, with Timer/Minimum Noise Motor/Cooling Pan/0~60min Timer, 튜브 믹싱 로터



- **Made in Korea** ■ **with 5× Mixing Rollers(ϕ 32×L325mm)**
- **Ideal for Mixing Blood Samples, Viscous Substances and Liquid-Solid Suspensions, Use in a Variety of Applications, Prevention of Blood Coagulation and Immune Precipitation, etc.**
- **Rocking & Rolling Mixing-motion for Complete Sample Mixing**
- * Stability Mixing Motion and Built in Minimize Noise AC Synchronous Motor
- * Built in Cooling Pan Protecting Over Temperature for Long Operating Time.
- * Can Use with 8ea× 15ml Test Tubes or 8ea× 50ml Test Tubes.
- * Stability Fixed 40rpm Mixing Speed
- * Built in 99hr 59min Timer for User Convenience
- * Can be Used in Cold Lab Chambers or Incubators

Specifications & Ordering information

Spec.	Model	“MixR-40”
No. of Mixing Roller		5ea× Mixing Rollers
Mixing Roller Size & Material		ϕ 32×L325 mm, PVC
Mixing Speed		Fixed 40rpm
Motor		AC Synchronous Motor, 12W
Timer		0~60min Analog Timer/Continuous Run
Material(Body)		Powder-coated Steel
Dimension & Weight		490×220×h100 mm, 3 kg
Electric Reqts.		AC 230V, 50/60Hz
Cat. No.		DH.MixR1040
Price, Each. ₩		

DAIHAN® Analog Orbital Shaker "ShkO-300", 10 Levels Speed Control/40~300rpm
With Standard Rubber Mat Platform, 0~60min Timer, 궤도형 셰이커



Orbital Shaker "ShkO-300"

- Made in Korea
 - Stepless Speed Controller(10Levels Speed/40~300rpm)
 - Ideal for Culturing Cells to Hybridization, Staining and Destaining Gels, and Combinatorial Chemistry, etc.
 - Included Rubber Mat Platform
 - Optional PCR Plate- / Universal Perforated-Platform
- * Brushless DC Motor : Low Noise and Long Life time
* Optimal Platform Rotation for Intensive Mixing
* Built in 0~60min Timer for User Convenience

Specifications & Ordering information

Spec.	Model	"ShkO-300"
Speed Range		40~300 rpm, 10 Levels Speed Control
Shaking Motion		Orbital Motion
Motor		20W DC 12V Motor
Timer		0~60min Analog Timer/Continuous Run
Platform Size		285 × 285 × h10 mm
Material		Powder-coated Steel
Dimension (w × d × h)		250 × 280 × 180mm
Net Weight		7 kg
Packing Size (w × d × h) & Gross Weight		320 × 350 × 250mm 7.5 kg
Electric Reqts.		AC 230V, 50/60Hz
Cat. No.		DH.ShkO1300
Price, Each. ₩		



(1) PCR Plate Platform
(Optional)



(2) Universal Perforated
Platform and STS Wire Spring
Flask Holders
(Optional)

Optional or Spare Platform/Flask Holder

- DH.ShkO3001 (1) PCR Plate Platform, for PCR Plate, w285 × d285mm
DH.WSO504100 (2) Universal Platform, for Flask Holder, w230 × d230mm
DH.WIS600100 (2) STS Wire Spring Flask Holder, "FHS100", for 100ml Flask
DH.WIS600250 "FHS250", for 250ml Flask
DH.WIS600500 "FHS500", for 500ml Flask
DH.WIS601000 "FHS1000", for 1000ml Flask

Spec.	Model	Shk-300
Max. Capacity of Flask Holder	For 50~100ml	9 ea
	For 200~300ml	7 ea
	For 500~1000ml	4 ea

DH.ShkO3003 Spare ; Rubber Mat Platform, Multi-use, w285 × d285mm

Ea. Price, ₩

DAIHAN® Digital Orbital Shaker "SHO", 10~300 rpm, Low Noise & Long Life Cycle, with Certi. & Traceability
 With Programmable Digital Feedback Control, without Platforms, **디지털 레코드형 셰이커, 저소음 및 긴 수명, 부드러운 시동 동작 및 속도조절**



Figure ; Orbital Shaker "SHO" + (2) Rubber Mat Platform(Option)

- Made in Korea
- CE Certified
- PL(Product Liability) Insurance
- with Certificate & Traceability : Controlled by Serial Number, Certificate, Delivery-information, and Traceable Data Base System
- Ideal for Culturing Cells to Hybridization, Staining and Destaining Gels, and Combinatorial Chemistry
- Patented Jog-Shuttle Control System
 - * Optimal Platform Rotation for Intensive Mixing
 - * Brushless DC Motor(Low Noise & Long Life Cycle)
 - * High Precision Digital Rotation Speed Control
 - * Programmable Operation Mode Supported
 - * Digital LCD with Back-Light Function
 - * Smooth Start and Change of Shaking Speed for Stable Running
 - * Storage Function(Program, RPM, Timer), Alarm(Error Status and Timer-end) & Overload Protection
 - * Locking Mode Supported for Experimental Safety (Input to Jog-Shuttle can be Disabled)

Specifications & Ordering information

Spec.	Model	A. "SHO-1D" Plate Size 230×230 mm	B. "SHO-2D" Plate Size 350×350 mm
Shaking Motion	Orbital Motion		
Speed Range	10 ~ 300 rpm		
Max. Load	8 kg		10 kg
Amplitude of Rotation (mm)	8 mm		15 mm
Motor	Brushless DC Motor		
Permissible Ambient Temp.	Ambient +5 ~ 50 °C		
Permissible Relative Moisture	85%		
Timer & Alarm	99hr 59min (with Continuous run.), Error status & Timer-end		
Display	Digital LCD with Back-Light Function		
Controller	Programmable Digital Feedback Controller with Jog-Shuttle Switch(Turn+Push)		
Program Function	10 Steps, 6 Programs		
Safety Circuit	Overload Protector for Motor		
Dimension (w×d×h) (mm)	260×330×150		400×480×160
Net Weight	14 kg		20 kg
Packing Size (w×d×h) (mm)	450×350×250		580×500×250
& Gross Weight	18 kg		23 kg
Power Consumption	40 W		
Electrical Reqts.	Free Voltage (1 Phase, AC 80V~240V, 50/60Hz)		

Cat. No.	230V	DH.WSO04010	DH.WSO04012
	120V	DH.WSO05010	DH.WSO05012

Price, Each. ₩

* Other Specifications are available upon Customer's Request.

※ 운임 약 ₩ 9,000 별도!

<Optional Accessory>



(1) Universal Perforated Platform & Flask Holder

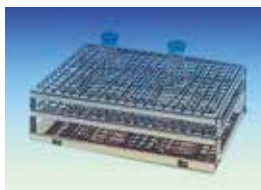

(3) Universal Spring Rack "SP140" / "SP240"



(4) Platform for Flasks "SP120" / "SP220"

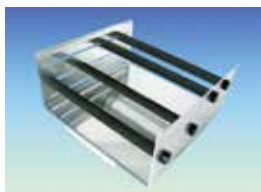

(5) Platform for Separatory Funnels "SP130" / "SP230"

Optional Platform/Flask Holder/Spring Rack

- DH.WSO504100 (1) Universal Platform, "SP100", for "SHO-1D", 230×230mm
- DH.WSO504200 "SP200", for "SHO-2D", 350×350mm
- DH.WIS600100 (1) STS Wire Spring Flask Holder, "FHS100", for 100ml Flask
- DH.WIS600250 "FHS250", for 250ml Flask
- DH.WIS600500 "FHS500", for 500ml Flask
- DH.WIS601000 "FHS1000", for 1000ml Flask

Spec.	Model	SHO-1D	SHO-2D
Max. Capacity of Flask Holder	For 50~100ml	9 ea	20 ea
	For 200~300ml	7 ea	16 ea
	For 500~1000ml	4 ea	9 ea

- DH.WSO504110 (2) Rubber Mat Platform, "SP110", for "SHO-1D", 270×270mm
- DH.WSO504210 "SP210", for "SHO-2D", 370×370mm
- DH.WSO504140 (3) Uni. Spring Rack, "SP140", for "SHO-1D", 270×270×h100mm
- DH.WSO504240 "SP240", for "SHO-2D", 370×370×h100mm
- DH.WSO504120 (4) Platform for Flasks, "SP120", for "SHO-1D", 350×230×h153mm
- DH.WSO504220 "SP220", for "SHO-2D", 350×350×h153mm
- DH.WSO504130 (5) Platform for Sep. Funnels, SP130, for SHO-1D, 350×235×h174mm
- DH.WSO504230 SP230, for SHO-2D, 351×355×h174mm

Ea. Price, ₩

DAIHAN® Premium Digital Orbital & Reciprocating Shaker “MaXshake™”, Powerful Compact Design, 10~300 rpm With Programmable func., Large LCD Display, Quiet & Low-vibration, Available Rubber Mat-/Universal Platform(Optional), without Platform 디지털 궤도형 & 왕복형 셰이커, Small Gaint Power, 저소음/저진동 긴 수명, 부드러운 시동 동작 및 속도 조절



Figure ; Orbital Shaker “MaXshake™ OB2” + (2) Rubber Mat Platform(Optional)



Figure ; Orbital Shaker “MaXshake™ RP2” + (1) Universal Platform & Flask Holder(Optional)

- Made in Korea
- PL (Product Liability) Insurance
- with Certificate & Traceability : Controlled by Serial Number, Certificate, Delivery-information, and Traceable Data Base System
- Ideal for Culturing Cells to Hybridization, Staining and Destaining Gels, Chemistry
- Patented Jog-Shuttle Control System * Variable Accessories are Available (Optional)
- * Hybridization, Washing Blots, Culturing Microbes
- * Compact Design Easily Fits in Incubators and on the Laboratory Bench.
- * Soft Start and Noise-free Operation. * Digital Speed Control easily adjusts from 10 to 300 rpm
- * Built-in Digital Timer. Use in Continuous Shaking or Timer Mode up to 99 hr 59 min.
- * Gentle Speed up and Slow down by PID Speed Control. Slow Start Motion decreases Risk of Spills.
- * Large LCD for Speed and Time Adjustment, makes it possible to read the Speed, Timer Function and Operating Mode.
- * Low Vibration, Low Noise * Clearly laid out Control Panel for easy Operation.
- * Speed Regulation by Microprocessor. * Excellently Applicable for Continuous Operation.
- * Constant Speed Independent Ofload. * Comprehensive Range of Accessories.
- * Audible Buzzer Alarms on Time Expiration and when an Error Occurs.
- * Over-speed Detection and Protection. * Automatic Recovery from Power Break.
- * Brushless Motor Provides Maintenance Free Operation.

Specifications & Ordering information

Spec.	Model	A. “MaXshake™ OB2” Orbital Motion	B. “MaXshake™ RP2” Reciprocating Motion
Shaking Platform Size		255×255 mm	
Shaking Motion		Orbital Motion	Reciprocating Motion
Speed Range & Max. Load		10 ~ 300 rpm, 10kg	
Amplitude of Rotation (mm)		10 mm	
Motor		Brushless DC Motor	
Permissible Temp. & Moisture		Ambient +5 ~ 50℃, 80%	
Timer & Alarm		99hr 59min (with Continuous run.), Error status & Timer-end	
Display		Large Size Digital LCD with Back-Light Function	
Controller		Digital Fuzzy Controller with Touch Button, Jog-dial	
Program Function		10 Steps, 6 Programs	
Platform		Universal Platform for various Shapes & Size of Flask	
Dimension & Weight		376×375×h138 mm(Base Platform : 255×255 mm), 13kg	
Packing Dimension & Weight		345×420×h205 mm, 13.5kg	
Safety Circuit		Overload Protector for Motor	
Power Consumption		45 W	
Electrical Reqts.		1 Phase, AC 120V, 60Hz or AC 230V, 50 / 60Hz	
Cat. No.	230V	DH.WSO00300	DH.WSR00300
	120V	DH.WSO00301	DH.WSR00301
Price, Each. ₩			

* Other Specifications are available upon Customer's Request.

※ 운임 약 ₩ 9,000 별도!

<Optional Accessory>



(1) Universal Perforated Platform & Flask Holder

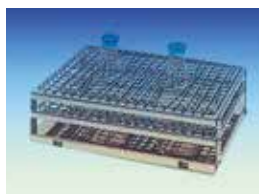

(3) Universal Spring Rack



(4) Platform for Flasks

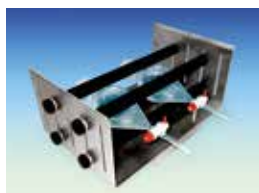

(5) Platform for Separatory Funnels

Optional Platform/Flask Holder/Spring Rack

- DH.WSO604100 (1) Universal Platform, w251×d251mm
- DH.WSO604200 (1) , w346×d346mm
- DH.WIS600100 (1) STS Wire Spring Flask Holder, “FHS100”, for 100ml Flask
- DH.WIS600250 , “FHS250”, for 250ml Flask
- DH.WIS600500 , “FHS500”, for 500ml Flask
- DH.WIS601000 , “FHS1000”, for 1000ml Flask

Spec.	Model	251×251mm	346×346mm
		Universal Platform	Universal Platform
Max. Capacity of Flask Holder	For 100ml	9 ea	20 ea
	For 250ml	7 ea	15 ea
	For 500ml	5 ea	9 ea
	For 1000ml	4 ea	6 ea

- DH.WSO604110 (2) Rubber Mat Platform, w295×d295mm
- DH.WSO604210 (2) , w370×d370mm
- DH.WSO604140 (3) Universal Spring Rack, w295×d295×h100mm
- DH.WSO604240 (3) , w370×d370×h100mm
- DH.WSO604130 (4) Platform for Round Flask, w350×d260×h153mm
- DH.WSO604230 (5) Platform for Separatory Funnels, w350×d260×h153mm

Ea. Price, ₩

DAIHAN® Digital Reciprocating Shaker "SHR", 10~300 rpm, Low Noise & Long Life Cycle, with Certi. & Traceability
 With Programmable Digital Feedback Control, without Platforms, 디지털 양복형 셰이커, 저소음 및 긴 수명, 부드러운 시동 동작 및 속도 조절



- Made in Korea
- CE Certified
- PL(Product Liability) Insurance
- with Certificate & Traceability : Controlled by Serial Number, Certificate, Delivery-information, and Traceable Data Base System
- Ideal for Culturing Cells to Hybridization, Staining and Destaining Gels, and Combinatorial Chemistry
- Patented Jog-Shuttle Control System
- * Optimal Platform Rotation for Intensive Mixing
- * Brushless DC Motor(Low Noise & Long Life Cycle)
- * High Precision Digital Rotation Speed Control
- * Programmable Operation Mode Supported
- * Digital LCD with Back-Light Function
- * Smooth Start and Change of Shaking Speed for Stable Running
- * Storage Function(Program, RPM, Timer), Alarm(Error Status and Timer-end) & Overload Protection
- * Locking Mode Supported for Experimental Safety (Input to Jog-Shuttle can be Disabled)

Specifications & Ordering information

Spec.	Model	A. "SHR-1D" Plate Size 230 × 230 mm	B. "SHR-2D" Plate Size 350 × 350 mm
Shaking Motion		Reciprocating	
Speed Range		10 ~ 300 rpm	
Max. Load		8 kg	10 kg
Amplitude of Rotation (mm)		8 mm	15 mm
Motor		Brushless DC Motor	
Permissible Ambient Temperature		Ambient +5 ~ 50 °C	
Permissible Relative Moisture		85%	
Timer & Alarm		99hr 59min (with Continuous run.), Error status & Timer-end	
Display		Digital LCD with Back-Light Function	
Controller		Programmable Digital Feedback Controller with Jog-Shuttle Switch(Turn+Push)	
Program Function		10 Steps, 6 Programs	
Safety Circuit		Overload Protector for Motor	
Dimension (w × d × h) (mm)		260 × 330 × 150	400 × 480 × 160
Net Weight		14 kg	20 kg
Packing Size (w × d × h) (mm)		450 × 350 × 250	580 × 500 × 250
& Gross Weight		18 kg	23 kg
Power Consumption		40 W	
Electrical Reqt.s.		Free Voltage (1 Phase, AC 80V~240V, 50/60Hz)	
Cat. No.	230V	DH.WSR04020	DH.WSR04022
	120V	DH.WSR05020	DH.WSR05022
Price, Each. ₩			

* Other Specifications are available upon Customer's Request. ※ 운임 약 ₩ 9,000 별도!

Optional Platform/Flask Holder/Spring Rack

- DH.WSO504100 (1) Universal Platform, "SP100", for "SHR-1D", 230 × 230mm
- DH.WSO504200 "SP200", for "SHR-2D", 350 × 350mm
- DH.WIS600100 (1) STS Wire Spring Flask Holder, "FHS100", for 100ml Flask
- DH.WIS600250 "FHS250", for 250ml Flask
- DH.WIS600500 "FHS500", for 500ml Flask
- DH.WIS601000 "FHS1000", for 1000ml Flask

Spec.	Model	SHR-1D	SHR-2D
Max. Capacity of Flask Holder	For 50~100ml	9 ea	20 ea
	For 200~300ml	7 ea	16 ea
	For 500~1000ml	4 ea	9 ea

- DH.WSO504110 (2) Rubber Mat Platform, "SP110", for "SHR-1D", 270 × 270mm
- DH.WSO504210 "SP210", for "SHR-2D", 370 × 370mm
- DH.WSO504140 (3) Uni. Spring Rack, "SP140", for "SHR-1D", 270 × 270 × h100mm
- DH.WSO504240 "SP240", for "SHR-2D", 370 × 370 × h100mm
- DH.WSO504120 (4) Platform for Flasks, "SP120", for "SHR-1D", 350 × 230 × h153mm
- DH.WSO504220 "SP220", for "SHR-2D", 350 × 350 × h153mm
- DH.WSO504130 (5) Platform for Sep. Funnels, SP130, for SHR-1D, 350 × 235 × h174mm
- DH.WSO504230 SP230, for SHR-2D, 351 × 355 × h174mm

Ea. Price, ₩

<Optional Accessory>



(1) Universal Perforated Platform & Flask Holder

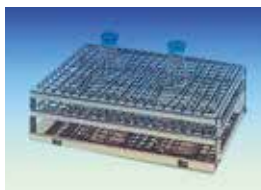

(3) Universal Spring Rack "SP140" / "SP240"



(4) Platform for Flasks "SP120" / "SP220"

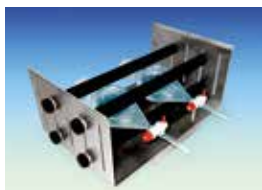
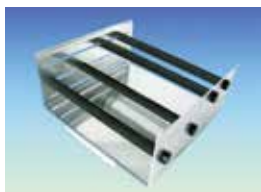

(5) Platform for Separatory Funnels "SP130" / "SP230"

Articles	Cat. No	Description
----------	---------	-------------

DAIHAN® Programmable Digital Rocker “RK”, Digital Feedback Control, 5~50 rpm, with Certi. & Traceability
 With 290×200mm or 300×300mm Platform, Smooth Start & Wave Motion, Tilt Angle ±6°/±9°

디지털 락커, 디지털 피드백 컨트롤 시스템, 부드러운 시동 동작 및 속도 조절



(1) 290×200 mm Rocker “RK-1D” with Included Platform

- Made in Korea
- CE Certified
- with Certificate & Traceability : Controlled by Serial Number, Certificate, Delivery-information, and Traceable Data Base System
- High Precision Digital Speed Control : 1rpm
- Patented Jog-Shuttle Control System
- PL(Product Liability) Insurance
- * Gel Staining, Destaining, Blotting
- * Cell Culture, Hybridization, Washing
- * High Precision Digital Speed Control : 1rpm
- * Programmable Operation Mode Supported : 10 Steps and 6 Programs
- * Digital Timer : Max. 99hr 59min
- * Digital LCD with Back-Light Function for Timer, RPM and Power Bar-Graph
- * Smooth Start and Change of Rocking Speed
- * Overload Protection Function for Motor
- * Storage Function for Set Values : RPM and Timer
- * Alarm Function : Error Status and Timer-end
- * Stainless-steel Platform Comes with Gray Nonslip Rubber Pad
- * Stackable Platform with Pad to Double Mixing Area (Optional)
- * Locking Mode supported for Experimental Safety (Input to Jog-Shuttle can be Disabled)

Specifications & Ordering information



(2) 300×300 mm Rocker “RK-2D” with Second Platform(Optional)

Spec.		Model	(1) “RK-1D” Platform Size 290×200 mm	(2) “RK-2D” Platform Size 300×300 mm
Dimensions (w×d×h)	Platform (mm)		290×200	300×300
	Overall (mm)		290×240×150	300×330×150
Speed Range (rpm)			5 ~ 50	
Angle (degree)			±6 or ±9 (±9 as Factory Default)	
Motor			14W Geared DC Motor	
Program Function			10 Steps, 6 Programs	
Timer & Alarm			99hr 59min (with Continuous run.), Error status & Timer-end	
Display			Digital LCD with Back-Light Function	
Controller			Programmable Digital Feedback Controller with Jog-Shuttle Switch(Turn+Push)	
Safety Circuit			Overload Protector for motor	
Platform (Included)			290×200mm Platform	300×300mm Platform
Others			CE Certified, PL(Product Liability) Insurance Smooth Start and Change of the Stirring Speed for Stable Running Storage Function (RPM, Timer) Locking Mode (Jog-Shuttle Input Disabled) Alarm (Error Status and Timer-end)	
Packing Dimension (w×d×h) (mm)			450×350×250	
Gross Weight			7 kg	8 kg
Power Consumption			35 W	
Electrical Reqts.			Free Voltage (1 Phase, AC 80V~240V, 50/60Hz)	
Cat. No.	230V		DH.WRK01010	DH.WRK01020
	120V		DH.WRK02010	DH.WRK02020
Price, Each. ₩				

* Other Specifications are available upon Customer's Request.

Optional Second Platform

- DH.WRK05011 Second Platform, “RK5011”, for “RK-1D”, w290×d200, with 4 Pillars(L120mm)
- DH.WRK05021 Second Platform, “RK5021”, for “RK-2D”, w300×d300, with 4 Pillars(L120mm)

Ea. Price, ₩

DAIHAN® Programmable Digital Rotator “RT-10”, 0~90° Mixing Angle, 5~60rpm, with Certi. & Traceability
With Digital Feedback Control, Adjustable Speed & Angle of Rotation, Continuous or Timed Operation
디지털 로테이터, 디지털 피드백 컨트롤 시스템, 회전각 및 회전속도 조절 가능



Programmable Digital Rotator “RT-10”
with Optional Disk “WRT120” for 32 x 1.5ml Tube

- **Made in Korea** ■ **CE Certified**
- **with Certificate & Traceability : Controlled by Serial Number, Certificate, Delivery-information, and Traceable Data Base System**
- **Adjustable Speed and Angle of Rotation : 0 to 90°**
- **Patented Jog-Shuttle Control System**
- **PL (Product Liability) Insurance**
- * General Mixing, Diffusing, Dialyzing and Hybridization, Aerating Culture
- * Keeping Biological Samples in Suspension
- * Adjustable Speed and Angle of Rotation : 0 to 90°
- * Digital Feedback Control: Steady and Constant Rotating
- * Continuous or Timed Operation
- * Digital LCD with Back-Light Function
- * Programmable Operation Mode Supported : 10 Steps and 6 Programs
- * Overload Protection for motor
- * Smooth Start and Change of Stirring Speed
- * Storage Function for Set values of RPM and Time
- * Locking Mode Supported for Experimental Safety (Input to Jog-Shuttle can be Disabled)
- * Durable Construction for Long-Term Operation
- * 5 Different Disks and 3 Roller Drums(Optional)
- * Disk for 250ml Flask is available

Specifications & Ordering information

Spec.	Model	“RT-10”
Speed range		5~ 60 rpm
Angle range		0° ~ 90°
Motor		35W
Program Function		10 Steps, 6 Programs
Timer & Alarm		99hr 59min (with Continuous run.), Error status & Timer-end
Display		Digital LCD with Back-Light Function
Controller		Programmable Digital Feedback Controller with Jog-Shuttle
Temp. Resistance		Lower than 65℃ (Dry Air)
Safety Circuit		Overload Protector for motor
Dimensions (w × d × h) (mm)		200 × 250 × h260 mm
Weight		6 kg
Others		CE Certified, PL(Product Liability) Insurance Storage Function (RPM, Timer) Locking Mode (Jog-Shuttle Input Disabled) User Self-compensation Function, Alarm (Error Status and Timer-end)
Packing Size (w × d × h) (mm) & Gross Weight		370 × 240 × h430 mm 8.5 kg
Power Consumption		40 W
Electrical Reqt.s.		1 Phase, AC 120V, 60Hz or AC 230V, 50 / 60Hz
Cat. No.	230V	DH.WRT00010
	120V	DH.WRT00020
Price, Each. ₩		

* Other Specifications are available upon Customer's Request.



Optional Disk & Roller Drum

- DH.WRT00100 (1) Disk, “WRT100”, for 50ml conical tube × 8ea
- DH.WRT00110 (2) , “WRT110”, for 15ml conical tube × 16ea
- DH.WRT00120 (3) , “WRT120”, for 1.5ml conical/centrifuge Tube × 32ea
- DH.WRT00130 (4) , “WRT130”, for 1.5ml conical/centrifuge Tube × 60ea
- DH.WRT00140 (5) , “WRT140”, 250ml Flask-capacity × 4ea

Ea. Price, ₩

Spare Knob & Post

- DH.WRT00300 (6) 4 × knobs & 4 × Post, “WRT300”, for Installing Disk

Ea. Price, ₩

Sterilizer

Autoclave, Bench-top <i>New</i>	P.214~215
, Front Door <i>New</i>	P.216
, Vertical	P.212~213
Dry Heat Sterilizer <i>New</i>	P.217
Plasma Sterilizer <i>New</i>	P.218~219
Accessory	P.213



Class-II Medical Device

Autoclave, Bench-top, 40 Lit
"MaXterile™ BT40"



Class-II Medical Device

Autoclave, Front Door, 90 Lit
"MaXterile™ FL90"



Autoclave, Vertical, 100 Lit
"MaXterile™ 100"



Class-II Medical Device

Low Temp Plasma Sterilizer, 60 Lit
"MaXterile™ PS60"

DAIHAN® Digital Fuzzy-control Autoclave “MaXterile™”, Standard-/Recorder-type, 47 · 60 · 80 · 100 Lit
 With Electronic Door Lock Sys, Lever-type Sliding Door, Steam Condensing, Solid-/Liquid-Modes, Max.2 kgf/cm², up to 132 °C
 (1) PED Certified-model(φ 3.0mm Thick-Tank), (2) Non-PED-model(φ 2.0mm Thick-Tank), 전자동 고압 멸균기, 전자식 도어 잠금 시스템



Standard-type, “MaXterile™ 80”
 (1) With PED Certi. 3mm Thick-Tank
 (2) Without PED Certi. 2mm Thick-Tank



Built in Recorder-type, “MaXterile™ 80R”
 (1) With PED Certi. 3mm Thick-Tank
 (2) Without PED Certi. 2mm Thick-Tank

- Made in Korea ■ CE and PED Certified ■ PL (Product Liability) Insurance
- with Certificate & Traceability : Controlled by Serial Number, Certificate, Delivery-information, and Traceable Data Base System
- Patented Special Steam Condensing Mechanism, Lever-type Sliding Door
- Built in DAIHAN® New Generation Controller : Patented Jog-Dial Control System
- Electronic Door Lock Sensing System for User Safety.
- Door Open Button Automatically Lock Over 80°C for User Safety
- Built in Recorder model (only MaXterile 47R/60R/80R/100R models) : Print Sterilization Cycle Data for Validation and Analyze Sterilization (Temperature, Pressure, Time, Error Status, etc.)

- * Ideal for Biotechnology, Clinical, Environmental, Medical and Food Industry.
- * Innovative Easy-to-Use Digital Fuzzy Controller. * Included 2 × Wire Baskets
- * Digital Timer Function - 'Delay Time' and 'Operation Time' can be Controlled.
- * Solid / Liquid Mode can be chosen by a customer considering a Sample Phase.
- * Water Low Level Detection * Automatic Over Pressure Release Valve ensures User Safety.
- * Sterilization Error Indication : Error Alarm and Massage in case of Power Failure and Temperature Error

Specifications & Ordering information

Standard-type Models	“MaXterile 47” Max. 47Lit	“MaXterile 60” Max. 60Lit	“MaXterile 80” Max. 80Lit	“MaXterile 100” Max. 100Lit
	Standard-type			
Built in Recorder-type Models	“MaXterile 47R”	“MaXterile 60R”	“MaXterile 80R”	“MaXterile 100R”
	Recorder-type : Built in Recording Printer, Sterilization Cycle Data (Date, Temperature, Pressure, Time, Error Status, etc.)			
Capacity	47 Lit	60 Lit	80 Lit	100 Lit
Temp. Range & Accuracy	Room Temp +5°C to 132°C, ±0.5°C at 121°C			
Pressure & Gauge	1.2 kgf/cm ² at 121°C / 2.0 kgf/cm ² at 132°C, 0 ~ 3 kgf/cm ²			
Sterilization mode	Solid- or Liquid-mode			
Heating Power/Consumption	2 kW	3 kW	2 kW×2	2 kW×2
Timer & Alarm	60 min, Error status & Timer-end			
Display	Digital LCD with Back-Light Function			
Controller	Digital Fuzzy-Control System (Fully Automatic)			
Door & Closing System	Lever-type Sliding Door / Safety Electronic Door Closing System			
Safety Circuit	Over-Temp./-Pressure/-Current protection, Sensor Error Detection			
Printer	Thermal type printer, Record Paper Roll: w58 × φ40 mm			
Material	Stainless-steel (# 304)-Pressure Vessel, Powder Coated steel-External			
Basket	2ea of Stainless-steel Wire Baskets are Included			
Basket Dimension (mm)	φ 270 × h240	φ 320 × h240	φ 370 × h240	φ 420 × h240
Dimension	Inner (mm) φ 300 × h670 φ 350 × h650 φ 400 × h650 φ 450 × h630			
(w × d × h)	Outer (mm) 700 × 470 × 1080 700 × 470 × 1080 810 × 580 × 1140 810 × 580 × 1140			
Packing Size (mm)	840 × 610 × h1,252 mm 950 × 730 × h1,352 mm			
Gross Weight (kg)	117 kg	120 kg	170 kg	170 kg
Electric Reqts.	1Phase - AC 120V, 60Hz or - AC 230V, 50/60Hz		1 Phase - AC 120V, 60Hz or - AC 230V, 50/60Hz 3 Phase with Terminal Block	

(1) With PED(Pressure Equipment Directive) Certification, φ 3.0mm Thickness Tank

Standard-type Cat. No.	230V	DH.WAC05047P	DH.WAC05060P	DH.WAC05080P	DH.WAC05100P
	120V	DH.WAC06047P	DH.WAC06060P	DH.WAC06080P	DH.WAC06100P
	3Phase	-	-	DH.WAC07080P	DH.WAC07100P
Price, Each. ₩					
Built in Recorder-type Cat. No.	230V	DH.WACR2047P	DH.WACR2060P	DH.WACR2080P	DH.WACR2100P
	120V	DH.WACR1047P <td>DH.WACR1060P <td>DH.WACR1080P <td>DH.WACR1100P</td> </td></td>	DH.WACR1060P <td>DH.WACR1080P <td>DH.WACR1100P</td> </td>	DH.WACR1080P <td>DH.WACR1100P</td>	DH.WACR1100P
	3Phase	-	-	DH.WACR3080P	DH.WACR3100P
Price, Each. ₩					

(2) Without PED(Pressure Equipment Directive) Certification, φ 2.0mm Thickness Tank

Standard-type Cat. No.	230V	DH.WAC05047	DH.WAC05060	DH.WAC05080	DH.WAC05100
	120V	DH.WAC06047	DH.WAC06060	DH.WAC06080	DH.WAC06100
	3Phase	-	-	DH.WAC07080	DH.WAC07100
Price, Each. ₩					
Built in Recorder-type Cat. No.	230V	DH.WACR2047	DH.WACR2060	DH.WACR2080	DH.WACR2100
	120V	DH.WACR1047	DH.WACR1060	DH.WACR1080	DH.WACR1100
	3Phase	-	-	DH.WACR3080	DH.WACR3100
Price, Each. ₩					

* Other Specifications are available upon Customer's Request.

※ 운임 약 ₩ 30,000 별도!

<Continued On Next Page>

Articles

Cat. No

Description

<Continued From...DAIHAN® Digital Fuzzy-control Autoclave, "MaXterile™" Standard-/Recorder-type>

(3) Wire Basket Stainless-steel
(Included)

Side



Bottom

(4) Perforated Bottom Basket, Stainless-steel
(Optional)

(3) Spare Wire Basket, Stainless-steel & Thermal Paper for Recorder

Articles	Description	Ea. Price, ₩
SL.Bas7011	Wire Basket, $\phi 270 \times h240$ mm, "Bas7011", for 47 Lit, "MaXterile 47", "MaXterile 47R"	
SL.Bas7012	Wire Basket, $\phi 320 \times h240$ mm, "Bas7012", for 60 Lit, "MaXterile 60", "MaXterile 60R"	
SL.Bas7013	Wire Basket, $\phi 370 \times h240$ mm, "Bas7013", for 80 Lit, "MaXterile 80", "MaXterile 80R"	
SL.Bas7014	Wire Basket, $\phi 420 \times h240$ mm, "Bas7014", for 100 Lit, "MaXterile 100", "MaXterile 100R"	
DH.WACR5004	Thermal Paper, 4 \times Paper Roll for "MaXterile R"	

(4) Optional Perforated Bottom Basket, Stainless-steel

Articles	Description	Ea. Price, ₩
DH.WAC20047	Perforated Basket, $\phi 270 \times h250$ mm, "WAC20047", for 47 Lit "MaXterile 47", "MaXterile 47R"	
DH.WAC20060	Perforated Basket, $\phi 320 \times h250$ mm, "WAC20060", for 60 Lit "MaXterile 60", "MaXterile 60R"	
DH.WAC20080	Perforated Basket, $\phi 370 \times h250$ mm, "WAC20080", for 80 Lit "MaXterile 80", "MaXterile 80R"	
DH.WAC20100	Perforated Basket, $\phi 420 \times h250$ mm, "WAC20100", for 100 Lit "MaXterile 100", "MaXterile 100R"	

Autoclave with Validation (IQ, OQ) Service

Articles	Description	Ea. Price, ₩
DH.WAC30047	Validation Service(IQ, OQ), with "MaXterile 47", "ACV47"	
DH.WAC30060	, with "MaXterile 60", "ACV60"	
DH.WAC30080	, with "MaXterile 80", "ACV80"	
DH.WAC30100	, with "MaXterile 100", "ACV100"	
DH.WACR0047	Validation Service(IQ, OQ), with "MaXterile 47R", "ACRV47"	
DH.WACR0060	, with "MaXterile 60R", "ACRV60"	
DH.WACR0080	, with "MaXterile 80R", "ACRV80"	
DH.WACR0100	, with "MaXterile 100R", "ACRV100"	

Sterilizer, Accessory

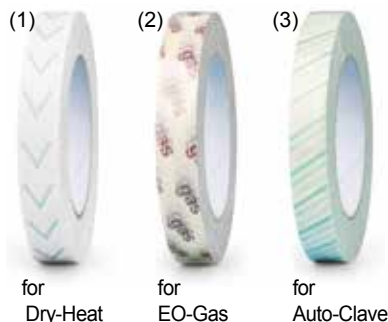
for
Dry-Heatfor
EO-Gasfor
Auto-ClaveSterilization Indicator Tape, w19mm \times L50m/Roll

For Dry-Heat, EO-Gas, and Steam Sterile/Autoclaving, 멸균 감지 테이프

* Changing Color after Expose to Sterilization Process(Dry-Heat, EO-gas, Steam Sterile)

(1) For Dry-Heat Sterile * Supplied by Kartell® in Italy

KA.1051 Dry-Heat Sterile Indicator, w19mm \times L50m-Roll, White \rightarrow Brown

Ea. Price, ₩
1roll

(2) For EO-Gas Sterile * Supplied by Heinz Herenz® in Germany

HH.1080551 EO-Gas Sterile Indicator, w19mm \times L50m-Roll, Red \rightarrow Green

Ea. Price, ₩
1roll

(3) For Steam Sterile/Autoclaving * Supplied by Heinz Herenz® in Germany

HH.1080550 Autoclave/Steam Sterile Indicator, w19mm \times L50m-Roll, Green \rightarrow Brown

Ea. Price, ₩
1roll

Dry-Heat Sterilizer Indicator Label on Sheet, 160°C/3h, 180°C/30min, Pink \Rightarrow Brown

For Indicating Sterilizer, Color-Changing : from Pink to Brown, 가열 멸균 감지 라벨

■ Supplied by LMS® in Japan

* Change of Color : Pink \blacktriangleright Brown

* Changing Time : 30 minutes at 180°C, 3 Hours at 160°C

AS2.6419.01 Heat-Sterile Label "D-L", w19 \times L32mm

Cs. Price, ₩
500ea

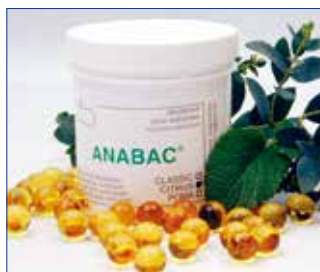

Anabac® Deodorant "Classic" for Autoclaving, 100 Tablets

Ideal for deodorization, Deodorant Capacity : max 200Lit. per One-tablet, 사과향 오토클레이브용 탈취제

■ Supplied by LMS® in Japan

* French Bracing Fragrance

* 100 Tablets / Packed in PP/Paper Container

* Deodorant Volume : Max 200Lit per 1-Tablet

AS2.6361.02 Deodorant for Autoclave, Apple, 100 Tablets / a Container

Pk. Price, ₩
100ea

DAIHAN® 21.5 Lit Programmable Bench-top Autoclave “MaXterile™ B”, 121~134 °C, Pending Class II Medical Device With Pre- & Post-Vacuum Drying, Class-B Sterilization Cycle, Safety Door Lock System, HEPA Filter, 2 Perforated STS Tray **NEW** Round Chamber, Max 2.40 bar, 원형챔버 벤치탑 고압 멸균기, 전자식 도어 잠금 시스템



21.5 Lit Bench-top Autoclave “MaXterile™ B”

- Made in Korea
- PL(Product Liability) Insurance
- with Certificate & Traceability : Controlled by Serial Number, Certificate, Delivery-information, and Traceable Data Base System.
- Ideal for Dental Clinical, Medical, Biotechnology, etc.
- Pre-vacuum Air Removal & Post Vacuum Drying for Perfect Sterilizing.
- Safety Door Lock System for User Safety.
- Class-B Sterilization Cycle by EN13060 Standard :
 - Hollow Load Test in compliance with EN13060 & EN 867-5 Standard.
 - Suitable to SAL=10⁻⁶CFU, EN556-1 Certificate Sterilization Standard.
- * Air Filtration System : HEPA Filter of efficiency up to 99.999% & 0.3 micron size.
- * Special Steam Condensing Mechanism for User Safety
- * Manual Top Water Filling(Built in Water Level Sensor). * Optional Built-in Thermal Printer
- * Efficient Space Saving Compact Size Body and Round Inner Chamber.
- * Programmable Function : Provide 7-Program Sterilizing Operation Cycles (Pre-set 5 Programs & Customizable 2 Programs)
- * Intuitive User Interface : LCD & Capacitive Touch Button Controller for User Convenience.
- * High-performance Microprocessor Controller
- * Class-B Sterilizing Cycle Process by EN13060 Standard :
 - Pre-vacuum→ Water Filling→ Heating→ Sterilizing→ Exhaust→ Post-vacuum Drying→ End of Cycle



Round Inner Chamber



Sliding Perforated Shelf

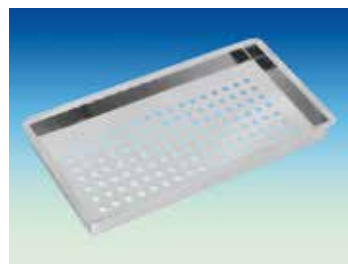

(1) STS Perforated Tray



(2) Thermal Printer

Specifications & Ordering information

Spec.	Model	“MaXterile™ B21”
Sterilizing Cycle-type		Class-B Cycle by EN13060 Standard
Capacity		21.5 Lit
Temp. Range		Room Temp +5 °C to 134 °C
Pressure & Gauge		Min -1.00bar, Max 2.40 bar, Built-in Digital Pressure Gauge
Timer & Alarm		60 min, Error status & Timer-end
Display		Digital LCD with Back-Light Function
Controller		Digital PID Control System (Fully Automatic), Touch Button UI
Programmable Function		Pre-set 5 Programs & Customizable 2 Programs
Door-type		Manual Double Lever-type Door Lock System
Trays (Included)		2 Stainless-steel Perforated Tray (216×405×h44mm)
Air Filtration System		Built-in HEPA filter, 0.3µm Particle Removal 99.97%
Vacuum Pump		Built-in 11Lit/min Vacuum Pump for Pre-vacuum & Post-vacuum Drying
Air Removal-type		Vacuum & Gravity
Water Filling Tank		4.2Lit, 238 × 117 × h233mm
Safety Circuit		Over-Temp./-Pressure/-Current protection, Sensor Error Detection
Material		Stainless steel-Pressure Vessel, Powder Coated steel-External
Dimension (w×d×h)	Interior	225×425×h225 mm
	Exterior	530×692×h391 mm
Power Consumption		2,300 W
Net Weight		56 kg
Electric Reqts.		1 Phase, AC 120 V, 60 Hz or AC 230 V, 50 / 60 Hz

Cat. No.	230V	DH.WACB0021
	120V	DH.WACB0121
Price, Each. ₩		

* Other Specifications are available upon Customer's Request.

Spare Stainless-steel Perforated Tray

DH.WACB1001	(1) STS Perforated Tray, 216×405×h44mm	Ea. Price, ₩
--------------------	--	---------------------

Optional Thermal Printer

DH.WACP001	(2) Thermal Printer, Built-in type, 76.5×72mm	Ea. Price, ₩
DH.WACR5004	Thermal Paper, 4× Paper Rolls, w58×φ40mm, for Thermal Printer	

Bench-top Autoclave with Validation (IQ, OQ) Service

DH.WACB5021	Validation Service(IQ, OQ), with “MaXterile B21”	Ea. Price, ₩
--------------------	--	---------------------

DAIHAN® 25 & 40Lit Programmable Bench-top Steam Sterilizer “MaXterile™ BT”, 110~135 °C, Class-II Medical Device(NIDS) With Auto-Front Door, Pre- & Post-Vacuum System, Class-B Sterilization, Auto-Microprocessor Control, and Dual Door Lock SQUARE Chamber Autoclave, 2 Perforated STS Tray, HEPA Filter, Max 2.30 bar, 사각챔버 벤치탑 고압 멸균기 **NEW**



NEW

Class-II Medical Device

110~135 °C
0.4 ~ 2.3 bar

2-Year Warranty

25 & 40 Lit Bench-top Steam Sterilizer
“MaXterile™ BT”

MODE	Temperature (°C)	Pressure (bar)	Sterilizing Time (min)	Drying Time (min)
Unwrapped 1	121	1.1	20	30
Unwrapped 2	134	2.1	5	30
Wrapped 1	121	1.1	30	30
Wrapped 2	134	2.1	15	30
Liquid	121	1.1	20	0
Bowie Dick	134	2.1	4	5
User Program	110 - 135	0.4 - 2.3	4 - 30	0 - 60

Program Cycle



Square Inner Chamber



Sliding Perforated Shelf

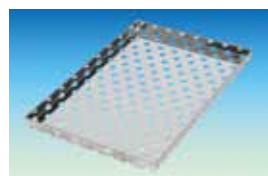

(1) STS Perforated Tray

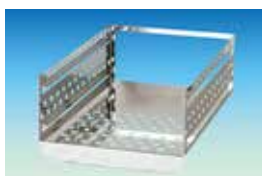

(2) STS Removable Rack



(3) HEPA Filter-kit, 0.3µm



(4) Movable Stand



(5) Thermal Printer

- Made in Korea ■ PL(Product Liability)
- with Certificate & Traceability : Controlled by Serial Number, Certificate, Delivery-information, and Traceable Data Base System.
- Class-B Sterilization Cycle by EN13060-2 Standard : Pre Vacuum Air Removal → Water Filling → Heating → Sterilizing → Ventilation → Post Vacuum Drying → End
- STS Square Chamber for Corrosion Resistance and Maximum Working Space
- * Ideal for Dental Clinical, Medical, Biotechnology, etc.
- * Full Automatic Process Cycle by High-performance Microprocessor Controller
- * Built-in Separate Water Reservoir Supplies Water Automatically
- * Self-diagnostic and Safety System :
 - Display Error Codes and Audible Alarm
 - Over Pressure Release Valve
 - Automatic and Manual Door Lock System
 - Over Temp Protector with Thermostat
- * Intuitive User Interface(LCD) & Indicator of Working(LED Lamp)

Specifications & Ordering information

Spec.	Model	“MaXterile™ BT25”	“MaXterile™ BT40”
Capacity		25 Lit	40 Lit
Water Filling Tank		5 Lit (Reservoir)	
Sterilizing Cycle-type		Class-B Cycle by EN13060-2 Standard	
Temp. Range		110 ~ 135 °C	
Pressure & Gauge		0.4 ~ 2.3 bar, Built-in Analog & Digital Pressure Gauge	
Timer & Alarm		Error Status & Timer-end	
Controller		Microprocessor PID Control System(Fully Automatic) with LCD Monitor	
Programmable Function		Pre-set 6 Programs (Customizable 5- & Fixed Bowie Dick 1- Program)	
Door Lock		Automatic Wheel Inter Locking with One Touch Sliding Handle	
Air Filtration System		Built-in HEPA Filter, 0.3µm Particle Removal 99.97%	
Vacuum Pump		Built-in Vacuum Pump(33LPM, 580mmHg) for Pre-vacuum & Post-vacuum Drying	
Air Removal-type		Vacuum	
Tray (Included)		2 Stainless-steel Perforated Tray	
Safety Circuit		Over-Temp / -Pressure / -Current protection, Sensor Error Detection	
Material		Interior : Stainless-steel 304 Polished, Exterior : Epoxy Powder Coated Steel	
Dimension (w×d×h) & Weight	Interior	270×420×h230 mm	300×480×h300 mm
	Exterior	495×689×h460 mm, 60 kg	527×787×h530 mm, 70 kg
	Packing	580×750×h580 mm, 75 kg	650×820×h740 mm, 85 kg
Power Consumption		2.5 kW	
Electric Reqt.s.		110 V, 60 Hz or 220 V, 50 / 60 Hz, 1 Phase	

Cat. No.	220V	DH.SteB8001	DH.SteB8002
	110V	DH.SteB8011	DH.SteB8012
Price, Each. ₩			

* Other Specifications are available upon Customer's Request.

※ 운임 별도!

Spare Accessory

- DH.SteBA1010 (1) STS Perforated Tray , 255×365×h25 mm , for “MaXterile BT25”
- DH.SteBA1015 , 285×405×h30 mm , for “MaXterile BT40”
- DH.SteBA1011 (2) STS Removable Rack, 260×385×h155mm, for “MaXterile BT25”
- DH.SteBA1016 , 290×425×h185mm, for “MaXterile BT40”
- DH.SteA1015 (3) Replacement HEPA Filter-kit, 0.3µm

Ea. Price, ₩

Optional Accessory

- DH.SteBA1013 STS Wire Tray, 260×370 mm, for “MaXterile BT25”
- DH.SteBA1017 , 273×410 mm, for “MaXterile BT40”
- DH.SteBA1026 (4) Movable Stand with 1 Drawer, 580×700×h850 mm
- DH.SteA1005 (5) Thermal Printer, Paper Roll, “STEA1005”
- DH.SteA1006 Thermal Paper Package, 4 Paper Roll, for “STEA1005”

Ea. Price, ₩

Bench-top Autoclave with Validation (IQ, OQ) Service

- DH.SteB5025 Validation Service(IQ, OQ), with “MaXterile BT25”
- DH.SteB5040 , with “MaXterile BT40”

Ea. Price, ₩

DAIHAN® 90Lit Front Door Steam Sterilizer “MaXterile™ FL90”, 110~135 °C, **Class-II Medical Device(NIDS)** **NEW**
 With Built-in Steam Generator, Water Ejector Vacuum Pump, Thermal Printer, 2 Perforated STS Tray, HEPA Filter
 SQUARE Chamber Autoclave, Pre- & Post-Vacuum Drying, Auto-Door Lock & Alarm System, Max 2.30 bar, **사각챔버/전면문 고압 멸균기**



110~135°C
0.4 ~ 2.3 bar

2-Year Warranty

90Lit Front Door Steam Sterilizer “MaXterile™ FL90”



2-Year Warranty

Vertical Sliding Door & Square Chamber

MODE	Temperature (°C)	Pressure (bar)	Sterilizing Time (min)	Drying Time (min)
Unwrapped 1	121	1.1	20	30
Unwrapped 2	134	2.1	5	30
Wrapped 1	121	1.1	30	30
Wrapped 2	134	2.1	15	30
Liquid	121	1.1	20	0
Bowie Dick	134	2.1	4	5
User Program	110 - 135	0.4 - 2.3	4 - 30	0 - 60

Program Cycle

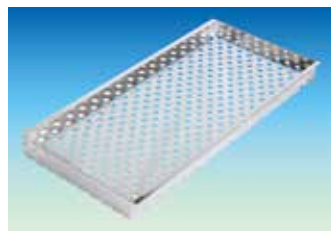

(1) STS Perforated Tray



(2) Thermal Paper Roll

- Made in Korea ■ PL(Product Liability)
- with Certificate & Traceability : Controlled by Serial Number, Certificate, Delivery-information, and Traceable Data Base System.
- Class-B Sterilization Cycle by EN285 Standard :

Pre-vacuum → Steam Generation → Steam Injection → Sterilizing → Exhaust → Post-vacuum Drying → End of Cycle

- * Ideal for Dental Clinical, Medical, Biotechnology, etc.
- * Pre-vacuum Air Removal & Post Vacuum Drying for Perfect Sterilizing
- * Built-in Steam Generator Supplies Water Automatically and Sprays Steam into the Chamber
- * Water Ejector Vacuum Pump : Effective for Fluid Control(1800L/hr)
- * Air Filtration System : 0.3µm HEPA Filter of Efficiency up to 99.97%
- * Automatic Dual Door Locking System for User Safety.
- * Programmable Function : Provides 6-Program & User Customizable 1 Program
- * Intuitive User Interface(LCD) & Indicator of Working(LED Lamp)
- * Self-Diagnostic and Display Error Codes
- * Visual and Audible Alarm System
- * Sturdy and Convenient Locking Wheel helps to Move Easily
- * Built-in Thermal Printer

Specifications & Ordering information

Spec.	Model	“MaXterile™ FL90”
Capacity		90 Lit
Sterilizing Cycle-type		Class-B Cycle by EN-285 Standard
Temp. Range		110~135°C
Pressure & Gauge		0.4 ~ 2.3 bar, Built-in Analog & Digital Pressure Gauge
Timer & Alarm		60 min, Error Status & Timer-end Alarm
Display		Digital LCD with Back-Light Function & LED Lamp (Working Process)
Controller		Microprocessor Digital PID Control System (Full Automatic)
Programmable Function		Pre-set 6 Programs (Customizable 5- & Fixed Bowie Dick 1- Program)
Door-type		Manual Vertical Sliding Door, Automatic Door Locking System
Chamber		Reinforced and Electro Polished Square Chamber with Double Jacket
Tray (Included)		2 Stainless-steel Perforated Tray
Safety Circuit		Over-Temp / -Pressure / -Current protection, Sensor Error Detection
Material		Interior : Stainless-steel 304 Pressure Vessel, Exterior : Stainless-steel
Dimension (w×d×h) & Weight	Interior	338×712×h378 mm
	Exterior	625×990×h1300 mm, 280 kg
	Packing	850×1100×h1400 mm, 295 kg
Power Consumption		6.0 kW
Electric Reqts.		220 V 50 / 60 Hz, 1 Phase
Cat. No.		DH.SteF8001
Price, Each. ₩		

* Other Specifications are available upon Customer's Request.

※ 운임 별도!

Spare Accessory

- DH.SteFA1001 (1) STS Perforated Tray, 323×667×h54 mm for “MaXterile FL90”
- DH.SteA1006 (2) Thermal Paper Package, 4 Paper Roll for Thermal Recorder
- DH.SteA1016 Replacement HEPA Filter-kit

Ea. Price, ₩

Front Loading Sterilizer with Validation (IQ, OQ) Service

- DH.SteF5001 Validation Service(IQ, OQ), with “MaXterile™ FL90”

Ea. Price, ₩

DAIHAN® 32 & 50Lit, Dry Heat Sterilizer “MaXterile™ DH”, Up to 250°C, Pending Class-II Medical Device(NIDS) NEW
 With 3-Side Pre-Heating Zone, Digital PID Control, Jog-Dial & Push Button, and 2 Wire Shelf, **건열 멸균기**



Dry Heat Sterilizer “MaXterile™ DH”

- **Made in Korea**
 - **PL(Product Liability) Insurance**
 - **with Certificate & Traceability : Controlled by Serial Number, Certificate, Delivery-information, and Traceable Data Base System.**
 - **Optimized Air Flow by Forced-air Mechanism**
 - **3-Side Heating Zone : The Best Temp Uniformity & Accuracy by High Performance Heating Mechanism**
- * Ideal for Dental Clinical, Medical, Biotechnology, etc.
 - * Digital PID Control System Implementing Superior Temperature Accuracy
 - * Patented Jog-Dial Control System
 - * Space Saving Compact Size
 - * Efficient Square Inner Chamber
 - * Alarm Function : Error Status and Timer-end

Specifications & Ordering information

Spec.	Model	“MaXterile™ DH-30”	“MaXterile™ DH-50”
Capacity		32 Lit	50 Lit
Heater Power		500 W	650 W
Temp.	Range	Room Temp +5°C to 250°C	
	Fluctuation	± 0.3°C at 100°C, ± 0.5°C at 180°C,	
	Variation	± 1°C at 100°C, ± 2.0°C at 180°C	
	Sensor	PT100	
Temp. Resolution		± 0.1°C	
Circulation		Forced-air Type	
Controller		Digital PID Control by Advanced Microprocessor Jog-Dial with Push Button	
Display		Digital LCD with Back Light	
Timer		99hr 59min (Delay / Continuous Function)	
Material	Internal	Stainless-steel (#304)	
	External	Powder Coated Steel	
	Insulation	Glass Wool	
Shelf (Included)		2 Stainless-steel Wire Shelf Load per Shelf : 16 kg	
Safety Device		Over Temp and Over Current Protector, Sensor Error Detector	
Dimension (w×d×h)	Interior	312×290×h360 mm	370×350×h420 mm
	Exterior	458×477×h624 mm	518×537×h701 mm
	Packing	568×592×h698 mm	628×652×h775 mm
Net Weight		32 kg	40 kg
Shipping Weight		39 kg	53 kg
Power Consumption		550 W	700 W
Electric Reqts.		230 V, 50 / 60 Hz	

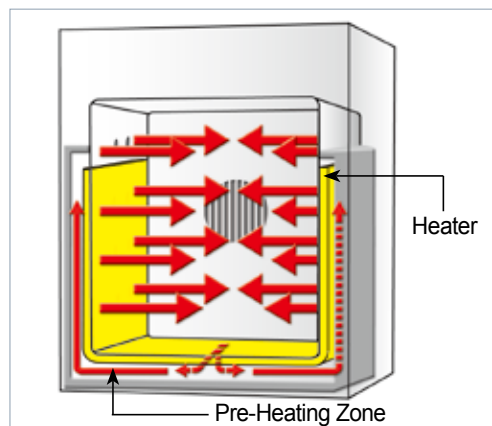

3-Side Heating Zone Forced-air Mechanism

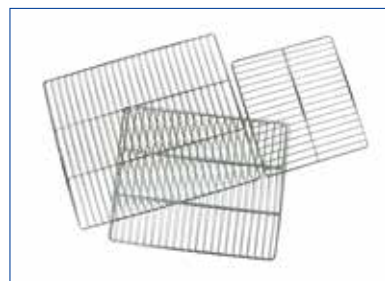

(1) STS Wire Shelf (Included)

Cat. No.	DH.SteD0003	DH.SteD0005
Price, Each. ₩		

* Other Specifications are available upon Customer's Request.

※ **윤임 별도!**

Spare Stainless-steel Wire Shelf

DH.WIG12032 (1) Wire Shelf, 280×260 mm, for 32 Lit, “IGSN032”
DH.WON11050 , 340×310 mm, for 50 Lit, “ONS050”

Ea. Price, ₩

Dry Heat Sterilizer with Validation (IQ, OQ) Service

DH.SteD5003 Validation Service(IQ, OQ), with “MaXterile DH30”
DH.SteD5005 , with “MaXterile DH50”

Ea. Price, ₩

DAIHAN® 56Lit Low Temp Plasma Sterilizer “MaXterile™ PS60”, Max. 60°C, **Class-II Medical Device(NIDS)** **NEW**
 Suitable for Medical Instrument, 50% Hydrogen Peroxide Injection, Microprocessor 7" Touch Screen Controller
 Front Door / SQUARE Chamber, with 2 Perforated STS Tray, **저온 플라즈마 멸균기**



NEW
 Class-II Medical Device
 MAX. 60°C

2-Year Warranty

56Lit Low Temp Plasma Sterilizer “MaXterile™ PS60”



(1) 2 STS Tray

2-Year Warranty

Front Door Open & Perforated Tray (Included)

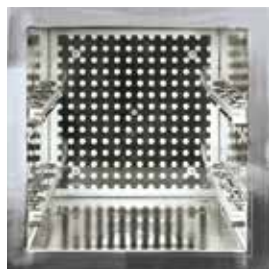

Square Inner Chamber



(2) 50% H₂O₂ Bottle



(3) Air Filter-kit



(4) Movable Stand

- Made in Korea ■ PL(Product Liability)
- with Certificate & Traceability : Controlled by Serial Number, Certificate, Delivery-information, and Traceable Data Base System.
- Speedy Sterilization Time within 30-60min, Economical Cycle Cost
- Environment Friendly : H₂O₂ Decomposes to Oxygen and Vapor Water, Leaving No Residues
- * Ideal for Sterilization of Medical Instruments that are Vulnerable to High Temp, Steam & Pressure such as Surgical Endoscopes, Catheter, Electric Surgical Instruments with Motor
- * Lumen Test Certification by EN13060 / EN867-5 :
 - Flexible Lumen : $\phi 1 \times 12,000$ mm
 - Stainless-steel Lumen : $\phi 1 \times 1,000$ mm
 - Single through Lumen : $\phi 1 \times 1,500$ mm
- * Special H₂O₂ Injection System
- * High-performance Microprocessor 7-inch Touch Screen Controller and LCD Display
- * Self-diagnose and display Error Code ; Stops Operation and Vents in case of Any Malfunction
- * Automatic Door Locking System for User Safety
- * Economical because of Using General 50% Hydrogen Peroxide(H₂O₂)
- * Efficient in Using Space with Compact Size Body & Squared Inner Chamber
- * Processing for Perfect Sterilizing :
 - Pre-Chamber Cleaning : Pre-Vacuum → H₂O₂ Injection → Diffusion
 - Plasma Sterilization : Vacuum → Plasma Processing & Sterilization → H₂O₂ Injection → Diffusion
 - Post Chamber Cleaning : Vacuum → Plasma Processing → Venting
- * Built-in Thermal Printer

Specifications & Ordering information

Spec.	Model	“MaXterile™ PS60”
Capacity		56 Lit
Sterilization Temp		Max. 60°C
Sterilization Agent		50% Hydrogen Peroxide
Vacuum Capacity		400 Lit / min
Operating Modes		Quick / Standard / Intense / Vacuum Test
Ambient Working Condition		Pressure : 700 ~ 1060 hPa, Temp : 10 ~ 40°C, Humidity : 30 ~ 75%
Controller & Display		Microprocessor 7" LCD Touch Screen Controller (Temp, Timer, Program Cycle, Vacuum)
Door-type		Push Interlocking Door System
Tray (Included)		2 Stainless-steel Perforated Tray
Safety Circuit		Over-Temp Protection, Current Leakage Breaker
Material		Interior : Reinforced & Electro Polished 304, Exterior : Stainless-steel 304
Dimension (w×d×h) & Weight	Interior	285×700×h285 mm
	Exterior	680×880×h890 mm, 172 kg
	Packing	720×900×h930 mm, 190 kg
Power Consumption		3.0 kW
Electric Reqts.		220 V, 50 / 60 Hz, 1 Phase
Cat. No.		DH.SteP8001
Price, Each. ₩		

* Other Specifications are available upon Customer's Request.

※ 운임 별도!

Spare Accessory

- DH.StePA1001 (1) STS Perforated Tray, 250×660 mm for “MaXterile PS60”
- DH.StePA1011 (2) Bottle with Hydrogen Peroxide(50%), 100 ml
- DH.StePA1012 Spare Bottle Only, $\phi 55 \times 124$ mm
- DH.SteA1006 Thermal Paper Package, 4 Paper Roll for Thermal Recorder
- DH.SteA1016 (3) Replacement Air Filter-kit

Ea. Price, ₩

Optional Accessory

- DH.StePA1015 Oil Mist Trap for “MaXterile PS60”
- DH.StePA1017 Oil for Vacuum Pump, 1Lit for “MaXterile PS60”
- DH.StePA1025 (4) Movable Stand with 1 Drawer, 680×865×h610 mm
- DH.StePA1030 Biological Indicator, 100ea.
- DH.StePA1031 Chemical Indicator, 250sheet.

Ea. Price, ₩

Articles	Cat. No	Description
----------	---------	-------------

DAIHAN® 130Lit Low Temp Plasma Sterilizer “MaXterile™ PS130”, Max. 60°C, **Class-II Medical Device(NIDS)** NEW
 Suitable for Medical Instrument, 50% Hydrogen Peroxide Injection, Microprocessor 10.4" Touch Screen Controller
 Front Door / SQUARE Chamber, with Emergency Stop Button, 2 Perforated STS Tray, **저온 플라즈마 멸균기**



130Lit Low Temp Plasma Sterilizer “MaXterile™ PS130”

- **Made in Korea** ■ **PL(Product Liability)**
- **with Certificate & Traceability : Controlled by Serial Number, Certificate, Delivery-information, and Traceable Data Base System.**
- **Speedy Sterilization Time within 30-60min, Economical Cycle Cost**
- **Environment Friendly : H₂O₂ Decomposes to Oxygen and Vapor Water, Leaving No Residues**
- * Ideal for Sterilization of Medical Instruments that are Vulnerable to High Temp, Steam & Pressure such as Surgical Endoscopes, Catheter, Electric Surgical Instruments with Motor
- * Lumen Test Certification by EN13060 / EN867-5 :
 - Flexible Lumen : φ 1 × 12,000 mm
 - Stainless-steel Lumen : φ 1 × 1,000 mm
 - Single through Lumen : φ 1 × 1,500 mm
- * Special H₂O₂ Injection System
- * High-performance Microprocessor 10.4-inch Touch Screen Controller and LCD Display
- * Self-diagnose and display Error Code ; Stops Operation and Vents in case of Any Malfunction
- * Automatic Door Locking System for User Safety
- * Economical because of Using General 50% Hydrogen Peroxide(H₂O₂)
- * Efficient in Using Space with Compact Size Body & Squared Inner Chamber
- * Processing for Perfect Sterilizing :
 - Pre-Chamber Cleaning : Pre-Vacuum → H₂O₂ Injection → Diffusion
 - Plasma Sterilization : Vacuum → Plasma Processing & Sterilization → H₂O₂ Injection → Diffusion
 - Post Chamber Cleaning : Vacuum → Plasma Processing → Venting
- * Built-in RS 232C & USB Memory, LAN Port * Foot Pedal for Easy Door Open Function
- * Built-in Thermal Printer

Specifications & Ordering information

Spec.	Model	“MaXterile™ PS130”
Capacity		130 Lit
Sterilization Temp		Max. 60°C
Sterilization Agent		50% Hydrogen Peroxide
Vacuum Capacity		25 m ³ / hr
Operating Modes		Quick / Standard / Intense / Vacuum Test
Ambient Working Condition		Pressure : 700 ~ 1060 hPa, Temp : 10 ~ 40°C, Humidity : 30 ~ 75%
Controller & Display		Microprocessor 10.4" LCD Touch Screen Controller (Temp, Timer, Program Cycle, Vacuum)
Door-type		Automatic Interlocking Door System
Trays (Included)		2 Stainless-steel Perforated Tray
Safety Circuit		Over-Temp / Protection, Current Leakage Breaker
Material		Interior : Reinforced & Electro Polished 304, Exterior : Stainless-steel 304
Dimension (w×d×h) & Weight	Interior	454×707×h404 mm
	Exterior	750×980×h1600 mm, 350 kg
	Packing	900×1150×h1800mm, 360 kg
Power Consumption		3.3 kW
Electric Reqts.		220 V, 50 / 60 Hz, 1 Phase
Cat. No.		DH.SteP8002
Price, Each. ₩		

* Other Specifications are available upon Customer's Request. ※ 운임 별도!

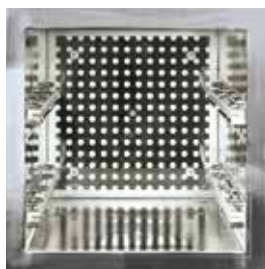

Square Inner Chamber



Built-in Port



(2) 50% H₂O₂ Bottle



(3) Air Filter-kit



(4) Oil Mist Trap

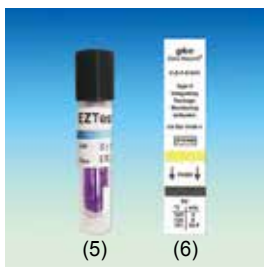

(5) Indicator
(6) Indicator

Spare Accessory

- DH.StePA1006** (1) STS Perforated Tray, 435×650×h30mm for “MaXterile PS130”
- DH.StePA1011** Bottle with Hydrogen Peroxide(50%), 100 ml
- DH.StePA1012** (2) Spare Bottle Only, φ55×124 mm
- DH.SteA1006** Thermal Paper Package, 4 Paper Roll for Thermal Recorder
- DH.SteA1016** (3) Replacement Air Filter-kit

Ea. Price, ₩

Optional Accessory

- DH.StePA1016** (4) Oil Mist Trap for “MaXterile PS130”
- DH.StePA1018** Oil for Vacuum Pump, 1Lit for “MaXterile PS130”
- DH.StePA1030** (5) Biological Indicator, 100ea.
- DH.StePA1031** (6) Chemical Indicator, 250sheet.

Ea. Price, ₩

Stirrer

Magnetic Stirrer, Magnetic Stirring <i>New</i>	P. 221~224
, Magnetic Stirring with Heating	P. 225~227
Overhead Stirrer, High Speed-type <i>New</i>	P. 229~231
, High Torque-type <i>New</i>	P. 232~235
, Jar Tester/6-paddle Stirrer	P. 236
, Accessory (Impeller/Rod/Stand)	P. 237~243

• **Magnetic Stirrer**

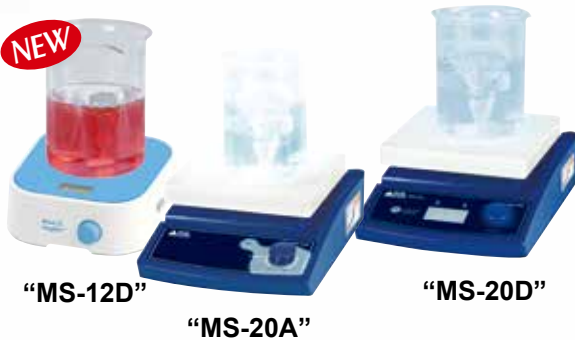

• **Magnetic Stirrer Multi-point**



• **Magnetic Stirrer with Heating**



• **Overhead Stirrer High Speed**



• **Magnetic Stirrer with Heating Multi-point**

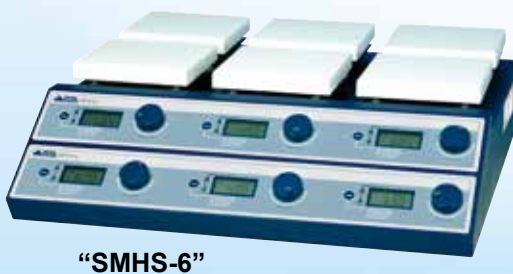

• **Overhead Stirrer High Torque**



Wisdom 120 × 120 Mini Hi-Quality Digital Magnetic Stirrer "MS-12D", Max. 2,500rpm **NEW**

With Tempered Glass Plate & PP Housing, BLDC-motor, Digital LED Display, Waterproof, Max. 2Lit(H₂O), 소형 디지털 자력교반기



120 × 120mm Mini Magnetic Stirrer "MS-12D"

- Made in Korea
- PL (Product Liability) Insurance
- High Performance Brushless DC-motor : High Efficiency Stirring Performance and Precise Speed Control (Minimize RPM Fluctuation), Low Maintenance Cost.
- Outstanding Chemical Resistance due to Tempered Glass Plate (120 × 120mm) and PP Housing
- Higher Speed Range from 100 ~ 2,500 rpm
- Waterproof Structure
- with Certificate & Traceability : Controlled by Serial Number, Certificate, Delivery-information, and Traceable Data Base System
- * Digital Speed LED Display.
- * Electronically Controlled Motor for more Capacity
- * Includes 1ea × 3cm Stirring Bar
- * Can be used with up to 5cm bar

Specifications & Ordering information

Spec.	Models	"MS-12D" 120 × 120mm Plate
Stirring Capacity		Max. 2Lit (H ₂ O)
Motor Rating (Input/Output)		6 / 3W
Speed Range & Motor		100~2,500rpm, High Performance Brushless DC-motor
Controller & Display		Digital PID Control with Jog-knob & Digital LED display
Stirring Bar		3cm bar-included, Usable : up to 5cm bar
Material		Tempered Glass Plate (5mm thick) & PP Housing
Dimension		Plate : 120 × 120mm, Body : 136 × 136 × h50.5mm
Weight		0.5kg
Electrical Reqts.		DC 12V, with AC 230V Adapter, 50/60Hz
Cat. No.	230V	DH.StiM012
	120V	DH.StiM012.1
Price, Set. ₩		

Wisdom 180 × 180 Midi Hi-Quality Digital Magnetic Stirrer "MS-18D", Max. 2,500rpm **NEW**

With Tempered Glass Plate & PP Housing, BLDC-motor, Digital LED Display, Waterproof, Max. 5Lit(H₂O), 미디 디지털 자력교반기



180 × 180mm Midi Magnetic Stirrer "MS-18D"

- Made in Korea
- PL (Product Liability) Insurance
- High Performance Brushless DC-motor : High Efficiency Stirring Performance and Precise Speed Control (Minimize RPM Fluctuation), Low Maintenance Cost.
- Outstanding Chemical Resistance due to Tempered Glass Plate (180 × 180mm) and PP Housing
- Higher Speed Range from 100 ~ 2,500 rpm
- Waterproof Structure
- with Certificate & Traceability : Controlled by Serial Number, Certificate, Delivery-information, and Traceable Data Base System
- * Digital Speed LED Display.
- * Electronically Controlled Motor for more Capacity
- * Includes 1ea × 3cm Stirring Bar
- * Can be used with up to 5cm bar

Specifications & Ordering information

Spec.	Models	"MS-18D" 180 × 180mm Plate
Stirring Capacity		Max. 5Lit (H ₂ O)
Motor Rating (Input/Output)		12 / 6W
Speed Range & Motor		100~2,500rpm, High Performance Brushless DC-motor
Controller & Display		Digital PID Control with Jog-knob & Digital LED display
Stirring Bar		3cm bar-included, Usable : up to 5cm bar
Material		Tempered Glass Plate (5mm thick) & PP Housing
Dimension		Plate : 180 × 180mm, Body : 193 × 193 × h80.5mm
Weight		1.6kg
Electrical Reqts.		DC 12V, with AC 230V Adapter, 50/60Hz
Cat. No.	230V	DH.StiM018
	120V	DH.StiM018.1
Price, Set. ₩		

DAIHAN® Standard Digital & Analog Magnetic Stirrer “MS-20”, 180×180mm Ceramic-Coated Plate, Max. 1,500rpm
 With Precise Speed Control, with Certi. & Traceability, Max. 20 Lit, 디지털/아날로그 자력교반기, 세라믹 코팅 플레이트



A. Digital Magnetic Stirrer “MS-20D”

- Made in Korea
- CE Certified
- PL (Product Liability) Insurance
- with Certificate & Traceability : Controlled by Serial Number, Certificate, Delivery-information, and Traceable Data Base System
- Ceramic Coated Plate-Chemical/Acid Resistance
- * Ideal for Heat-sensitive Procedures such as Microbiology and Biochemistry Applications
- * Mixing for Chemical, Laboratory, Pharmaceutical Materials
- * Smart Design of Body made by Aluminum Die-Casting
- * Powerful Motor for Stirring Quantities of up to 20Lit (Water)
- * Free Voltage (AC 80V ~ 240V, 50 / 60Hz) by SMPS

A. Digital Microprocessor Control System “MS-20D”

- Digital Feedback Control by High-Performance Microprocessor
- Patented Jog-Shuttle Control System
- * Digital LCD Display with Back-Light Function
- * Storage function for the set values : RPM and Time
- * Digital Timer Function : 99hr 59min(with Continuous run.)
- * Alarm Function : Error Status and Timer-End
- * Locking Mode Supported for Experimental Safety (Jog-shuttle input blocked)

B. Analog PWM Control System “MS-20A”

- * Superior Linearity for the Control of Stirring Speed by Specially Designed Control Circuitry (PWM Control)
- * Long Life Power & Mechanism
- * High Stability in Very Low & High-speed



B. Analog Magnetic Stirrer “MS-20A”

Specifications & Ordering information

Spec.	Model	A. “MS-20D” Digital-type	B. “MS-20A” Analog-type
Plate Size		180×180mm	
Stirring Capacity (H ₂ O)		Max. 20Lit	
Speed Range		80 ~ 1,500 rpm	Max. 1,500 rpm
Motor Rating		9 / 4 W	
Speed Accuracy (%)		± 5	-
Speed Control Resolution		5 rpm	-
Timer & Alarm		99hr 59min, Error status & Timer-end	-
Display		Digital LCD with Back-Light	-
Controller		Digital Feedback Controller with Jog Shuttle Switch(Turn+Push)	Superior Linearity PWM Controller
Stirring Bar		3cm bar-included, Usable : up to 5cm bar	
Permissible Ambient Temp.		Room Temp. +5 ~ 50°C	
Permissible Relative Moisture		85%	
Material	Plate	Ceramic Coated Aluminum (Chemical / Acid Resistance)	
	Body	Powder Coated Aluminum	
Dimension (w×d×h)		206×307×99mm	
Weight (kg)		3.1 kg	
Packing Size (w×d×h) & Gross Weight		280×400×200mm	
		5 kg	
Power Consumption		10 W	
Electrical Reqts.		Free Voltage (1 Phase, AC 80 ~ 240 V, 50 / 60 Hz)	
Cat. No.	230V	DH.WMS03022	DH.WMS03122
	120V	DH.WMS02022	DH.WMS02122
Price, Each. ₩			

* Other Specifications are available upon Customer's Request.

Long Life Power & Mechanism!

SMPS (Switching Mode Power Supply)
Use with Safety & Regular DC !!

Stable DC !!

SSR (Solid State Relay)-Non Contact
No Electronic Harm!
Realize **Long Life Cycle!**

High Stability in Very Low & High-speed

General Phase Control
Use with AC !!
(Very sensitive Point)

PWM Control
Use with DC !!
(Super linearity)

DAIHAN Realize **Stable & Easy to Use!**

Specialized Features of “MS-20A”

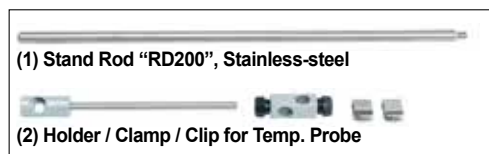

Optional Stand Rod/Holder/Clamp/Clip

- DH.WHP50306 (1) Stand Rod “RD200”, Stainless-steel, screw, φ12×L450mm, for “MS-20A/20D”
- DH.WHP503012 (2) Holder/Clamp/Clip, “CL220”, for Temp. Probe

Ea. Price, ₩

Articles	Cat. No	Description
----------	---------	-------------

DAIHAN® Premium Magnetic Stirrer “MaXtir™ MS500”, Shade Motor, Max. 80~1,500 rpm, Max 20Lit
 With Large LCD, Solid Ceramic Glass Plate, 200×200mm, Touch-button Controller, Digital Feedback Control, Precise Speed Control
 고성능 디지털 자력 교반기, 디지털 피드백 제어, 초강력 쉐이드 모터



Premium Digital Magnetic Stirrer “MaXtir™ MS500”

- Made in Korea ■ Ergonomic Design
- PL (Product Liability) Insurance
- with Certificate & Traceability : Controlled by Serial Number, Certificate, Delivery-information, and Traceable Data Base System
- Digital Feedback Control by High-Performance Microprocessor
- Brushless Shade Motor & Powerful Magnet ensures Powerful Stirring and Precise Speed Control
- High-quality Solid Ceramic Glass Plate : Heat-/Chemical-/Acid-Resistance and Easy to Clean
- Large LCD display for Current and Speed, and Timer
- Patented Controller “Jog-Dial” and Main Touch Button - Best Durability, Best Mobility, Best Convenient to Operate.
- * Mixing for Chemical, Laboratory, Pharmaceutical Materials
- * Storage Function for the set Values : RPM and Timer
- * Minimization of Noise and Improved the Product Life
- * Use of the Special Advanced Insulation for the safety of the Body Temp.
- * Locking Mode Supported for Experimental Safety (Input to Jog-Dial can be Disabled)
- * Large LCD with Back Light Function
- * Digital Timer Function(99hr 59min)
- * Ergonomic Design of Body made by Aluminum Die-casting

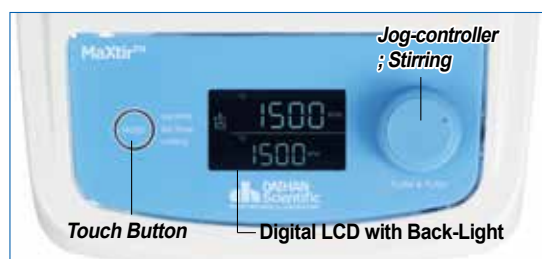

Controller of “MaXtir™ MS500”

Specifications & Ordering information

Spec.		Model	“MaXtir™ MS500”
Material	Body		Powder Coated Aluminum
	Plate		Solid Ceramic Glass Plate, 200×200mm
Stirring Capa.			Max. 20 Lit
Speed & Control Resolution			80 ~ 1,500 rpm, 5 rpm
Timer & Alarm			99hr 59min (with Continuous run.), Error status & Timer-end
Display			Large Digital LCD with Back-Light Function
Controller			Digital Feedback Controller with Jog Dial (Turn+Push) and Touch button.
Stirring Bar			3cm bar-included, Usable : up to 5cm bar
Permissible Temp. & RH %			Room Temp. +5 ~ 50℃, 85% RH
Dimension & Weight			200×332×h114mm, 3.8kg
Electrical Reqts.			1 Phase, AC 120 V, 60 Hz or AC 230 V, 50 / 60 Hz
Cat. No.	230V		DH.WMS00500
	120V		DH.WMS00501
Price, Each. ₩			

* Other Specifications are available upon Customer's Request.



Optional Stand Rod/Holder/Clamp/Clip

- DH.WHP503036 (1) Stand Rod, “RD200”, Stainless-steel, screw, φ12×L450mm
- DH.WHP503012 (2) Holder/Clamp/Clip, “CL220”, for Temp. Probe

Ea. Price, ₩

DAIHAN® Digital Multi-point Magnetic Stirrer “MS-MP”, 4-/8-Points, Max. 500ml per Point
 With Digital Feedback Control System, Digital LCD Display, Synchronous Operation, 80~1,200 rpm, with Certi. & Traceability
 4-/8-멀티포인트 디지털 자력교반기, 디지털 피드백 컨트롤 시스템



A. Digital 4-Point Magnetic Stirrer “MS-MP4”



B. Digital 8-Point Magnetic Stirrer “MS-MP8”

- Made in Korea ■ CE Certified ■ PL(Product Liability) Insurance
 - with Certificate & Traceability : Controlled by Serial Number, Certificate, Delivery-information, and Traceable Data Base System
 - Ideally Suitable for Use in Incubators and Climatic Chambers
 - Excellent for Multi-use and wide range of Sample Testing
 - Patented Jog-Shuttle Control System
- * Ideal for Heat-sensitive Procedures such as Microbiology and Biochemistry Applications
 - * Synchronous Operation of 4 / 8 Stirring Points
 - * Up to 0.5 Lit. Stirring Capacity per Point
 - * Increased Effectiveness by Microprocessor Control
 - * Digital LCD with Back-Light Function
 - * Digital Timer Function (99 hr 59 min)
 - * Smooth Start and Change of Stirring Speed
 - * Storage Function for the Set Values : RPM and Timer
 - * Extraordinary Mechanical, Physical and Chemical Resistance
 - * Locking Mode supported for Experimental Safety (Input to Jog-Shuttle can be Disabled)
 - * Free Voltage (AC 80V ~ 240V, 50 / 60Hz) by SMPS

Specifications & Ordering information

Spec.	Model	A. “MS-MP4” 4 Stirring Points	B. “MS-MP8” 8 Stirring Points
Number of Stirring Points		4 (2×2) Stirring Points	8 (4×2) Stirring Points
Plate Size		208×215mm	208×415mm
Stirring Capacity (H ₂ O)		Max. 0.5 Lit per Point	
Distance between Stirring Points		100 mm	
Speed Range		80 ~ 1,200 rpm	
Motor Rating		16/9 W	
Speed Control Resolution		5 rpm	
Timer & Alarm		99hr 59min (with Continuous run.), Error status & Timer-end	
Display		Digital LCD with Back-Light Function	
Controller		Digital Feedback Controller with Jog Shuttle Switch(Turn+Push)	
Stirring Bar		4ea 3cm bar-included, Usable : up to 3cm bar	8ea 3cm bar-included, Usable : up to 3cm bar
Permissible Ambient Temperature		Room Temp. +5 ~ 50°C	
Permissible Relative Moisture		85%	
Material	Plate	Stainless-steel (# 304)	
	Body	Power Coated Steel	
Dimension (w×d×h)		208×280×75mm	208×480×75mm
Weight		2.5 kg	3.5 kg
Others		CE Certified, PL(Product Liability) Insurance	
		Storage Function (RPM, Timer) Locking Mode (Jog-Shuttle Input Disabled) Alarm (Error Status and Timer-end)	
Packing Size (w×d×h) & Gross Weight		300×330×180mm	330×540×180mm
Power Consumption		20 W	
Electrical Reqt.s.		Free Voltage (1 Phase, AC 80 ~ 240 V, 50 / 60 Hz)	
Cat. No.	230V	DH.WMS03036	DH.WMS03038
	120V	DH.WMS02036	DH.WMS02038
Price, Each. ₩			

* Other Specifications are available upon Customer's Request.

DAIHAN® 500°C High-Temp Premium Hotplate Stirrer “MaXtir™ MSH500”, Solid Ceramic Glass Plate, 200×200mm With Large LCD, Optimum Insulation Layer. Accurate Temp. Control, Touch-button Controller, Hot-Top Indicator, 80~1,500rpm 고온용 디지털 가열 자력 교반기, 최적의 방열구조, 디지털 피드백 온도 제어, 내열성/내화학성/내산성 슬리드 세라믹 글라스 플레이트

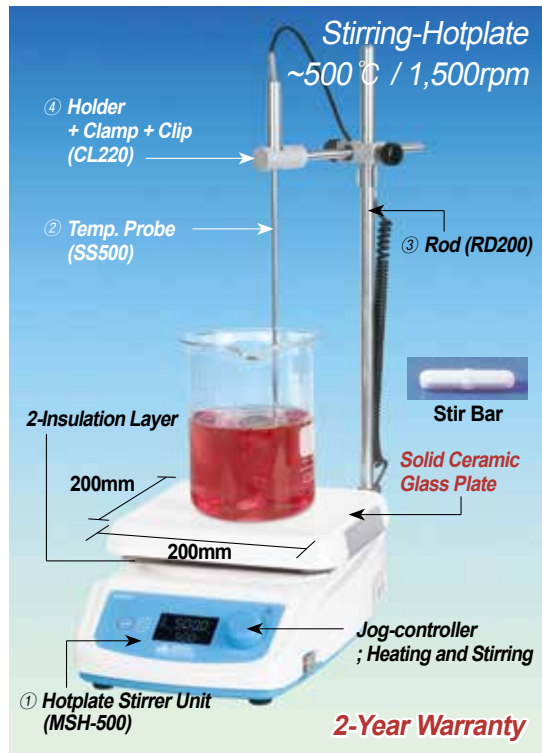

A. “MaXtir™ MSH500” Package-set



B. “MaXtir™ MSH500” Unit only

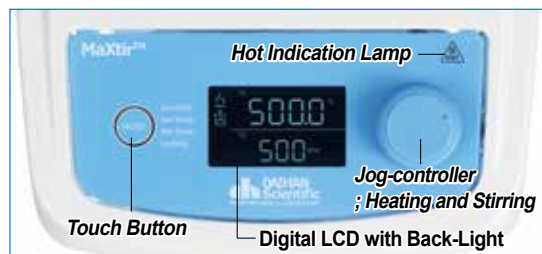

Controller of “MaXtir™ MSH500” model



- Made in Korea ■ PL(Product Liability) Insurance ■ Ergonomic Design
- with Certificate & Traceability : Controlled by Serial Number, Certificate, Delivery-information, and Traceable Data Base System
- High-quality Solid Ceramic Glass Plate : Heat-/Chemical-/Acid-Resistance and Easy to Clean
- Optimum Insulation Fourfold Layer : BTU + Ceramic Paper + 2 SUS Insulation Layer
- Brushless Shade Motor & Powerful Magnet ensures Powerful Stirring and Precise Speed Control, Minimization Noise
- Maximum Temperature of 500°C ■ Microprocessor PID control
- Patented Controller “Jog-Dial” and Main Touch Button - Best Durability, Best Mobility, Best Convenient to Operate with Back-Light Function
- 2 Internal K-type Temp. Sensor Operating Independently : 1 Temp. Control Sensor for Temperature Accuracy and 1 Over Temp. Detection Sensor for User Safety
- Hot Top Indicator LED Lamp : Hot Surface(Over 50°C) Warning Lamp for User Safety
- * Excellent for Sample Drying and most General Lab Heating Applications
- * User’s Self-Compensation Function : to Control Difference between Real Temp. and Indicated Temp. (±20.0°C)
- * Accurate Temp. Control of the Sample in the Vessel using PT100 Sensor (Optional)
- * Storage Function for the set Values : Temp. and Timer
- * Minimization of Noise and Improved the Product Life
- * Use of the Special Advanced Insulation for the safety of the Body Temp.
- * Locking Mode Supported for Experimental Safety (Input to Jog-Dial can be Disabled)

Specifications & Ordering information

Spec.		Model	A. “MaXtir™ MSH500” (Package-set)	B. “MaXtir™ MSH500” (Unit Only)
Material	Body	Powder Coated Aluminum		
	Plate	Solid Ceramic Glass Plate, 200×200mm		
Stirring Capa.		Max. 20 Lit		
Speed & Control Resolution		80 ~ 1,500 rpm, 5 rpm		
Temp. Range & Accuracy		Max. 500°C, ±0.3°C at Set Temperature		
Temp. Resolution		0.1°C-Display, 0.5°C-Control		
Temp. Uniformity		Specially Designed Heating Module : Temp. Difference 10% less		
Heating Power / Consumption		850W		
Timer & Alarm		99hr 59min (with Continuous run.), Error status & Timer-end		
Display		Digital LCD with Back-Light Function		
Controller		Digital Feedback Controller with Jog Dial (Turn+Push) and Touch button.		
Stirring Bar		3cm bar-included, Usable : up to 5cm bar		
Safety Circuit		Over Temp. Protection, Hot Top Indicator LED Lamp		
included Standard Acc.		1ea Stir Bar, ②Temp. Probe ③Rod ④Holder+Clamp	1ea Stir Bar	
Permissible Temp. & RH %		Ambient +5 ~ 50°C, 85% RH		
Dimension & Weight		200×332×h114mm, 3.8kg		
Electrical Reqts.		1 Phase, AC 120 V, 60 Hz or AC 230 V, 50 / 60 Hz, with Cord/Plug		
Cat. No.	230V	DH.WMH00500	DH.WMH01500	
	120V	DH.WMH00501	DH.WMH01501	
Price, Each. ₩				

* Other Specifications are available upon Customer’s Request.

Component of Package-set

- * Package-set : ① Hotplate Stirrer Unit ② “SS500” PT100 External / Direct Contact Temp. Probe, ③ “RD200” Stainless-steel Support Rod φ12×L450mm ④ “CL220” Holder+Clamp+Clip for External Temp. Probe

Optional External Temp Probe/Stand Rod/Holder/Clamp/Clip

	Ea. Price, ₩
DH.WHP503060 (1) External / Direct Contact Temp. Probe, “SS500”, Stainless-steel, φ4×L250mm, Cable L190mm	
DH.WHP503061 (2) External / Direct Contact Temp. Probe, “SS510”, Teflon Coated, φ4×L250mm, Cable L190mm,	
DH.WHP503036 (3) Stand Rod “RD200”, Stainless-steel, φ12×L450mm, 1.5p screw, for “MaXtir™ MSH500”	
DH.WHP503012 (4) Holder/Clamp/Clip, “CL220”, for Temp. Probe	

DAIHAN® 380°C Standard Analog & Digital Hotplate Stirrer “MSH-A” & “MSH-D”, Ceramic-Coated Plate, 80~1,500 rpm 180×180mm or 260×260mm Plate, with Accurate Temp. Control, Superior Temp. Uniformity, with Certi. & Traceability
 아날로그 & 디지털 가열 자력 교반기, 우수한 온도제어/온도균일성, 세라믹 코팅 플레이트

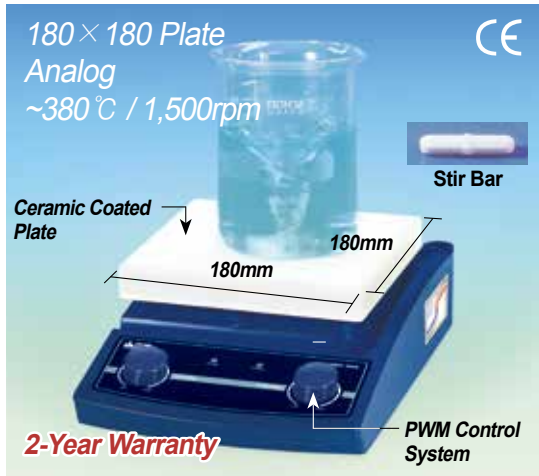

(I-A) Analog “MSH-20A”, 180×180mm Plate-type

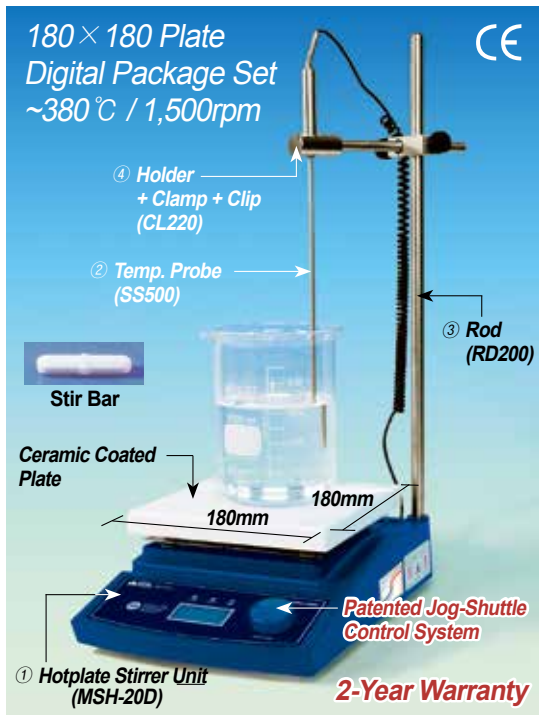

(III-A) Digital “MSH-20D” Package-set, 180×180mm Plate-type



(I-B) Analog “MSH-30A”, 260×260mm Plate

(II-B) Digital “MSH-30D”, 260×260mm Plate



- Made in Korea
- CE Certified
- PL(Product Liability) Insurance
- with Certificate & Traceability : Controlled by Serial Number, Certificate, Delivery-information, and Traceable Data Base System
- Excellent for Sample Drying and most General Lab Heating Applications

I. Analog PWM Control System “MSH-A”

* Superior Linearity PWM Control for Temperature & Stirring Speed

II. Digital Microprocessor Control System “MSH-D”

■ Patented Jog-Shuttle Control System

- * Speed & Control Resolution : 80 ~ 1,500 rpm, 5 rpm
- * Temp. Accuracy / Resolution : ±0.3°C at Set Temp. / 0.1°C-Display, 0.5°C-Control
- * Timer & Alarm : 99hr 59min(with Continuous run), Error status & Timer-end
- * Safety Circuit : Over Temp. Protection
- * User's Self-Compensation : Control Difference between Real Temp. & Indicated Temp. (±20.0°C)
- * Accurate Temp. Control of the Sample in the Vessel using PT100 Sensor
- * Storage Function for the set Values : Temp. and Timer
- * Locking Mode Supported for Experimental Safety (Input to Jog-Shuttle can be Disabled)

III. Digital Package-set ; Complete with

- * III-A. “MSH-20D” Set : ① Hotplate Stirrer “MSH-20D”, ② “SS500” PT100 External / Direct Contact Temp. Probe, ③ “RD200” Stainless-steel Support Rod $\phi 12 \times L450$ mm, ④ “CL220” Holder+Clamp+Clip for External Temp. Probe
- * III-B. “MSH-30D” Set : ① Hotplate Stirrer “MSH-30D”, ② “SS500” PT100 External / Direct Contact Temp. Probe, ③ “RD100” Stainless-steel Support Rod $\phi 12.7 \times L390$ mm, ④ “CL220” Holder+Clamp+Clip for External Temp. Probe

Specifications & Ordering information

Spec.	Model	A. 180×180mm Plate (I-A) Analog “MSH-20A” (II-A) Digital “MSH-20D”	B. 260×260mm Plate (I-B) Analog “MSH-30A” (II-B) Digital “MSH-30D”
		Plate Size(mm)	
Material	Body	Powder Coated Aluminum	Powder Coated steel
	Plate	Ceramic Coated Aluminum (Chemical / Acid Resistance, Easy to Clean)	
Stirring Capa. & Motor Rating	Max. 20Lit, 9 / 4W		
Temp. Uniformity	Specially Designed Heating Module : Temp. Difference 10% less		
Heating Power/Consumption		600W	1.2kW
Stirring Bar	3cm bar-included, Usable : up to 5cm bar		
Permissible Temp. & RH %	Ambient +5 ~ 50°C, 85% RH		
Dimension & Weight		206×307×h99mm, 3.3kg	286×387×h99mm, 3.5kg
Packing Size & Gross Weight		400×280×h200mm, 5kg	430×320×h200mm, 5kg
Electrical Reqts.	1 Phase, AC 120V, 60Hz or AC 230V, 50 / 60Hz		

I. Analog Unit Only		(I-A) “MSH-20A”	(I-B) “MSH-30A”
Cat. No.	230V	DH.WMH03120	DH.WMH03121
	120V	DH.WMH02120	DH.WMH02121
Price, Each. ₩			

II. Digital Unit Only		(II-A) “MSH-20D”	(II-B) “MSH-30D”
Cat. No.	230V	DH.WMH03020	DH.WMH03022
	120V	DH.WMH02020	DH.WMH02022
Price, Each. ₩			

III. Digital Package-set		(III-A) “MSH-20D” Set	(III-B) “MSH-30D” Set
Cat. No.	230V	DH.WMH03021	DH.WMH03023
	120V	DH.WMH02021	DH.WMH02023
Price, Each. ₩			

* Other Specifications are available upon Customer's Request.

Optional External Temp Probe/Stand Rod/Holder/Clamp/Clip

- DH.WHP503060 (1) Temp. Probe, “SS500”, “PT100”, $\phi 4 \times L250$ mm
- DH.WHP503061 (2) Teflon Coated Temp. Probe, “SS510”, $\phi 4 \times L250$ mm
- DH.WHP503011 Stand Rod, “RD100”, $\phi 12.7 \times L390$ for “MSH-30A / 30D”
- DH.WHP503036 “RD200”, $\phi 12 \times L450$ for “MSH-20A / 20D”
- DH.WHP503012 Holder / Clamp / Clip, “CL220”, for Temp. Probe

Ea. Price, ₩

Articles	Cat. No	Description
----------	---------	-------------

DAIHAN® 350°C Systematic Multi-Hotplate Stirrer "SMHS", 3- or 6-Places, Ceramic-Coated Plate
 With Digital Feedback Control, Independent Heating & Stirring Control, up to 350°C, 80~1,500 rpm
 멀티 가열 자력 교반기, 우수한 온도균일성, 3- or 6- 구 개별 조절 가능

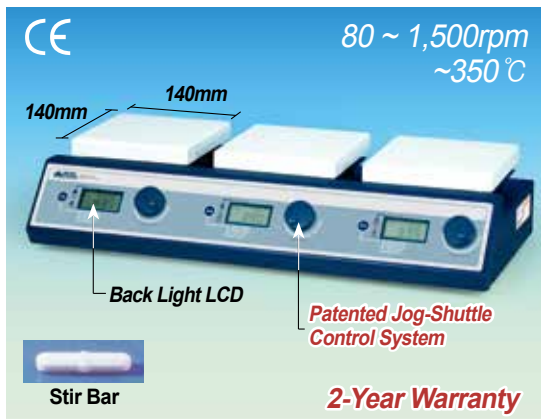

A. 3 Plate-type Multi-Hotplate Stirrer "SMHS-3"

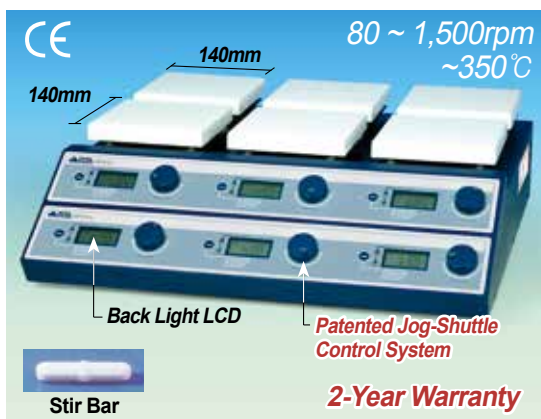

B. 6(3×2) Plate-type Multi-Hotplate Stirrer "SMHS-6"

- Made in Korea
- CE Certified
- PL(Product Liability) Insurance
- with Certificate & Traceability : Controlled by Serial Number, Certificate, Delivery-information, and Traceable Data Base System
- Excellent for Multi-use and wide range Sample Testing
- Patented Jog-Shuttle Control System
- * Systemized 3- and 6-Hotplate Stirrer
- * Independent Heating and Stirring Control
- * Digital Feedback Control by High-Performance Microprocessor
- * Ceramic Coated Plate-Chemical/Acid Resistance
- * Maximum Temperature of 350°C with ±0.3°C Control Accuracy
- * Accurate Temp. Control of the Sample in the Vessel using PT100 Sensor (Optional)
- * Digital LCD with Back-Light Function
- * Digital Timer Function Included : 99 hr 59 min
- * Storage Function for the Set Values : Temperature, RPM and Timer
- * Locking Mode for Experimental Safety Supported

Specifications & Ordering information

Spec.	Model	A. "SMHS-3" 3 Plates	B. "SMHS-6" 6 Plates
Plate-type		3 Plate-type	6(3×2) Plate-type
Plate Size		140×140mm	
Stirring Capa. & Motor Rating		Max. 20 Lit(H ₂ O), 9/4W×3	Max. 20 Lit(H ₂ O), 9/4W×6
Speed & Control Resolution		80 ~ 1,500 rpm, 5 rpm	
Temp. Range & Accuracy		Max. 350 °C, ±0.3°C at Set Temp.	
Temp. Resolution		0.1 °C-Display, 0.5 °C-Control	
Temp. Uniformity		Specially Designed Heating Module : Temp. Difference 10% less	
Heating Power/Consumption		400 W × 3 Plates	400 W × 6 Plates
Timer & Alarm		99hr 59min (with Continuous run.), Error status & Timer-end	
Display		Digital LCD with Back-Light Function	
Controller		Digital Feedback Controller with Jog Shuttle Switch (Turn+Push)	
Stirring Bar		3cm bar-included, Usable : up to 5cm bar	
Ports for Stand Rod		2ea	4ea
Permissible Temp. & RH %		Room Temp. +5 ~ 50°C, 85% RH	
Material	Body	Powder Coated steel	
	Plate	Ceramic Coated Aluminum	
Dimension & Weight		510×240×h100mm, 10kg	510×410×h180mm, 18kg
Packing Size & Gross Weight		540×330×h170mm, 10kg	570×540×h230mm, 18kg
Electrical Reqts.		1 Phase, AC 120 V, 60 Hz or AC 230 V, 50 / 60 Hz	

Cat. No.	230V	DH.WMH03503	DH.WMH03506
	120V	DH.WMH02503	DH.WMH02506
Price, Each. ₩			

* Other Specifications are available upon Customer's Request. ※ 운임 약 ₩ 9,000 별도!

Optional External Temp Probe/Stand Rod/Holder/Clamp/Clip

- DH.WHP503060 (1) External / Direct Contact Temp. Probe, "SS500", Stainless-steel, φ4×L250mm, Cable L190mm
- DH.WHP503061 (2) External / Direct Contact Temp. Probe, "SS510", Teflon Coated, φ4×L250mm, Cable L190mm,
- DH.WHP503036 (3) Stand Rod "RD200", Stainless-steel, 1.5p screw, φ12×L450mm, for "SMHS"
- DH.WHP503012 (4) Holder/Clamp/Clip, "CL220", for Temp. Probe

Ea. Price, ₩



DAIHAN® Overhead Stirrer Selection Guide of Product Line

Key Specification of Product Line

Speed or High Torque	High Speed							High Torque									
	Analog Model		Digital Model					Analog Model		Digital Model							
Controller Type	Integrated Controller		Integrated Controller		Remote Controller		New PREMIUM Digital Model OVS-S05	Integrated Controller		Integrated Controller		Remote Controller			New PREMIUM Digital Model OVS-T16 OVS-G30		
	HS-50A	HS-120A	HS-30D	HS-100D	HS-30T	HS-100T		HT-50AX	HT-120AX	HT-50DX	HT-120DX	HT-50T	HT-120T	HT-140T	OVS-T16	OVS-G30	
Max. Stirring Capacity(H ₂ O)	10Lit	20Lit	10Lit	20Lit	10Lit	20Lit	100Lit	40Lit	60Lit	40Lit	60Lit	40Lit	60Lit	100Lit	100Lit	100Lit	
Max. Viscosity(mPas) (Viscosity Standard Oil 1.5Lit)	5,000	10,000	5,000	10,000	5,000	10,000	50,000	60,000	90,000	60,000	90,000	60,000	90,000	120,000	200,000	350,000	
Motor Rating (Input / Output)	83W /75W	130W /120W	83W /75W	130W /120W	83W /75W	130W /120W	200W /180W	83W /75W	130W /120W	83W /75W	130W /120W	83W /75W	130W /120W	130W /120W	200W /180W	200W /180W	
Max. Torque (N·cm)	70	80	70	80	70	80	200	180	210	180	210	180	210	300	700	800	
Speed Range (RPM)	200 ~ 3,000							50 ~ 1,000								50 ~ 2,000	10 ~ 550
Max. Push Through Shafts φ (mm)	8						10										
Max. Chcuk Grip Capa. φ (mm)	10							12							10		
Controller	Analog Phase Controller		Digital Feedback Controller with Jog Shuttle Switch (Turn+Push)		Digital Feedback Controller with Jog Shuttle Switch (Turn+Push), Remote type		Digital Feedback Controller with Jog Shuttle Switch (Turn + Push)	Analog Phase Controller		Digital Feedback Controller with Jog Shuttle Switch (Turn+Push)		Digital Feedback Controller with Jog Shuttle Switch (Turn+Push), Remote type			Digital Feedback Controller with Jog Shuttle Switch (Turn+Push)		
Display	None		Back Light LCD					None		Back Light LCD							
Permissible Temp. & Humidity	0 ~ 40°C / 80%																
Power Supply	1 Phase, AC 120 V, 60 Hz or AC 230 V, 50 / 60 Hz																

Selection Guide for Standard Viscosity

(Unit : mPas)

Material	Viscosity	Recommended Models														
Water	1	HS-50A HS-30D HS-30T	HS-120A HS-100D HS-100T	OVS-S05	HT-50AX HT-50DX HT-50T	HT-120AX HT-120DX HT-120T	HT-140T	OVS-T16	OVS-G30							
Milk	3															
Soybean oil	160															
Varnish	500															
Lacquer	1,000															
Honey	3,000															
Viscosity Standard Oil	5,000															
	10,000															
	15,000															
Ketchup	30,000															
Viscosity Standard Oil	50,000															
	60,000															
Mustard	70,000															
Viscosity Standard Oil	90,000															
Corn Syrup	100,000															
Viscosity Standard Oil	120,000															
	150,000															
	200,000															
Peanut Butter	250,000															
Viscosity Standard Oil	350,000															

DAIHAN® PREMIUM Hi-Speed Overhead Stirrer “OVS-S05”, with Hi-Capacity BLDC-motor, 2:1, Max. 3,000rpm **NEW**
 With Torque(Ncm)- / Viscosity(mPas)- / Temperature(°C)-Real Time Display, Optional Remote Control, 50,000mPas, Max. 100Lit
 프리미엄 고속 교반기, 저/중점도용, 고사양 BLDC-motor, 토크- / 점도- / 온도-표시기능, “Push-Through” Shaft(φ 10mm or Less)



A. Max. 100Lit (H₂O) PREMIUM “OVS-S05” Unit Only



B. Max. 100Lit (H₂O) PREMIUM “OVS-S05” Package-set

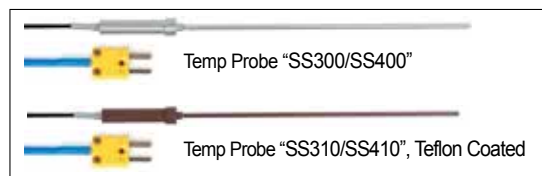

(1) Direct Contact Temp Probes, K-type (Optional)



(2) K-type PTFE Encapsulated Stainless-steel Thermocouple Probe (Optional)

- Made in Korea
- PL (Product Liability) Insurance
- Patented Jog Dial & Touch Button
- Hi-Capacity Brushless DC-motor : High Efficiency Stirring Performance and Precise Speed Control(Minimize RPM Fluctuation), Low Maintenance Cost
- Torque Value(Ncm)-/Viscosity(mPas)-/Temperature(°C) Real-time Display Can be used with K-type Temp. Probe for Temperature Display.
- Can be used with Optional Digital Remote Controller.
- “Push-Through” Shafts(φ10mm or Less) ; Ideal for Raising or Lowering the Stir-Shafts without Moving the Motor Head - “Adjustable Height of Shaft”
- with Certificate & Traceability : Controlled by Serial Number, Certificate, Delivery-information, and Traceable Data Base System
- * Ideal for Low-/Middle-Viscosity * Smooth Start and Change of the Stirring Speed.
- * Large Size Digital LCD Display

Specifications & Ordering information

Spec.	Model	“OVS-S05” Max. Speed 3,000rpm
Stirring Capacity		Max. 100 Lit (H ₂ O)
Maximum Viscosity / Torque		50,000 mPas / 200 Ncm
Speed Range & Motor		200 ~ 3,000RPM, Hi-Capacity Brushless DC-motor, 2:1
Motor Rating (Input / Output)		200 / 180W
Controller / Safety Device		Digital PID Control / Over Heat & Current Protector for Motor
Chuck Grip Capa. φmm		dia φ3~10mm Shafts, Flex-Coupling(φ6~12mm)
“Push-Through” Shafts		dia φ10mm or Less
Permissible Temp. & Humidity		0 ~ 40 °C, 80%
Dimension & Weight & Material		84×205×h275mm, 3.5kg, Aluminum Die Casting
Power Consumption		250W
Electrical Reqts.		1 Phase, AC 120V, 60 Hz or AC 230 V, 50 / 60 Hz

* Other Specifications are available upon Customer’s Request

A. Unit-only

Model	Description	Ea. Price, ₩
DH.StiO0005	Hi-Speed Overhead Stirrer Unit “OVS-S05”, 230V	
DH.StiO0005.1	, 120V	

B. Package-set

- * Complete with ① “OVS-S05” StirrerUnit
- ② “S723” Stainless-steel Impeller (Rod φ8×L650mm, 3-Blade φ80mm)
- ③ “CL200” Clamp
- ④ “KA1177” Safety Stand (Rod φ23×L800mm, Base 34×29cm)

Model	Description	Ea. Price, ₩
DH.StiO0105	Overhead Stirrer “OVS-S05” Package-set, 230V	
DH.StiO0105.1	, 120V	

C. Optional Digital Remote Controller, with Connecting Cable 1.5m

- * Assembly-type, Torque / Viscosity / Temp-Control & Display
- * Connecting Cable 1.5m(Included) and 2m(Optional)
- * Size : w75×d150×h30mm, Weight : 150g

Model	Description	Ea. Price, ₩
DH.WOS50010	Digital Remote Controller with 1.5m Connecting Cable & Plug	
DH.Cabi002	Optional Connecting Cable & Plug, 2m	

Optional Temperature Probe

(1) Direct Contact Temp Probe, K-type

Model	Description	Ea. Price, ₩
DH.WHP503040	Temp Probe, K-type, “SS300”, L250×φ 4.8 mm	
DH.WHP503050	“SS400”, L380×φ 4.8 mm	
DH.WHP503041	Temp Probe, K-type, “SS310”, Teflon Coated, L250×φ 5 mm	
DH.WHP503051	“SS410”, Teflon Coated, L380×φ 5 mm	

(2) K-type PTFE Encapsulated Stainless-steel Thermocouple Probe

※ Note! For the Optional Probe ⇒ See the “Measuring, Thermometer” Section
 For the Optional Impeller ⇒ See the “Stirrer, Accessory” Section

DAIHAN® High-Speed Analog Overhead Stirrer "HS-A", for Low-/Middle-Viscosity, Max. 10 · 20Lit, Max. 3,000rpm
 With "Push-Through" Shaft(φ8mm or Less) and Chuck grip φ3~10mm, Flex-Coupling φ6~12mm, up to 5,000 · 10,000mPas
 아날로그 고속 교반기, 저/중점도용, 사용교반봉 ; ①기본은 φ3~10mm, ②관통은 φ3~8mm, & ③별도의 Flex-Coupling 활용시 φ6~12mm



Max. 10 Lit (H₂O) High-Speed Analog Overhead Stirrer "HS-50A" Package-set

- Made in Korea ■ CE Certified ■ PL (Product Liability) Insurance
- Ensure Minimize RPM Fluctuation : Very Stable Stirring Speed(RPM) Performance
- * with Certificate & Traceability : Controlled by Serial Number, Certificate, Delivery-information, and Traceable Data Base System
- * "Push-Through" Shafts(φ8mm or Less) ; Ideal for Raising or Lowering of the Stir-Shafts without Moving the Motor Head - "Adjustable Height of Shaft"
- * Easy-to-use Dial for Speed Setting * Smooth Start and Change of the Stirring Speed

Specifications & Ordering information

Spec.	Models	"HS-50A" Max. Stirring Capa. 10 Lit	"HS-120A" Max. Stirring Capa. 20 Lit
Stirring Capacity		Max. 10 Lit (H ₂ O)	Max. 20 Lit (H ₂ O)
Maximum Viscosity / Torque		5,000 mPas / 85 Ncm	10,000 mPas / 145 Ncm
Speed Range & Motor		200 ~ 3,000 rpm, Direct Driven DC Motor	
Motor Rating (Input / Output)		83 / 75 W	130 / 120 W
Controller / Safety Device		Analog Phase Controller / Over Heat Protector for motor	
Chuck Grip Capa. φ mm		dia φ3~10mm Shafts	
"Push-Through" Shafts		dia φ8mm or Less	
Permissible Temp. & Humidity		0 ~ 40°C, 80%	
Material		ABS and Aluminum	
Dimension & Weight		90 × 145 × h180mm, 4.5 kg	90 × 145 × h180mm, 5.3 kg
Packing Size & Gross Weight		320 × 300 × h180mm, 5 kg	320 × 300 × h180mm, 8 kg
Power Consumption		85 W	130 W
Electrical Reqts.		1 Phase, AC 120 V, 60 Hz or AC 230 V, 50 / 60 Hz	

Unit-only

Cat. No.	230V	DH.WOS01210	DH.WOS01215
	120V	DH.WOS02210	DH.WOS02215
Price, Each. ₩			
Package-set (with ① Stirrer Unit, ② Impeller, ③ Clamp, ④ Stand)			
Cat. No.	230V	DH.WOS01211	DH.WOS01216
	120V	DH.WOS02211	DH.WOS02216
Price, Each. ₩			

* Other Specifications are available upon Customer's Request.

- * "HS-50A" Package-set : Complete with ① "HS-50A" Stirrer Unit, ② "S721" Stainless-steel Impeller (Rod φ8 × L500mm, 3-Blade φ50mm), ③ "CL200" Clamp, and ④ "KA1177" Safety Stand (Rod φ23 × L800mm, Base w34 × d29cm)
- * "HS-120A" Package-set : Complete with ① "HS-120A" Stirrer Unit, ② "S723" Stainless-steel Impeller (Rod φ8 × L650mm, 3-Blade φ80mm), ③ "CL200" Clamp, and ④ "KA1177" Safety Stand (Rod φ23 × L800mm, Base w34 × d29cm)

The Figure ;
Use of Coupling

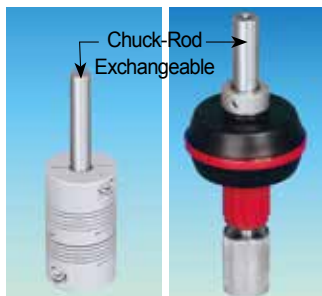
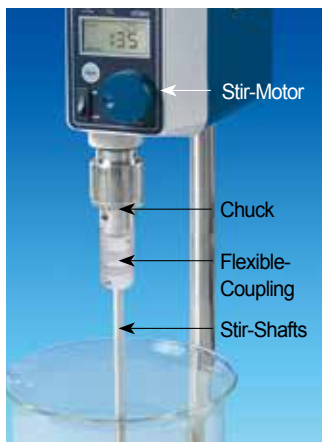

(1) Hi-flex Metal ; (2) Rubber Based for φ6~12 Shafts ; for φ7~10 Shafts

Flexible Coupling, for Safety Stirring of φ6~12mm Shafts of Overhead Stirrers
 for Stirrers between Stirring Motor and Shaft, 안전교반용 유연성 커플링

■ Used to Compensate Any Vibrations Between The Motor and Stirring Shafts

(1) UTILITY High-Flex. Metal Coupling, with 2 × Flex-band, for φ6~12mm Stir-Shafts
 Ideal for Low/High Viscosity and High/Low Speed

- * Made in Korea * Shaft Fastening by Screw Clamp Band * Made of DURALUMIN
- * with Exchangeable STS Chucking Rod φ8 & 10mm, L40mm

SL.StiC011	Stir-Coupling, Hi-flex, φ8mm Chuck-rod , for-φ6mm Stir-Shaft , 56g, φ25 × h44mm	Ea.	Price, ₩
SL.StiC012	-φ8mm Stir-Shaft , 53g, φ25 × h44mm		
SL.StiC013	-φ10mm Stir-Shaft, 49g, φ25 × h44mm		
SL.StiC014	Stir-Coupling, Hi-flex, φ10mm Chuck-rod, for-φ8mm Stir-Shaft , 49g, φ25 × h44mm		
SL.StiC015	-φ10mm Stir-Shaft, 43g, φ25 × h44mm		
SL.StiC016	-φ12mm Stir-Shaft, 33g, φ25 × h44mm		

(2) Very Flexible Rubber Based Coupling, for φ7~10mm Shafts
 Especially, Ideal for GLASS Shafts and Low/Middle Viscosity & High Speed

- * Made in Germany * Shaft Fastening by Screw Compression Rubber Ring Pad.
- * with φ10 × L40mm Exchangeable Stainless-steel Chucking Rod

WL.1445000	Stir-Coupling, Rubber Based, for φ7~φ10mm Shafts, 72.5g, Body φ46 × h80mm	Ea.	Price, ₩
* Note! Details of Wide-Range Coupling : See the "Stirrer Accessory"			

DAIHAN® High-Speed Digital Overhead Stirrers “HS-D” & “HS-T”, for Low-/Middle-Viscosity, Max. 10 · 20Lit
 With “Push-Through” Shaft and Chuck grip $\phi 3\sim 10\text{mm}$, Flex-Coupling $\phi 6\sim 12\text{mm}$, Max. 3,000rpm, up to 5,000 · 10,000mPas
 디지털 고속 교반기, 저/중점도용, 사용교반용 ; ①기본은 $\phi 3\sim 10\text{mm}$, ②관통은 $\phi 3\sim 8\text{mm}$, & ③별도의 Flex-Coupling 활용시 $\phi 6\sim 12\text{mm}$



(I-A) Max. 10 Lit (H₂O) High-Speed Digital Overhead Stirrer “HS-30D” Package-set

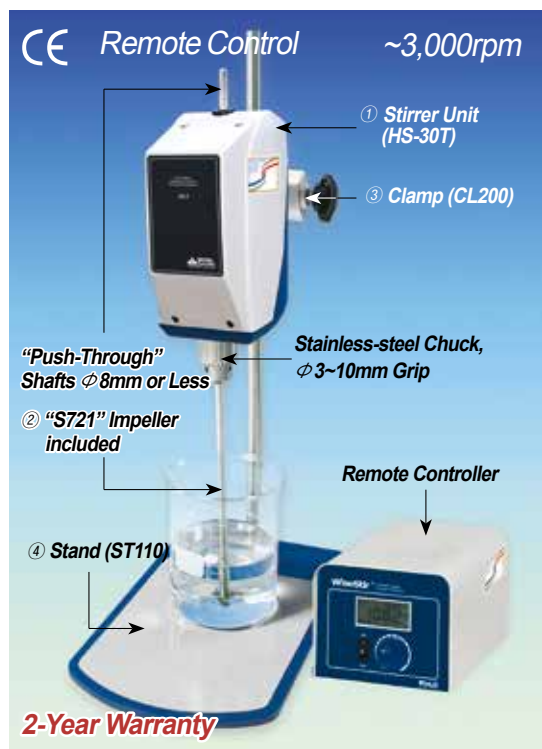

(II-A) Max. 10 Lit (H₂O) High-Speed Digital Overhead Stirrer, with Remote Controller “HS-30T” Package-set

- Made in Korea ■ CE Certified ■ PL(Product Liability) Insurance
- Ensure Minimize RPM Fluctuation : Very Stable Stirring Speed(RPM) Performance
- Patented Jog-Shuttle Control System
- * with Certificate & Traceability : Controlled by Serial Number, Certificate, Delivery-information, and Traceable Data Base System
- * “Push-Through” Shafts($\phi 8\text{mm}$ or Less) ; Ideal for Raising or Lowering of the Stir-Shafts Moving the Motor Head - “Adjustable Height of Shaft”
- * Smooth Start and Change of the Stirring Speed

I. Digital Standard-type “HS-D”

Spec.	Models	(A) “HS-30D”	(B) “HS-100D”
		Max. Stirring Capa. 10 Lit	Max. Stirring Capa. 20 Lit
Maximum Viscosity / Torque		5,000 mPas / 70 Ncm	10,000 mPas / 80 Ncm
Speed Range & Resolution		200 ~ 3,000 rpm, 1 rpm-Display / 1 rpm-Control	
Motor / Safety		Device Direct Driven DC Motor / Overload & Heat Protector for Motor	
Motor Rating (Input / Output)		83 / 75 W	130 / 120 W
Timer & Alarm		99hr 59min (with Continuous run.), Error status & Timer-end	
Controller / Display		Digital Feedback Controller / Digital LCD with Back-Light Function	
Chuck Grip Capa. ϕ mm		dia $\phi 3\sim 10\text{mm}$ Shafts	
“Push-Through” Shafts		dia $\phi 8\text{mm}$ or Less	
Permissible Temp. & Humidity		0 ~ 40 °C, 80%	
Material		ABS and Aluminum	
Dimension & Weight		90 × 145 × h180mm, 4.5 kg	90 × 145 × h180mm, 5.3 kg
Packing Size & Gross Weight		320 × 300 × h180mm, 5 kg	320 × 300 × h180mm, 8 kg
Power Consumption		85 W	130 W
Electrical Reqts.		1 Phase, AC 120 V, 60 Hz or AC 230 V, 50 / 60 Hz	

Unit-only

Cat. No.	230V	DH.WOS01015	DH.WOS01025
	120V	DH.WOS02015	DH.WOS02025
Price, Each. ₩			

Digital Package-set (with ① Stirrer Unit, ② Impeller, ③ Clamp, ④ Stand)

Cat. No.	230V	DH.WOS01016	DH.WOS01026
	120V	DH.WOS02016	DH.WOS02026
Price, Each. ₩			

II. Digital Remote Controlled-type “HS-T”

Spec.	Model	(A) “HS-30T”	(B) “HS-100T”
		Max. Stirring Capa. 10 Lit	Max. Stirring Capa. 20 Lit
Maximum Viscosity / Torque		5,000 mPas / 70 Ncm	10,000 mPas / 80 Ncm
Speed Range & Motor		200 ~ 3,000 rpm, Direct Driven DC Motor	
Motor Rating (Input / Output)		83 / 75 W	130 / 120 W
Timer & Alarm		99hr 59min (with Continuous run.), Timer-end Alarm	
Controller / Display		Digital Feedback Controller / Digital LCD with Back-Light Function	
Chuck Grip Capa. ϕ mm		dia $\phi 3\sim 10\text{mm}$ Shafts	
“Push-Through” Shafts		dia $\phi 8\text{mm}$ or Less	
Permissible Temp. & Humidity		0 ~ 40 °C, 80%	
Safety Device / Material		Overload & Heat Protector for motor / ABS and Aluminum	
Dimension & Weight*		90 × 100 × h180mm, 3 kg	90 × 100 × h180mm, 3.8 kg
Packing Size & Gross Weight		580 × 340 × h230mm, 5 kg	580 × 340 × h230mm, 8 kg
Power Consumption		75 W	120 W
Electrical Reqts.		1 Phase, AC 120 V, 60 Hz or AC 230 V, 50 / 60 Hz	

Unit & Remote Controller

Cat. No.	230V	DH.WOS01035	DH.WOS01045
	120V	DH.WOS02035	DH.WOS02045
Price, Each. ₩			

Remote Package-set (with ① Stirrer Unit + Remote Controller, ② Impeller, ③ Clamp, ④ Stand)

Cat. No.	230V	DH.WOS01036	DH.WOS01046
	120V	DH.WOS02036	DH.WOS02046
Price, Each. ₩			

* Weight of Remote Controller = 2.5kg ** Other Specifications are available upon Customer’s Request.

- * “HS-30D(30T)” Package-set : Complete with ① “HS-30D(30T)” Stirrer Unit (with Remote Controller), ② “S721” Stainless-steel Impeller(Rod $\phi 8 \times L500\text{mm}$, 3-Blade $\phi 50\text{mm}$), ③ “CL200” Clamp, and ④ “ST110” Standard Plate Stand(Rod $\phi 16 \times L800\text{mm}$, Base w20 × d35cm)
- * “HS-100D(100T)” Package-set : Complete with ① “HS-100D(100T)” Stirrer Unit (with Remote Controller), ② “S723” Stainless-steel Impeller(Rod $\phi 8 \times L650\text{mm}$, 3-Blade $\phi 80\text{mm}$), ③ “CL200” Clamp, and ④ “ST120” Wide Plate Stand(Rod $\phi 23 \times L1,000\text{mm}$, Base w30 × d40cm)

DAIHAN® PREMIUM Hi-Torque Overhead Stirrer "OVS-T16", with Hi-Capacity BLDC-motor, Max. 14:1, 200,000mPas With Torque(Ncm)- / Viscosity(mPas)- / Temperature(°C)-Real Time Display, Optional Remote Control, Max. 2,000rpm **NEW**
 프리미엄 중/고점도용 교반기, 고사양 BLDC-motor, 토크- / 점도- / 온도-표시기능, "Push-Through" Shaft(φ 10mm or Less)



A. Max. 100Lit (H₂O) PREMIUM "OVS-T16" Unit Only



B. Max. 100Lit (H₂O) PREMIUM "OVS-T16" Package-set

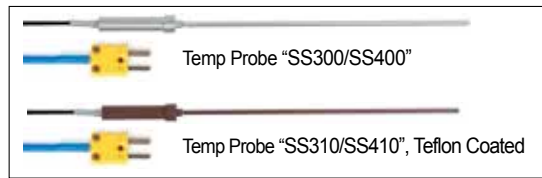

(1) Direct Contact Temp Probe, K-type (Optional)



(2) K-type PTFE Encapsulated Stainless-steel Thermocouple Probe (Optional)

- Made in Korea
- PL(Product Liability) Insurance
- Patented Jog Dial & Touch Button
- Hi-Capacity Brushless DC-motor : High Efficiency Stirring Performance and Precise Speed Control(Minimize RPM Fluctuation), Low Maintenance Cost
- Torque Value(Ncm)-/Viscosity(mPas)-/Temperature(°C) Real-time Display Can be used with K-type Temp. Probe for Temperature Display.
- Can be used with Optional Digital Remote Controller.
- "Push-Through" Shafts(φ10mm or Less) ; Ideal for Raising or Lowering the Stir-Shafts without Moving the Motor Head - "Adjustable Height of Shaft"
- with Certificate & Traceability : Controlled by Serial Number, Certificate, Delivery-information, and Traceable Data Base System
- * Ideal for Low-/Middle-Viscosity
- * Smooth Start and Change of the Stirring Speed.
- * Large Size Digital LCD Display

Specifications & Ordering information

Spec.	Model	"OVS-T16" Max. Torque 200,000mPas
Stirring Capacity		Max. 100 Lit (H ₂ O)
Maximum Viscosity / Torque		200,000 mPas / 700 Ncm
Speed Range & Motor		50~2,000RPM, Hi-Capacity Brushless DC-motor, Gear(2.6:1 / 14:1)
Motor Rating (Input / Output)		200 / 180W
Controller / Safety Device		Digital PID Control / Over Heat & Current Protector for Motor
Chuck Grip Capa. φ mm		dia φ6~10mm Shafts, Flex-Coupling(φ6~16mm)
"Push-Through" Shafts		dia φ10mm or Less
Permissible Temp. & Humidity		0 ~ 40°C, 80%
Dimension & Weight & Material		84 × 205 × h275mm, 3.5kg, Aluminum Die Casting
Power Consumption		250W
Electrical Reqts.		1 Phase, AC 120V, 60 Hz or AC 230 V, 50 / 60 Hz

* Other Specifications are available upon Customer's Request

A. Unit-only

Code	Description	Ea. Price, ₩
DH.Sti00016	Hi-Torque Overhead Stirrer Unit "OVS-T16", 230V	
DH.Sti00016.1	, 120V	

B. Package-set

- * Complete with ① "OVS-T16" Stirrer Unit
- ② "S732" Stainless-steel Impeller (Rod φ8 × L500mm, 4-Blade φ70mm)
- ③ "CL200" Clamp
- ④ "KA1177" Safety Stand (Rod φ23 × L800mm, Base 34 × 29cm)

Code	Description	Ea. Price, ₩
DH.Sti00116	Overhead Stirrer "OVS-T16" Package-set, 230V	
DH.Sti00116.1	, 120V	

C. Optional Digital Remote Controller, with Connecting Cable 1.5m

- * Assembly-type, Torque / Viscosity / Temp-Control & Display
- * Connecting Cable 1.5m(Included) and 2m(Optional)
- * Size : w75 × d150 × h30mm, Weight : 150g

Code	Description	Ea. Price, ₩
DH.WOS50010	Digital Remote Controller with 1.5m Connecting Cable & Plug	
DH.Cabl002	Optional Connecting Cable & Plug, 2m	

Optional Temperature Probes

(1) Direct Contact Temp Probe, K-type

Code	Description	Ea. Price, ₩
DH.WHP503040	Temp Probe, K-type, "SS300", L250 × φ 4.8 mm	
DH.WHP503050	, "SS400", L380 × φ 4.8 mm	
DH.WHP503041	Temp Probe, K-type, "SS310", Teflon Coated, L250 × φ 5 mm	
DH.WHP503051	, "SS410", Teflon Coated, L380 × φ 5 mm	

(2) K-type PTFE Encapsulated Stainless-steel Thermocouple Probe

※ Note! For the Optional Probe ⇒ See the "Measuring, Thermometer" Section
 For the Optional Impeller ⇒ See the "Stirrer, Accessory" Section

DAIHAN® **PREMIUM Ultra** Hi-Torque Overhead Stirrer "OVS-G30", with Hi-Capacity BLDC-motor, Max. 60:1 **NEW**
 With Planetary-gear, Torque(Ncm)- / Viscosity(mPas)- / Temperature(°C)-Real Time Display, Optional Remote Control
 프리미엄 초고점도용 교반기, 고사양 BLDC-motor, 토크- / 점도- / 온도-표시기능, Max. 550rpm, 350,000mPas



A. Max. 100Lit (H₂O) **PREMIUM Ultra** "OVS-G30" Unit Only



B. Max. 100Lit (H₂O) **PREMIUM Ultra** "OVS-G30" Package-set

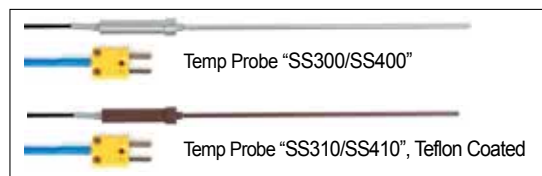

(1) Direct Contact Temp Probe, K-type (Optional)



(2) K-type PTFE Encapsulated Stainless-steel Thermocouple Probe (Optional)

- Made in Korea
- PL (Product Liability) Insurance
- Patented Jog Dial & Touch Button
- High Performance Brushless DC-motor : High Efficiency Stirring Performance and Precise Speed Control(Minimize RPM Fluctuation), Low Maintenance Cost
- Torque Value(Ncm)-/Viscosity(mPas)-/Temperature(°C) Real-time Display
Can be used with K-type Temp. Probe for Temperature Display.
- Excellent Planetary Gear Design for High Torque(60:1 Ratio)
- Can be used with Optional Wire Digital Remote Controller.
- with Certificate & Traceability : Controlled by Serial Number, Certificate, Delivery-information, and Traceable Data Base System
- * Ideal for Low-/Middle-Viscosity
- * Smooth Start and Change of the Stirring Speed.
- * Large Size Digital LCD Display

Specifications & Ordering information

Spec.	Model	"OVS-G30" Max. Torque 350,000mPas
Stirring Capacity		Max. 100 Lit (H ₂ O)
Maximum Viscosity / Torque		350,000 mPas / 800 Ncm
Speed Range & Motor		10~550RPM, Hi-Capacity Brushless DC-motor, Gear(11:1 / 60:1)
Motor Rating (Input / Output)		200 / 180W
Controller / Safety Device		Digital PID Control / Over Heat & Current Protector for Motor
Chuck Grip Capa. φmm		dia φ6~10mm Shafts, Flex-Coupling(φ6~16mm)
Permissible Temp. & Humidity		0 ~ 40 °C, 80%
Dimension & Weight & Material		84×205×h355mm, 3.5kg, Aluminum Die Casting
Power Consumption		250W
Electrical Reqts.		1 Phase, AC 120V, 60 Hz or AC 230 V, 50 / 60 Hz

* Other Specifications are available upon Customer's Request

A. Unit-only

DH.StiO0030	Ultra Hi-Torque Overhead Stirrer Unit "OVS-G30", 230V	Ea. Price, ₩
DH.StiO0030.1	, 120V	

B. Package-set

- * Complete with ① "OVS-G30" Stirrer Unit
- ② "S732" Stainless-steel Impeller (Rod φ8×L500mm, 4-Blade φ70mm)
- ③ "CL200" Clamp
- ④ "KA1177" Safety Stand (Rod φ23×L800mm, Base 34×29cm)

DH.StiO0130	Overhead Stirrer "OVS-G30" Package-set, 230V	Ea. Price, ₩
DH.StiO0130.1	, 120V	

C. Optional Digital Remote Controller, with Connecting Cable 1.5m

- * Assembly-type, Torque / Viscosity / Temp-Control & Display
- * Connecting Cable 1.5m(Included) and 2m(Optional)
- * Size : w75×d150×h30mm, Weight : 150g

DH.WOS50010	Digital Remote Controller with 1.5m Connecting Cable & Plug	Ea. Price, ₩
DH.Cabi002	Optional Connecting Cable & Plug, 2m	

Optional Temperature Probes

(1) Direct Contact Temp Probe, K-type

DH.WHP503040	Temp Probe, K-type, "SS300", L250×φ 4.8 mm	Ea. Price, ₩
DH.WHP503050	, "SS400", L380×φ 4.8 mm	
DH.WHP503041	Temp Probe, K-type, "SS310", Teflon Coated, L250×φ 5 mm	
DH.WHP503051	, "SS410", Teflon Coated, L380×φ 5 mm	

(2) K-type PTFE Encapsulated Stainless-steel Thermocouple Probe

※ Note! For the Optional Probe ⇒ See the "Measuring, Thermometer" Section
 For the Optional Impeller ⇒ See the "Stirrer, Accessory" Section

DAIHAN® High-Torque Overhead Stirrer “HT-AX” & “HT-DX”, for Middle-/High-Viscosity, Max.40 · 60Lit, 60,000 · 90,000mPas With “Push-Through” Shaft(φ 10mm or Less) and Chuck grip φ 6~12mm, Flex-Coupling φ 6~16mm, Max.1,000rpm
중/고점도용 강력교반기, 사용교반봉; ①기본은 φ 6~12mm, ②관통은 φ 6~10mm, & ③별도의 Flex-Coupling 활용시 φ 6~16mm



(III-B) Max. 60Lit Analog “HT-120AX” Package-set



(IV-B) Max. 60Lit Digital “HT-120DX” Package-set



(II-B) HT-120DX

- Made in Korea
- CE Certified
- PL (Product Liability) Insurance
- Ensure Minimize RPM Fluctuation : Very Stable Stirring Speed(RPM) Performance
- * with Certificate & Traceability : Controlled by Serial Number, Certificate, Delivery-information, and Traceable Data Base System
- * 3.5:1 Ratio Worm-gear Motor
- * “Push-Through” Shafts(φ 10mm or Less) ; Ideal for Raising or Lowering of the Stir-Shafts without Moving the Motor Head - “Adjustable Height of Shaft”

I. Analog Control Stirrer “HT-AX”

- * Easy-to-use Dial for Speed Setting
- * Speed Range : 50 ~ 1,000 rpm
- * Smooth Start and Change of the Stirring Speed

II. Digital Control Stirrer “HT-DX”

- Patented Jog-Shuttle Control System
- * Digital LCD with Back-Light Function
- * Speed Range : 50 ~ 1,000 rpm, Control and Display by 1 rpm
- * Timer : 99hr 59min (with Continuous run), Error status & Timer-end Alarm

III. Analog Stirrer Package-set

- * III-A. “HT-50AX” Set : Complete with ① “HT-50AX” Stirrer Unit, ② “S732” Stainless-steel Impeller(Rod φ 8×L500mm, 4-Blade φ 70mm), ③ “CL200” Clamp, and ④ “KA1177” Safety Stand(Rod φ 23×L800mm, Base w34×d29cm)
- * III-B. “HT-120AX” Set : Complete with ① “HT-120AX” Stirrer Unit, ② “S736” Stainless-steel Impeller(Rod φ 10×L650mm, 4-Blade φ 90mm), ③ “CL200” Clamp, and ④ “KA1177” Safety Stand(Rod φ 23×L800mm, Base w34×d29cm)

IV. Digital Stirrer Package-set

- * IV-A. “HT-50DX” Set : Complete with ① “HT-50DX” Stirrer Unit, ② “S732” Stainless-steel Impeller (Rod φ 8×L500mm, 4-Blade φ 70mm), ③ “CL200” Clamp, and ④ “ST120” Wide Plate Stand (Rod φ 23×L1000mm, Base w30×d40cm)
- * IV-B. “HT-120DX” Set : Complete with ① “HT-120DX” Stirrer Unit, ② “S736” Stainless-steel Impeller (Rod φ 10×L650mm, 4-Blade φ 90mm), ③ “CL200” Clamp, and ④ “ST200” Deluxe Safety Stand (Rod φ 23×L1200mm, Base w39×up to 75cm)

Specifications & Ordering information

Spec.	Model	A. Max. Stirring Capa. 40Lit	B. Max. Stirring Capa. 60 Lit
		(I-A) Analog “HT-50AX” (II-A) Digital “HT-50DX”	(I-B) Analog “HT-120AX” (II-B) Digital “HT-120DX”
Stirring Capacity		Max. 40 Lit (H ₂ O)	Max. 60 Lit (H ₂ O)
Maximum Viscosity / Torque		60,000 mPas / 180 Ncm	90,000 mPas / 210 Ncm
Motor		Worm-Geared DC Motor (3.5:1 Ratio)	
Motor Rating (Input / Output)		83 / 75 W	130 / 120 W
Chuck Grip Capa. φ mm		dia φ 6~12mm Shafts	
“Push-Through” Shafts		dia φ 10mm or Less	
Permissible Temp. & Humidity		0 ~ 40℃, 80%	
Safety Device / Material		Overload & Heat Protector for Motor / ABS and Aluminum	
Dimension & Weight		90×180×h130mm, 3.5 kg	90×210×h130mm, 4 kg
Packing Size & Gross Weight		320×300×h180mm, 5 kg	320×300×h180mm, 8 kg
Power Consumption		85 W	130 W
Electrical Reqt.s.		1 Phase, AC 120 V, 60 Hz or AC 230 V, 50 / 60 Hz	

I. Analog Stirrer Only		(I-A) “HT-50AX”	(I-B) “HT-120AX”
Cat. No.	230V	DH.WOS01251	DH.WOS01271
	120V	DH.WOS02251	DH.WOS02271
Price, Each. ₩			
II. Digital Stirrer Only		(II-A) “HT-50DX”	(II-B) “HT-120DX”
Cat. No.	230V	DH.WOS01051	DH.WOS01071
	120V	DH.WOS02051	DH.WOS02071
Price, Each. ₩			
III. Analog Package Set		(III-A) “HT-50AX” Set	(III-B) “HT-120AX” Set
Cat. No.	230V	DH.WOS01252	DH.WOS01272
	120V	DH.WOS02252	DH.WOS02272
Price, Each. ₩			
IV. Digital Package Set		(IV-A) “HT-50DX” Set	(IV-B) “HT-120DX” Set
Cat. No.	230V	DH.WOS01052	DH.WOS01072
	120V	DH.WOS02052	DH.WOS02072
Price, Each. ₩			

* Other Specifications are available upon Customer's Request.

DAIHAN® Remote Control High-Torque Digital Overhead Stirrer “HTT”, for Middle-/High-Viscosity, Max.40 · 60 · 100Lit With “Push-Through” Shaft(φ 10mm or Less) and Chuck grip φ6~12mm, Flex-Coupling φ6~16mm, 120,000mPas, Max.1,000rpm
 원격조절식 디지털 중/고점도용 강력교반기, 사용교반봉; ①기본은 φ6~12mm, ②관통은 φ6~10mm, & ③별도의 Flex-Coupling 활용시 φ8~16mm



Digital High-Torque Overhead Stirrer with Stirring Speed Remote Controller “HT-120T” Package-Set



“HT-140T” Digital High-Torque Overhead Stirrer (included Stirring Speed Remote Controller and Temp. Display) in Modular Reactor System

- Made in Korea
- CE Certified
- PL(Product Liability) Insurance
- Ensure Minimize RPM Fluctuation : Very Stable Stirring Speed(RPM) Performance
- with Certificate & Traceability : Controlled by Serial Number, Certificate, Delivery-information, and Traceable Data Base System
- Patented Jog-Shuttle Control System

* “Push-Through” Shafts(φ 10mm or Less) ; Ideal for Raising or Lowering of the Stir-Shafts without Moving the Motor Head - “Adjustable Height of Shaft”
 * Included Remote-type Digital Feedback Controller :
 - “HT-50T”, “HT-120T” model : Included Stirring-speed Remote Controller
 - “HT-140T” model : Ideal for Reaction System.
 Included Stirring-speed Control and Temperature Display Remote Controller for Reactor Module.

Specifications & Ordering information

Spec.	Model	“HT-50T” Max. Stirring Capa. 40L	“HT-120T” Max. Stirring Capa. 60L	“HT-140T” Max. Stirring Capa. 100L
Stirring Capacity(H ₂ O)		Max. 40 Lit	Max. 60 Lit	Max. 100 Lit
Maximum Viscosity / Torque		60,000 mPas / 180 Ncm	90,000 mPas / 210 Ncm	120,000 mPas / 300 Ncm
Speed Range & Motor		50 ~ 1,000 rpm Worm-Geared Motor(3.5:1 Ratio)		50 ~ 800 rpm
Motor Rating (Input / Output)		83 / 75 W	130 / 120 W	
Timer & Alarm		99hr 59min (with Continuous run.), Timer-end Alarm		
Controller / Display		Digital Feedback Remote Controller / Digital LCD with Back-Light Function		Stirring Speed & Temp. Display Remote Controller
Max. Impeller Shaft Diameter		φ 10 mm		
Permissible Temp. & Humidity		0 ~ 40℃, 80%		
Safety Device		Overload & Heat Protector for motor		
Material		ABS and Aluminum		
Dimension & Weight*		155×180×h110mm, 3.5 kg	155×230×h110mm, 4 kg	
Packing Size & Gross Weight		580×340×h230mm, 5 kg	580×340×h230mm, 8 kg	
Power Consumption		75 W	120 W	
Electrical Reqts.		1 Phase, AC 120 V, 60 Hz or AC 230 V, 50 / 60 Hz		

Unit & Remote Controller

Cat. No.	230V	DH.WOS01065	DH.WOS01075	DH.WOS01085
	120V	DH.WOS02065	DH.WOS02075	DH.WOS02085
Price, Each. ₩				
Package-set (with ① Stirrer+Remote Controller, ② Impeller, ③ Clamp, ④ Stand)				
Cat. No.	230V	DH.WOS01066	DH.WOS01076	-
	120V	DH.WOS02066	DH.WOS02076	-
Price, Each. ₩				

* Weight of Remote Controller = 2.5kg ** Other Specifications are available upon Customer's Request.

- * “HT-50T” Package-set : Complete with ① “HT-50T” Stirrer Unit with Remote Controller ② “S732” Stainless-steel Impeller (Rod φ8×L500mm, 4-Blade φ70mm) ③ “CL200” Clamp, and ④ “ST120” Wide Plate Stand(Rod φ23×L1000mm, Base w30×d40cm)
- * “HT-120T” Package-set : Complete with ① “HT-120T” Stirrer Unit with Remote Controller ② “S736” Stainless-steel Impeller (Rod φ10×L650mm, 4-Blade φ90mm) ③ “CL200” Clamp, and ④ “ST200” Deluxe Safety Stand (Rod φ23× L1,200mm, Base 39× up to 75cm)

※ Details of Wide-Range Coupling : See the “Stirrer Accessory”

DAIHAN® Digital Jar Tester “JT-M6C”, 6-Paddle Stirrer for Flocculation Test, 300 rpm, with Certi. & Traceability
 With Programmable Digital Feedback Control, 6 Impellers, 6 Independent Light Source, up to 6 × 1Lit Beakers
 프로그램/디지털 자 테스트, 정밀 직류 기어드 모터와 특화된 타이밍벨트, 디지털 피드백 컨트롤



- Made in Korea ■ CE Certified ■ PL(Product Liability) Insurance
- with Certificate & Traceability : Controlled by Serial Number, Certificate, Delivery-information, and Traceable Data Base System
- Ideal for Flocculation Testing in Water Treatment Laboratories
- 6 Independent Light Source for Each Stirring Point
- * Deciding on Coagulant Chemistries * Digital Display for RPM, Power Bar-Graph and Status
- * Digital Feedback Control using Microprocessor : Stable and Accurate Stirring Speed
- * Geared DC Motor and Specially Designed Timing Belt used
- * Stable and Accurate Stirring Speed by Feedback Control
- * Digital LCD with Back-Light Function * Programmable Operation : 10 Steps, 6 Programs

Specifications & Ordering information

Spec.	Model	“JT -M6C”
6 × Paddler (Stainless steel Shaft)		φ8 × L400mm
		Straight Blade w75 × h25mm
Stirring Capacity		6 × 1 Liter Beaker
Motor & Power		Geared DC Motor with Timing Belt (10:1 ratio), 40W
Speed & Accuracy		20~300 rpm, ± 5 rpm
Timer		99hr 59min 59sec (Programmable)
Display		Digital LCD with Back-Light for RPM, Power Bar-Graph and Status
Controller		Programmable Digital Feedback Controller with Jog-Shuttle Switch (Turn + Push)
Program Function		10 Steps, 6 Programs, and Storage for Set Values : RPM and Timer
Florescent Lamp		20W × 6 (Independent Light Source for Each Sample)
Dimension (w × d × h) (mm)		1,000 × 310 × 535
Safety Device		Overload & Over Heat Protector for motor
Others		PL(Product Liability) Insurance and Storage Function (RPM, Timer)
Packing and Gross Weight		1,120 × 430 × h740mm, 69 kg
Electrical Reqts.		1 Phase, AC 120 V, 60 Hz or AC 230 V, 50 / 60 Hz

Cat. No.	230V	DH.WJT06020	
Price, Each. ₩	120V	DH.WJT06021	

※ 운임 약 ₩ 18,000 별도!



Geared DC Motor with Special Timing Belt

Stirrer, Accessory



SciLab® DURAN glass Stirring Rod, with Round Ends, φ7 ~ φ10, L200 ~ 650mm
 Borosilicate Glass α 3.3, 글라스핸디 교반봉, 끝부분이 둥근모양, 긁힘방지

- Made of DURAN® Glass Rod : by SciLab Korea. * Rounded Ends for Extra Safety * Non-Scratching

(1) L200~350mm Length

SL.StiS201	Glass Rod, φ7, L200mm	Ea. Price, ₩
SL.StiS202	, L250mm	
SL.StiS203	, L300mm	
SL.StiS204	Glass Rod, φ8, L300mm	Ea. Price, ₩
SL.StiS205	, L350mm	

(2) L400~650mm Length

SL.StiS206	Glass Rod, φ8, L400mm	Ea. Price, ₩
SL.StiS207	, L500mm	
SL.StiS208	Glass Rod, φ10, L450mm	Ea. Price, ₩
SL.StiS209	, L500mm	
SL.StiS210	, L650mm	



SciLab® DURAN glass Double-ended Stirring Rod, φ6 ~ φ10mm, L200 ~ L500mm
 Useful for Crushing Clumped Powder and Solids, Borosilicate Glass α 3.3

- Made of DURAN® Borosilicate Glass 3.3 Rod : by SciLab Korea.

- * With Rounded Button and Paddle Ends for Extra Safety and to Minimize Scratching
- * Button End is Useful for Crushing Clumped Powder and Solids

(1) L200~300mm Length

SL.StiS211	2-end Rod, φ6, L200mm	Ea. Price, ₩
SL.StiS212	, L250mm	
SL.StiS213	, L300mm	
SL.StiS214	2-end Rod, φ9, L300mm	Ea. Price, ₩

(2) L350~500mm Length

SL.StiS215	2-end Rod, φ9, L350mm	Ea. Price, ₩
SL.StiS216	, L400mm	
SL.StiS217	2-end Rod, φ10, L450mm	Ea. Price, ₩
SL.StiS218	, L500mm	

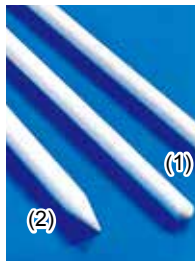
Articles	Cat. No	Description
		Cowie® PTFE Handy Stirring Rod, with Steel-core or Solid PTFE, ϕ 6/8 × L200~400mm With Steel-core or Solid PTFE, -200°C ~ +280°C, Teflon 핸디 교반봉
■ Made in U.K. * Can be Bent into a Permanent Shape		
(1) With PTFE/Steel Core	Ea. Price, ₩	(2) With Solid PTFE, Tapered End
CW.003.250 PTFE/Steel Rod, ϕ 6 × L250 mm		CW.003.1200 PTFE Rod, ϕ 8 × L200 mm
CW.003.300 , ϕ 6 × L300 mm		CW.003.1250 , ϕ 8 × L250 mm
CW.003.350 , ϕ 6 × L350 mm		CW.003.1300 , ϕ 8 × L300 mm
CW.003.400 , ϕ 6 × L400 mm		

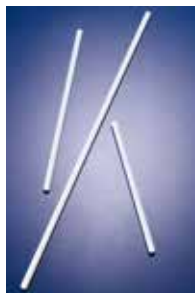
		Azlon® PTFE Handy Stirring Rods, ϕ 6mm, L150~400mm With Steel-Core, Heat/Corrosion Resistance, -200°C ~ +260°C, PTFE 핸디 교반봉
■ Made in U.K. * Suitable for Stirring Even the Most Corrosive Liquids * Will Withstand 260°C * PTFE Covered with Plain Ends * 6mm Diameter		
Az.SWN542 PTFE/Steel Rod, ϕ 6 × L150 mm	Ea. Price, ₩	Az.SWN548 PTFE/Steel Rod, ϕ 6 × L300 mm
Az.SWN544 , ϕ 6 × L200 mm		Az.SWN550 , ϕ 6 × L350 mm
Az.SWN546 , ϕ 6 × L250 mm		Az.SWN552 , ϕ 6 × L400 mm

		PP T-shaped & Triangle- Stirring Rod/Cell Spreader, Sterile, L140 & 215mm NEW Made of Polypropylene(PP), Blue Color, Individually Packed, 멸균 삼각- & T-교반봉/셀 스프레더
■ Supplied by ABDOS® in India * Made of Polypropylene(PP), Autoclavable at 121°C * Designed to Spread and Disperse Liquid onto the Surface of an Agar-plate without Gouging or Cutting the Medium * Individually Wrapped Package * Sterilized according to EN ISO 11137-2		
DH.Spr3001 Spreader, PP, Total-L140mm, Blade width × 35mm, T-shaped	Ea. Price, ₩	Cs. Price, ₩
DH.Spr3003 -L215mm, Blade width × 30mm, Triangle-shaped		100ea 400ea

		Stainless-steel Stirring Rod/Cell Spreader, L165/242mm NEW For Bacteriological Applications, Autoclavable, 삼각 교반봉/셀 스프레더, 다용도
■ Supplied by SciLab Korea * Smooth Triangular ends for Smooth Spreading * Ideal for Spreading and Dispersing, Distribution of Bacterial Substances on Solid Nutrient Media		
SL.Spr7001 Cell Spreader/Stirring Rod, STS, L165 × Blade width 35mm	Ea. Price, ₩	
SL.Spr7002 , L165 × Blade width 45mm		
SL.Spr7003 , L200 × Blade width 30mm		

		Hammacher® Hi-grade Stainless-steel Stirring Rod/Cell Spreader, L195/150mm For Bacteriological Applications, 삼각 교반봉/셀스프레더/Prigalski-스패출러 겸용, 다용도
■ Made in Germany * For even Spreading, Better Distribution Across Media, or Mixing Different Liquids * Made of Wironit™, 18/12 Stainless-steel (STS), Anti-magnetic, Rustless, Acid resistant, MP 1,400°C		
HA.HWN072.19 Cell Spreader/Stirring Rod, STS, L195 × Blade width 35mm	Ea. Price, ₩	
HA.HWN074.15 , L150 × Blade width 25mm		

		SciLab® DURAN glass Stir-Guide Set, for 50~10000ml Stirring Glass, 유리 교반봉 셋트
■ Made of Original DURAN® Borosilicate Glass 3.3 : by SciLab Korea. * with PTFE Blade/Impeller * Stir-Guide : od. ϕ 15 × id. ϕ 10mm, internal Ground * Shaft / Rod : ϕ 10mm Ground.		
(1) General-type	Ea. Price, ₩	
SL.StiS221 for-50 ~ 500 ml , L : 400 mm, ₩24/40, Blade w52 × h14 mm		
SL.StiS222 -500 ~ 5000 ml , L : 450 mm, ₩24/40, Blade w76 × h19 mm		
SL.StiS223 -500 ~ 5000 ml , L : 450 mm, ₩34/45, Blade w75 × h25 mm		
SL.StiS224 -2000 ~ 10000 ml, L : 500 mm, ₩45/50, Blade w125 × h25 mm		
(2) Water Cooled-type	Ea. Price, ₩	
SL.StiS226 for-500 ~ 5000 ml , L : 450 mm, ₩24/40, Blade w76 × h19 mm		
SL.StiS227 -500 ~ 5000 ml , L : 450 mm, ₩34/45, Blade w75 × h25 mm		
SL.StiS228 -2000 ~ 10000 ml, L : 500 mm, ₩45/50, Blade w125 × h25 mm		
Spare ₩ Stirrer-Guide(Seal), with Internal Ground ϕ 10mm	Ea. Price, ₩	
SL.StiS231 Stir-Guide, id ϕ 10 × 2.5mm, ₩24/40		
SL.StiS232 , ₩29/42		
SL.StiS233 , ₩34/45		



SciLab® DURAN glass Lubri-Stir-Guide/Seal, for $\phi 8$ & $\phi 10$ mm shafts, ₩24/40 & ₩34/45
With Red PBT Opentop Screwcap & PTFE/Silicone O-ring Seal, 루부리 스티러 씰

■ **Made of Original DURAN® PBT Screw Seal Kit / Borosilicate Glass 3.3 : by SciLab Korea**

* The Cup : To Accept a Suitable Sealing Lubricants <Ex.> : Glycerol, Liquid Paraffin, Spindle Oil, etc.

(1) for $\phi 8$ mm Stir-Shaft

SL.StiS235 Lubri-Stir-Guide, for $\phi 8$ mm Rod, GL18, ₩24/40
SL.StiS236 , GL25, ₩34/45

Ea.	Price, ₩

(2) for $\phi 10$ mm Stir-Shaft

SL.StiS237 Lubri-Stir-Guide, for $\phi 10$ mm Rod, GL18, ₩24/40
SL.StiS238 , GL25, ₩34/45

Ea.	Price, ₩

SciLab® Vacuum Stirrer-Guide, with DURAN® PBT Opentop Cap & PTFE/ Silicone O-Ring Seal and ₩24/- ~ 45/-Glass joints
For $\phi 8$ ~14mm Shafts, with Red PBT Screw Grip System, Chemically Inert, 200°C Stable, 스크류 스티러 씰

■ **Made of DURAN® Borosilicate Glass α 3.3 and Seal Kit with PBT GL-Opentop Screwcap / PTFE-Silicone O-Ring Seal : by SciLab Korea.**



(1) with ASTM ₩24/40 ~ 45/50 Joints

SL.StiS241 for $\phi 8$ mm Rod , GL25, 24/40
SL.StiS242 , 29/42
SL.StiS243 , 34/45
SL.StiS245 for $\phi 10$ mm Rod, GL25, 24/40
SL.StiS246 , 29/42
SL.StiS247 , GL32, 34/45
SL.StiS251 for $\phi 12$ mm Rod, GL32, 34/45
SL.StiS252 , 45/50
SL.StiS253 for $\phi 14$ mm Rod, GL32, 34/45
SL.StiS254 , 45/50

Ea.	Price, ₩

(2) with DIN ₩24/29 ~ 45/40 Joints

SL.StiS241D for $\phi 8$ mm Rod , GL25, 24/29
SL.StiS242D , 29/32
SL.StiS243D , 34/35
SL.StiS245D for $\phi 10$ mm Rod, GL25, 24/29
SL.StiS246D , 29/32
SL.StiS247D , GL32, 34/35
SL.StiS251D for $\phi 12$ mm Rod, GL32, 34/35
SL.StiS252D , 45/40
SL.StiS253D for $\phi 14$ mm Rod, GL32, 34/35
SL.StiS254D , 45/40

Ea.	Price, ₩

SciLab® PTFE Stirrer-Guide/Seal, for $\phi 8$ ~ $\phi 14$ mm Shafts, with ₩24/-, ₩29/-, and ₩34/-Joints
With 2 Bearings / Screw-Retainer / Viton O-ring, All PTFE, -180~+260°C Stable, PTFE 스티러 씰

■ **Made in Korea** ■ **Common-use : to ASTM & DIN-type Socket Joints**



(1) for $\phi 8$ mm Stir-Shaft

SL.Ada405 for $\phi 8$ mm Rod, ₩24/40
SL.Ada406 , ₩29/42
SL.Ada407 , ₩34/45

Ea.	Price, ₩

(2) for $\phi 10$ mm Stir-Shaft

SL.Ada409 for $\phi 10$ mm Rod, ₩24/40
SL.Ada410 , ₩29/42
SL.Ada411 , ₩34/45

Ea.	Price, ₩

(3) for $\phi 12$ & 14mm Stir-Shaft

SL.Ada413 PTFE Stir-Guide, for $\phi 12$ mm Rod, ₩34/45
SL.Ada415 , for $\phi 14$ mm Rod, ₩34/45

Ea.	Price, ₩

₩ Joint-Screw-NPT-PTFE/PEEK High-class Vacuum Stirrer Guide, with ASTM/DIN ₩ Glass Cone Joint, for $\phi 8$ ~16mm Shaft
Ideal for Middle/Low-Vacuum, 500/800rpm, Chemically Inert, -200°C ~ +280°C Stable, 고품질 진공 ₩ 교반 씰

■ **Made of UK.** ■ **Suitable for Glass Same Size Socket of ASTM or DIN**

* PTFE in the only Media Contact Material

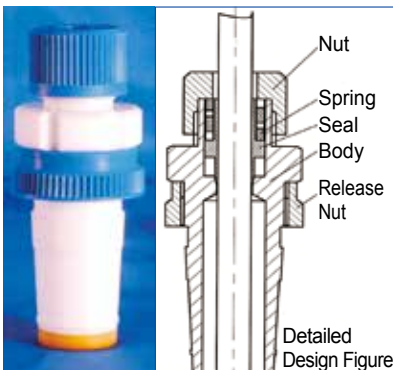

for Low/Middle Vacuum/Pressure

(1) for ASTM Socket Joint Sizes ; for $\phi 8$ ~16mm Shaft

CW.005.0.0824 Stirrer Seal, USA-type, for- $\phi 8$ mm Shafts, ₩24/40 Joint
CW.005.0.1024 - $\phi 10$ mm Shafts, ₩24/40 Joint
CW.005.0.1034 - $\phi 10$ mm Shafts, ₩34/45 Joint
CW.005.0.1434 - $\phi 14$ mm Shafts, ₩34/45 Joint
CW.005.0.1634 - $\phi 16$ mm Shafts, ₩34/45 Joint

Ea.	Price, ₩

(2) for DIN/ISO Socket Joint Sizes ; for $\phi 8$ ~16mm Shaft

CW.005.00.0824 Stirrer Seal, EUROPE-type, for- $\phi 8$ mm Shafts, ₩24/29 Joint
CW.005.00.1029 - $\phi 10$ mm Shafts, ₩29/32 Joint
CW.005.00.1045 - $\phi 10$ mm Shafts, ₩45/40 Joint
CW.005.00.1434 - $\phi 14$ mm Shafts, ₩34/35 Joint
CW.005.00.1645 - $\phi 16$ mm Shafts, ₩45/40 Joint

Ea.	Price, ₩

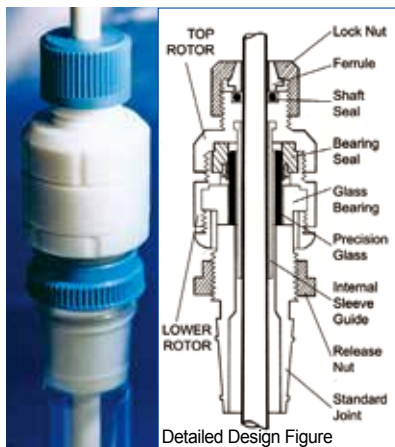

Detailed Design Figure
for High Vacuum / Pressure

Cowie® High-Vacuum / Pressure Stirrer Guide, PTFE/PEEK/Glass-Bearing Seal
For $\phi 8\sim 16$ mm Shafts, Useable up to 800rpm, 280°C Stable, 고진공/압력용 교반 실편

■ Made in U.K. ■ High Vacuum 5mmHg & Pressure 3~5psi Performance

* Anti-Whip, Reduced Vibration, No-Shedding, Self-Releasing Joint Ring, Totally Inert.
* Specially Fabricated Glass Ball-Bearing & PTFE/PEEK Seal : Useable up to 800rpm

(1) for ASTM Socket Joint Sizes ; for $\phi 8\sim 16$ mm Shafts

CW.005.1047	Stirrer Seal, USA-type, for- ϕ 8mm Shafts, ₩24/40 Joint
CW.005.1057	- ϕ 10mm Shafts, ₩24/40 Joint
CW.005.1067	- ϕ 10mm Shafts, ₩29/42 Joint
CW.005.1097	- ϕ 14mm Shafts, ₩34/45 Joint
CW.005.1117	- ϕ 16mm Shafts, ₩34/45 Joint

Ea.	Price, ₩

(2) for DIN/ISO Socket Joint Sizes ; for $\phi 10\sim 16$ mm Shafts

CW.005.2067	Stirrer Seal, EUROPE-type, for- ϕ 10mm Shafts, ₩29/32 Joint
CW.005.2077	- ϕ 10mm Shafts, ₩34/35 Joint
CW.005.2097	- ϕ 14mm Shafts, ₩34/35 Joint
CW.005.2127	- ϕ 16mm Shafts, ₩45/40 Joint

Ea.	Price, ₩

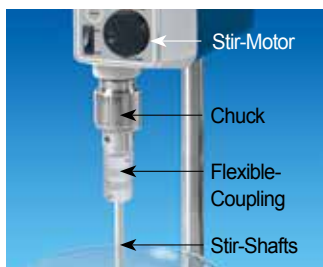

Flexible Coupling, for Safety Stirring of $\phi 6\sim 16$ mm Shafts of Overhead Stirrers
For Stirrers between Stirring Motor and Shaft, 안전교반용 유연성 커플링

■ Used to Compensate Any Vibrations Between The Motor and Stirring Shafts

* Made in Korea * Shaft Fastening by Screw Clamp Band * Made of DURALUMIN
* with Exchangeable STS Chucking Rod $\phi 8 / 10 / 12$ mm, L40mm

(1) UTILITY High-Flex. Metal Coupling, with 2 X Flex-band, for $\phi 6\sim 16$ mm Stir-Shafts
Ideal for Low/High Viscosity and High/Low Speed

SL.StiC011	Stir-Coupling, Hi-flex, $\phi 8$ mm Chuck-rod , for- $\phi 6$ mm Stir-Shaft , 56g , $\phi 25 \times h44$ mm
SL.StiC012	- $\phi 8$ mm Stir-Shaft , 53g , $\phi 25 \times h44$ mm
SL.StiC013	- $\phi 10$ mm Stir-Shaft, 49g , $\phi 25 \times h44$ mm
SL.StiC014	Stir-Coupling, Hi-flex, $\phi 10$ mm Chuck-rod, for- $\phi 8$ mm Stir-Shaft , 49g , $\phi 25 \times h44$ mm
SL.StiC015	- $\phi 10$ mm Stir-Shaft, 43g , $\phi 25 \times h44$ mm
SL.StiC016	- $\phi 12$ mm Stir-Shaft, 33g , $\phi 25 \times h44$ mm
SL.StiC017	Stir-Coupling, Hi-flex, $\phi 12$ mm Chuck-rod, for- $\phi 10$ mm Stir-Shaft, 33g , $\phi 25 \times h44$ mm
SL.StiC018	- $\phi 12$ mm Stir-Shaft, 123g, $\phi 32 \times h60$ mm
SL.StiC019	- $\phi 14$ mm Stir-Shaft, 120g, $\phi 32 \times h60$ mm
SL.StiC020	- $\phi 16$ mm Stir-Shaft, 118g, $\phi 32 \times h60$ mm

Ea.	Price, ₩

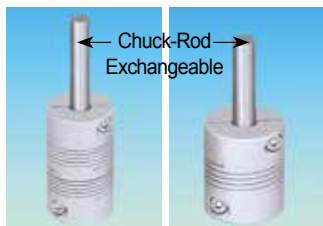

(1) Hi-flex Metal ; (2) Heavy-duty Metal
for $\phi 6\sim 16$ Shafts; for $\phi 10\sim 16$ Shafts

(2) Heavy-duty Metal Coupling, with Short Flex-band, for $\phi 10\sim 16$ mm Stir-Shafts
Low-Flexible type, Ideal for High Viscosity and Middle/Low Speed

SL.StiC023	Stir-Coupling, Low-flex, $\phi 10$ mm Chuck rod, for- $\phi 10$ mm Stir-Shafts, 45g , $\phi 25 \times h30$
SL.StiC024	- $\phi 12$ mm Stir-Shafts, , $\phi 25 \times h30$
SL.StiC025	Stir-Coupling, Low-flex, $\phi 12$ mm Chuck rod, for- $\phi 12$ mm Stir-Shafts, 105g, $\phi 32 \times h38$
SL.StiC026	- $\phi 14$ mm Stir-Shafts, , $\phi 32 \times h38$
SL.StiC027	- $\phi 16$ mm Stir-Shafts, , $\phi 32 \times h38$

Ea.	Price, ₩



(3) Rubber Based for $\phi 7\sim 10$ Shafts

(3) Very Flexible Rubber Based Coupling, for $\phi 7\sim 10$ mm Shafts
Especially, Ideal for GLASS Shafts and Low/Middle Viscosity & High Speed

* Made in Germany * Shaft Fastening by Screw Compression Rubber Ring Pad.
* with $\phi 10 \times L40$ mm Exchangeable Stainless-steel Chucking Rod

WI.1445000 Stir-Coupling, Rubber Based, for $\phi 7\sim \phi 10$ mm Shafts, 72.5g, Body $\phi 46 \times h80$ mm

Ea.	Price, ₩

SciLab® Stainless-steel Stirring Shaft, for Lab & Industrial Overhead Stirrers, Rod $\phi 8\sim 12 \times L500\sim 1000$ mm
Ideal for Universal-use of Wide-range Speed & Viscosity, 스테인레스 교반봉 / 임펠러



(1) 3-bladed Propeller-type
Universal-use

■ Made in Korea ■ Made of Rustless Stainless-steel #304

■ Recommended to use with Flexible Coupling for Gentle Stirring & Safety Working

■ The Rod may be Cut to Any Length with a Hacksaw ■ Good Finished : Surface & Stirring Center

(1) 3-bladed Propeller-type, ideal for Universal-use in Middle/High Speed
with Rod $\phi 8\sim 12 \times L500\sim 1000$, Rotor $\phi 50\sim 140$ mm, and Good for Low/Middle Viscosity

* Designed for Efficient Flow : mixed from Top to Bottom of Vessel * Minimum Shearing

SL.StiS721	Stir-Shaft, "S721", #304, Rod- $\phi 8 \times L500$, Rotor- $\phi 50 \times h15$ mm
SL.StiS722	, "S722", - $\phi 8 \times L500$, - $\phi 60 \times h15$ mm
SL.StiS723	, "S723", - $\phi 8 \times L650$, - $\phi 80 \times h20$ mm
SL.StiS724	, "S724", - $\phi 8 \times L650$, - $\phi 100 \times h24$ mm
SL.StiS726	Stir-Shaft, "S726", #304, Rod- $\phi 10 \times L500$, Rotor- $\phi 60 \times h15$ mm
SL.StiS727	, "S727", - $\phi 10 \times L650$, - $\phi 80 \times h20$ mm
SL.StiS728	, "S728", - $\phi 10 \times L800$, - $\phi 100 \times h24$ mm
SL.StiS729	Stir-Shaft, "S729", #304, Rod- $\phi 12 \times L1000$, Rotor- $\phi 140 \times h30$ mm

Ea.	Price, ₩

<Continued On Next Page>

<Continued From...SciLab® Stainless-steel Stirring Shaft >

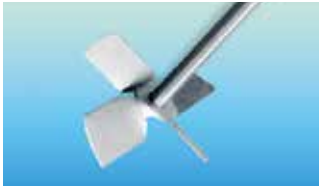

(2) 4-bladed Propeller-type Standard-model

(2) Standard 4-bladed Propeller-type, ideal for Low/Middle Speed & Viscosity
Popular-model, with Rod $\phi 8 \sim 12 \times L500 \sim 1000$, Rotor $\phi 50 \sim 140$ mm, 45° Angled

SL.Sti	Stir-Shaft, "S731", #304, Rod- $\phi 8 \times L500$, Rotor- $\phi 50 \times h20$ mm	Ea.	Price, ₩
SL.StiS732	, "S732", $-\phi 8 \times L500$, $-\phi 70 \times h25$ mm		
SL.StiS733	, "S733", $-\phi 8 \times L650$, $-\phi 90 \times h35$ mm		
SL.StiS734	, "S734", $-\phi 8 \times L650$, $-\phi 110 \times h35$ mm		
SL.StiS736	Stir-Shaft, "S736", #304, Rod- $\phi 10 \times L650$, Rotor- $\phi 90 \times h35$ mm		
SL.StiS737	, "S737", $-\phi 10 \times L800$, $-\phi 110 \times h40$ mm		
SL.StiS738	, "S738", $-\phi 10 \times L1000$, $-\phi 110 \times h40$ mm		
SL.StiS739	Stir-Shaft, "S739", #304, Rod- $\phi 12 \times L1000$, Rotor- $\phi 140 \times h40$ mm		



(3) 4-bladed Dissolver Diamond-type

(3) 4-bladed Dissolver Diamond-type, Good for Particle Reduction in Middle/High Speed
with Rod $\phi 8$ & $10 \times L500 \sim 650$, Rotor $\phi 70 \sim 110$ mm, and Good for Low/Middle Viscosity

SL.Sti	Stir-Shaft, "S741", #304, Rod- $\phi 8 \times L500$, Rotor- $\phi 70 \times h20$ mm	Ea.	Price, ₩
SL.StiS742	, "S742", $-\phi 8 \times L500$, $-\phi 90 \times h25$ mm		
SL.StiS743	, "S743", $-\phi 8 \times L650$, $-\phi 110 \times h25$ mm		
SL.StiS744	Stir-Shaft, "S744", #304, Rod- $\phi 10 \times L650$, Rotor- $\phi 110 \times h25$ mm		

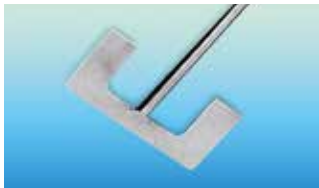

(4) Heavy-duty Anchor-type

(4) Heavy-duty Anchor-type, ideal for Middle/High Viscosity, Rod $\phi 8 \sim 12$ mm
Good for Low/Middle Speed, Rotor $\phi 70 \sim 180$ mm

SL.Sti	Stir-Shaft, "S751", #304, Rod- $\phi 8 \times L500$, Rotor- $\phi 70 \times h14$ mm	Ea.	Price, ₩
SL.StiS752	, "S752", $-\phi 8 \times L650$, $-\phi 90 \times h16$ mm		
SL.StiS753	Stir-Shaft, "S753", #304, Rod- $\phi 10 \times L650$, Rotor- $\phi 90 \times h16$ mm		
SL.StiS754	, "S754", $-\phi 10 \times L800$, $-\phi 140 \times h25$ mm		
SL.StiS755	, "S755", $-\phi 10 \times L1000$, $-\phi 160 \times h30$ mm		
SL.StiS757	Stir-Shaft, "S757", #304, Rod- $\phi 12 \times L1000$, Rotor- $\phi 180 \times h30$ mm		



(5) Heavy-duty Helical Ribbon-type

(5) Heavy-duty Helical Ribbon-type, ideal for Middle/High Viscosity and Lab~Industry
with Rod $\phi 8 \sim 12$ mm, L500~1000, Rotor $\phi 60 \sim 190$ mm, Good for Reaction-system

- * Patented Helical Ribbon High Efficient Mixing Performance * Generates Axial Flow.
- * Designed for Middle / High Viscosity. High Flow Rate and Efficient Mixing.
- * For Homogeneous Mixing and Medium is Conveyed from the Bottom upwards.

SL.Sti	Stir-Shaft, "S761", #304, Rod- $\phi 8 \times L500$, Rotor- $\phi 60 \times h100$ mm	Ea.	Price, ₩
SL.StiS762	, "S762", $-\phi 8 \times L650$, $-\phi 80 \times h130$ mm		
SL.StiS762.1	Stir-Shaft, "S762.1", #304, Rod- $\phi 10 \times L650$, Rotor- $\phi 100 \times h160$ mm		
SL.StiS763	, "S763", $-\phi 10 \times L650$, $-\phi 115 \times h175$ mm		
SL.StiS764	, "S764", $-\phi 10 \times L800$, $-\phi 125 \times h190$ mm		
SL.StiS765	, "S765", $-\phi 10 \times L1000$, $-\phi 160 \times h240$ mm		
SL.StiS766	Stir-Shaft, "S766", #304, Rod- $\phi 12 \times L1100$, Rotor- $\phi 190 \times h290$ mm		

PTFE Stirring Shaft, with Stainless-steel Insert, for Lab & Industrial Overhead Stirrers, Rod $\phi 8$ & $10 \times L300 \sim 650$ mm **NEW**
With Centrifugal & Square-type, High Temperature Resistant and Corrosion-Proof, $-200^{\circ}\text{C} + 260^{\circ}\text{C}$, Normal-grade, PTFE 교반봉/임펠러

- Supplied by SciLab Korea
- Recommended to Use with a Flexible Coupling for Gentle Stirring & Safety Working
- The PTFE Rod with Stainless-steel Insert : ① OD $\phi 8$ mm with $\phi 6$ mm Steel Insert-" $\phi 8/6$ "
② OD $\phi 10$ mm with $\phi 8$ mm Steel Insert-" $\phi 10/8$ "
- Ideal for PURE-Working / Chemically Inert / Non-Contaminating / Thermally Stable
- Exposed Top Rod 4~5cm (Stainless-steel Core) : For Strong Clamping in the Stir-Chuck or Flexible Coupling. ⇒

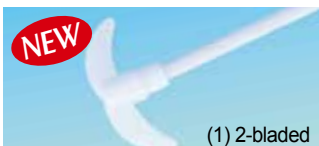
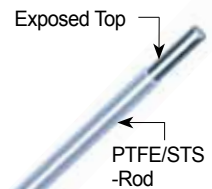

(1) 2-bladed

(1) 2-bladed Centrifugal-type

SL.Sti	PTFE Stirring Rod, $\phi 8/6 \times L300$ mm , Swing rotor- $\phi 63$ mm \times h24mm	Ea.	Price, ₩
SL.StiS4092	, $\phi 8/6 \times L400$ mm , $-\phi 80$ mm \times h25mm		
SL.StiS4093	, $\phi 8/6 \times L500$ mm , $-\phi 100$ mm \times h30mm		
SL.StiS4094	, $\phi 8/6 \times L600$ mm , $-\phi 110$ mm \times h34mm		
SL.StiS4095	, $\phi 10/8 \times L650$ mm, $-\phi 110$ mm \times h34mm		

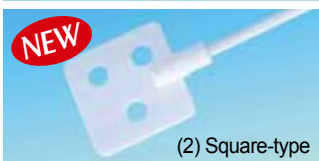

(2) Square-type

(2) Square-type, with $\phi 12$ mm Three Holes

SL.Sti	PTFE Stirring Rod, $\phi 10/8 \times L350$ mm, Rotor 70×70 mm \times t4mm, $3 \times \phi 12$ mm Hole	Ea.	Price, ₩
SL.StiS4099	, $\phi 10/8 \times L450$ mm, Rotor 70×70 mm \times t4mm, $3 \times \phi 12$ mm Hole		

Articles	Cat. No	Description
----------	---------	-------------

SciLab® Hi-grade PTFE Stirring Shaft, with Stainless-steel Insert, for Overhead Stirrers, Rod $\phi 8\sim 14 \times L500\sim 1100\text{mm}$
 Ideal for PURE Working & Universal-use of Wide-range Speed & Viscosity, Chemically Inert, $-200^{\circ}\text{C} + 280^{\circ}\text{C}$ -stable, PTFE 교반봉/임펠러

■ Made in Korea ■ Recommended to Use with a Flexible Coupling for Gentle Stirring & Safety Working.

■ The PTFE Rod with Stainless-steel Insert :

- ① OD $\phi 8\text{mm}$ with $\phi 6\text{mm}$ Steel Insert-“ $\phi 8/6$ ”,
- ② OD $\phi 10\text{mm}$ with $\phi 8\text{mm}$ Steel Insert-“ $\phi 10/8$ ”,
- ③ OD $\phi 12\text{mm}$ with $\phi 10\text{mm}$ Steel Insert-“ $\phi 12/10$ ”, and
- ④ OD $\phi 14\text{mm}$ with $\phi 12\text{mm}$ Steel Insert-“ $\phi 14/12$ ”.

■ Rod may be Cut to Any Length with a Hacksaw.

■ Ideal for PURE-Working / Chemically Inert / Non-Contaminating / Thermally Stable, $-200^{\circ}\text{C} + 280^{\circ}\text{C}$ -stable.

■ Exposed Top Rod 4~5cm (Stainless-steel Core) : For Strong Clamping in the Stir-Chuck or Flexible Coupling. ⇒

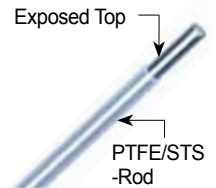

(1) 2-bladed Centrifugal-type
 Good for Narrow-Neck
 <ex> $\text{F}24/-$ & $34/-$ Joint neck

(1) 2-bladed Centrifugal-type, ideal for $\text{F}24/-$ & $\text{F}34/-$ Joints(Narrow) Necks & Low Viscosity
 with Rod $\phi 8$ & $10 \times L500\sim 650$, Rotor $\phi 50\sim 100$ mm, and Good for Middle/High Speed

SL.StiS403	Stir-Shaft, PTFE, Rod- $\phi 8/6 \times L500$	Swingrotor- $\phi 50 \times h14$ mm	fit to $\text{F}24/-$ joints
SL.StiS404	- $\phi 8/6 \times L500$	- $\phi 70 \times h17$ mm	fit to $\text{F}24/-$ joints
SL.StiS405	- $\phi 8/6 \times L650$	- $\phi 100 \times h24$ mm	fit to $\text{F}34/-$ joints
SL.StiS406	Stir-Shaft, PTFE, Rod- $\phi 10/8 \times L650$	Swingrotor- $\phi 100 \times h24$ mm	fit to $\text{F}34/-$ joints

Ea. Price, ₩



(2) Standard 4-bladed Propeller-type

(2) Standard 4-bladed Propeller-type, ideal for Low/Middle Speed and High Viscosity
 Good for Reactors, with Rod $\phi 8\sim 14 \times L500\sim 1100$ and Rotor $\phi 50\sim 140$ mm, 45° Angled

* Standard Stirring Shafts. * Designed for Efficient Mixing : from Top to Bottom of Vessel

SL.StiS410	Stir-Shaft, PTFE, Rod- $\phi 8/6 \times L500$	Rotor- $\phi 50 \times h20\text{mm}$
SL.StiS411	- $\phi 8/6 \times L500$	- $\phi 70 \times h25\text{mm}$
SL.StiS412	- $\phi 8/6 \times L650$	- $\phi 70 \times h25\text{mm}$
SL.StiS413	Stir-Shaft, PTFE, Rod- $\phi 10/8 \times L650$	Rotor- $\phi 90 \times h35\text{mm}$, Good for 5~10Lit Vessels
SL.StiS414	- $\phi 10/8 \times L800$	- $\phi 90 \times h35\text{mm}$, Good for 10~20Lit Vessels
SL.StiS415	- $\phi 10/8 \times L1000$	- $\phi 90 \times h35\text{mm}$, Good for 20~50Lit Vessels
SL.StiS416.1	Stir-Shaft, PTFE, Rod- $\phi 12/10 \times L800$	Rotor- $\phi 110 \times h40\text{mm}$, Good for 10~20Lit Vessels
SL.StiS416.2	- $\phi 12/10 \times L1000$	- $\phi 110 \times h40\text{mm}$, Good for 30~50Lit Vessels
SL.StiS416.3	- $\phi 12/10 \times L1000$	- $\phi 140 \times h40\text{mm}$, Good for 30~80Lit Vessels
SL.StiS417	Stir-Shaft, PTFE, Rod- $\phi 14/12 \times L1100$	Exchangeable Rotor- $\phi 140 \times h40\text{mm}$, Good for 50~100Lit Reactors

Ea. Price, ₩



(3) with 2-Rotors, Propeller-type

(3) with 2-Exchangeable Rotors of 4-bladed Propeller-type, for 20~100Lit Reaction Vessels
 Ideal for High Viscosity/ Large Volume Stirring, with Rod $\phi 12$ & $14 \times L 800\sim 1100$ mm

* Translucent PFA Shaft with Stainless-steel Insert, Totally Chemical Inert

SL.StiS416.4	Stir-Shaft, PTFE, for 20~30Lit, Rod- $\phi 12/10 \times L800$	2-Rotors of (1) Exchangeable 1st Rotor $\phi 110 \times h40$ and (2) Bottom Rotor $\phi 110 \times h40\text{mm}$
SL.StiS418	Stir-Shaft, PTFE, for 30~80Lit, Rod- $\phi 12/10 \times L1000$	2-Rotors of (1) Exchangeable 1st Rotor $\phi 110 \times h40$ and (2) Bottom Rotor $\phi 140 \times h40\text{mm}$
SL.StiS419	Stir-Shaft, PTFE, for 50~100Lit, Rod- $\phi 14/12 \times L1100$	2-Rotors of (1) Exchangeable 1st Rotor $\phi 140 \times h40$ and (2) Bottom Rotor $\phi 140 \times h40\text{mm}$

Ea. Price, ₩



(4) Heavy-duty Anchor-type

(4) Heavy-duty Anchor-type, ideal for Middle/High Viscosity, Rod $\phi 8\sim 12\text{mm}$
 Good for Low/Middle Speed, Rotor $\phi 80\sim 140$ mm, [UK.-made]

CW.005.340.82	Shaft, $\phi 8 \times L400\text{mm}$ Rod, $\phi 80\text{mm}$ Anchor
CW.005.350.82	, $\phi 8 \times L500\text{mm}$ Rod, $\phi 80\text{mm}$ Anchor
CW.005.355.2	, $\phi 10 \times L550\text{mm}$ Rod, $\phi 100\text{mm}$ Anchor
CW.005.0365.102	, Ex-type, $\phi 10 \times L650\text{mm}$ Rod, $\phi 140\text{mm}$ Anchor
CW.005.0375.102	, $\phi 10 \times L750\text{mm}$ Rod, $\phi 140\text{mm}$ Anchor
CW.005.0375.122	, $\phi 12 \times L750\text{mm}$ Rod, $\phi 140\text{mm}$ Anchor
CW.005.03100.122	, $\phi 12 \times L1000\text{mm}$ Rod, $\phi 140\text{mm}$ Anchor

Ea. Price, ₩

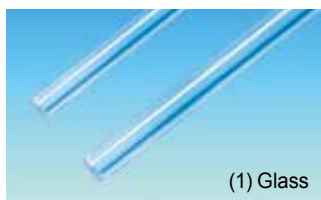

(1) Glass

Glass & PFA (Stainless-steel Insert) PLAIN Shaft, for Exchangeable Rotor
 For Exchangeable Rotor, [Korean-made], 글라스 및 스텐심 PFA봉

(1) DURAN® Glass Shaft, Round Ends, Boro-glass 3.3, $\phi 8$ & 10 , $L400\sim 650\text{mm}$

* Good for Eco-Pure Work

SL.StiS206	Glass Shaft, $\phi 8 \times L400\text{mm}$	Ea. Price, ₩	SL.StiS208	Glass Shaft, $\phi 10 \times L450\text{mm}$
SL.StiS207	, $\phi 8 \times L500\text{mm}$		SL.StiS209	, $\phi 10 \times L550\text{mm}$
			SL.StiS210	, $\phi 10 \times L650\text{mm}$

Ea. Price, ₩

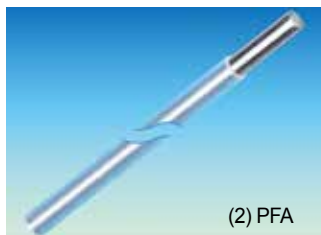

(2) PFA

(2) PFA with Stainless-steel Insert Shaft, $\phi 8\sim 14 \times L500\sim 1100\text{mm}$

* The Rod may be Cut to Any Length with a Hacksaw

* Translucent PFA, Totally Chemical Inert, $-200^{\circ}\text{C} + 260^{\circ}\text{C}$

SL.StiS451	Shaft, PFA, $\phi 8/6 \times L500\text{mm}$	Ea. Price, ₩	SL.StiS455	Shaft, PFA, $\phi 10/8 \times L800\text{mm}$
SL.StiS452	, $\phi 8/6 \times L650\text{mm}$		SL.StiS456	, $\phi 12/10 \times L800\text{mm}$
SL.StiS453	, $\phi 8/6 \times L800\text{mm}$		SL.StiS457	, $\phi 12/10 \times L1000\text{mm}$
SL.StiS454	, $\phi 10/8 \times L650\text{mm}$		SL.StiS458	, $\phi 14/12 \times L1100\text{mm}$

Ea. Price, ₩



(1) Glass-shaft



(2) PTFE-shaft

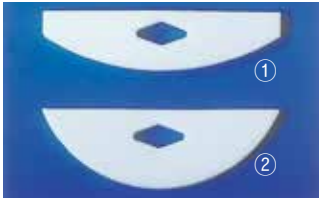

(3) PTFE Blade, with $\phi 6.5$ Connect-hole

GLASS and PTFE/Steel Cored Shaft and PTFE Blade, Exchangeable
Ideal for $\text{ㄱ}24/-$ & $\text{ㄱ}34/-$ Joint (Narrow) Necks, 교체형 글라스 & PTFE 교반봉과 임펠러

* Glass Shafts : DURAN Borosilicate Glass 3.3 Rod $\phi 8$ & 10mm : Made in Korea
 * PTFE Encapsulated Stainless-steel Shafts $\phi 8$ & 12mm, -200°C $+280^{\circ}\text{C}$ Stable : Made in U.K.

(1) GLASS-Shaft, $\phi 8/10$, L400~600mm

SL.StiS260 Glass-Shaft, $\phi 8$, L400mm
 SL.StiS261 , L500mm
 SL.StiS262 , L600mm

Ea. Price, ₩

SL.StiS265 Glass-Shaft, $\phi 10$, L400mm
 SL.StiS266 , L500mm
 SL.StiS267 , L600mm

Ea. Price, ₩

(2) Cowie® PTFE/Steel Cored Shaft, $\phi 8$ & 12mm, L400~750mm, without Blade

* The Rod may by Cut to Any Length with a Hacksaw

CW.005.540.81 Shaft, PTFE, $\phi 8 \times$ L400mm
 CW.005.550.81 , $\phi 8 \times$ L500mm
 CW.005.555.1 , $\phi 10 \times$ L550mm

Ea. Price, ₩

CW.005.565.1 Shaft, PTFE, $\phi 10 \times$ L650mm
 CW.005.0575.101 , $\phi 10 \times$ L750mm
 CW.005.0575.121 , $\phi 12 \times$ L750mm

Ea. Price, ₩

(3) Cowie® PTFE Stir-Blade, Thick-3.2mm, Ideal for $\text{ㄱ}24/-$ & $\text{ㄱ}34/-$ Joint Necks

① with Square End, Fit to $\text{ㄱ}24/-$ Joints

CW.002.052.1 Blade, Squ. $52 \times$ h14mm
 CW.002.076.1 , $76 \times$ h19mm
 CW.002.090.1 , $90 \times$ h28mm

Ea. Price, ₩

② with Plain End, Fit to $\text{ㄱ}34/-$ Joints

CW.002.1065.1 Blade, Pla. $65 \times$ h25mm
 CW.002.1075.1 , $75 \times$ h25mm
 CW.002.1105.1 , $105 \times$ h25mm
 CW.002.1125.1 , $125 \times$ h25mm
 CW.002.1150.1 , $150 \times$ h25mm

Ea. Price, ₩

All PTFE Adjustable / Exchangeable Rotor, Screw Propeller- & Turbine-type
For Shaft $\phi 8 \sim 16$ mm, PTFE 교체형/조절식 교반 임펠러

■ The Exchangeable Rotors fit to $\phi 8 \sim 16$ mm Rods and Lock in place with Screw Nut

(1) SciLab® Exchangeable "Screw Propeller" Rotor, 45° Angled 4 Blade

* Made in Korea

SL.StiS461 Rotor, PTFE, for Shaft- $\phi 8$, Rotor- $\phi 50 \times$ h20mm
 SL.StiS462 , $\phi 70 \times$ h25mm
 SL.StiS463 , for Shaft- $\phi 10$, Rotor- $\phi 70 \times$ h25mm
 SL.StiS464 , $\phi 90 \times$ h35mm
 SL.StiS465 , for Shaft- $\phi 12$, Rotor- $\phi 110 \times$ h40mm
 SL.StiS466 , for Shaft- $\phi 14$, Rotor- $\phi 140 \times$ h40mm

Ea. Price, ₩



(1) "Screw Propeller" only $\phi 50 \sim \phi 140$ mm



(2) "Turbine" Rotor Only $\phi 50 \sim \phi 150$ mm

(2) Cowie® Exchangeable "Turbine" Rotor only, $\phi 50 \sim 150$ mm

* Made in UK.

CW.005.90850 Rotor, PTFE, for Shaft- $\phi 8$ mm, Rotor- $\phi 50$ mm
 CW.005.90875 , $\phi 75$ mm
 CW.005.91075 , for Shaft- $\phi 10$ mm, Rotor- $\phi 75$ mm
 CW.005.910100 , $\phi 100$ mm
 CW.005.912100 , for Shaft- $\phi 12$ mm, Rotor- $\phi 100$ mm
 CW.005.916150 , for Shaft- $\phi 16$ mm, Rotor- $\phi 150$ mm

Ea. Price, ₩

Kartell® PP & PVC Plastic Stirring Shaft, PP-Blade, PVC-Rod with Steel Core, Rod $\phi 8 \times$ L350mm
Good for Acid & Chemicals resistance, PP & PVC 플라스틱 교반봉/임펠러

■ Supplied by Kartell® in Italy
 ■ Ideal for Acids, Chemicals and Anti-corrosion
 ■ Material : PP-Blade, PVC-Rod with Steel Core : $\phi 8 \times$ L350 mm



(1) (2) (3) (4)

KA.428 (1) Stirring Paddle, with 2 fixed blade (w39 \times h15 mm), Rod $\phi 8 \times$ L350mm
 KA.430 (2) , "U" shaped blade (w65 \times h78 mm), Rod $\phi 8 \times$ L350mm
 KA.431 (3) , with 2 flexible paddle (Swing w57 mm), Rod $\phi 8 \times$ L350mm
 KA.432 (4) , with 2 flexible paddle (Swing w98 mm), Rod $\phi 8 \times$ L350mm

Ea. Price, ₩

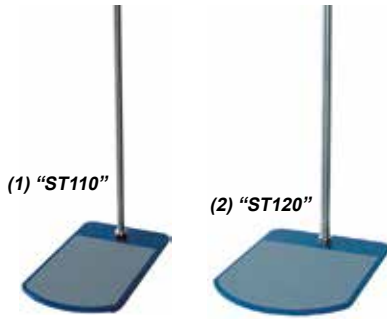

DAIHAN® Premium Plate Stand, High Quality
With Stainless-steel Rod ϕ 16/23mm

- Made in Korea ■ High-Quality Plate-type Stand with Support Rod
- Wide and Thick Steel Plate for Safety Mechanism ■ Silicon Rubber Pad adhered
- with 1.5P Screwed Support Rod made of Stainless-steel specially designed

DH.WOS501510	(1) "ST110" Standard Steel Plate Stand, Powder Coated, with Base Plate/Silicone Pad, for Stirrer and Homogenizer, Base Plate w20×35cm "RD 511" 1.5P Screw Rod, ϕ 16×h800 mm	Ea.	Price, ₩
DH.WOS501515	(2) "ST120" Wide Steel Plate Stand, Powder Coated, with Base Plate/Silicone Pad, for Stirrer and Homogenizer, Base Plate w30×40 cm "RD 522" 1.5P Screw Rod, ϕ 23×h1000 mm	Ea.	Price, ₩

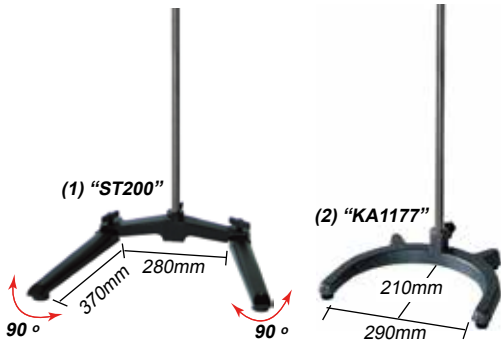

DAIHAN® Heavy Duty Safety Stand, High Safety
With Stainless-steel Rod ϕ 23mm

- Made in Korea ■ Never Fall Down by Safety Mechanism.
- High-Safety H-U-type Stand with Stainless-steel Support Rod
- Adjustable Foot Distance (ST200)

(1) Adjustable Foot Distance Deluxe Safety Stand		Ea.	Price, ₩
DH.WOS501520	Deluxe Safety Stand, "ST200", H-type Base w39~75cm adjust, Rod ϕ 23×h1200mm		
(2) U-type Safety Stand		Ea.	Price, ₩
DH.WOS1177	Safety Stand, "KA1177", U-type Base w34/29×27/21cm, Rod ϕ 23×h800mm		



SciLab® Universal Jumbo Clamp Holder, Cast Aluminium, Grip Capa. ϕ 25mm
Ideal for Overhead Stirrer, Safety/Strong Grip Power, **만능점보홀더**

- Made in Korea * Cast-Aluminium * Ideal for Overhead Stirrers, Homogenizers, etc.

SL.Cla8011	Clamp Holder, "CL200", Cast Aluminum, Grip Capa. ϕ 25mm, L135mm	Ea.	Price, ₩
------------	--	-----	----------

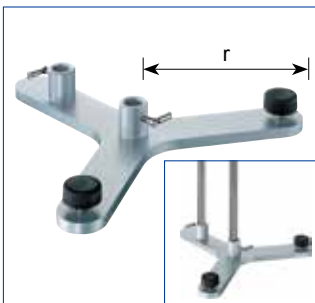

Steel Retort Base Duo Stand, for 2× Plain Rods of up to ϕ 16mm, without Rod
With Hinged Set Screw M6, Nonskid Feet equipped, 2× Level Screw Nut, and Base Thick-8mm

- Made in Germany * Can Fix Rods up to 2ea (Below ϕ 16mm)

Retort Stand Base only		Ea.	Price, ₩
US.2040	Stand Base only, "US2040", r =150 mm		
US.2041	"US2041", r =185mm		
Optional Stainless-steel Rod of ϕ 16mm, without Screw		Ea.	Price, ₩
DH.WOS502001	Stainless-steel Rod, "RD501", ϕ 16×h800mm , non-screw		
DH.WOS502002	"RD502", ϕ 16×h1000mm, non-screw		
DH.WOS502003	"RD503", ϕ 16×h1200mm, non-screw		

DAIHAN® ϕ 16 & 23mm High-Quality Stainless-steel (#304) Rod, for Stand Bases

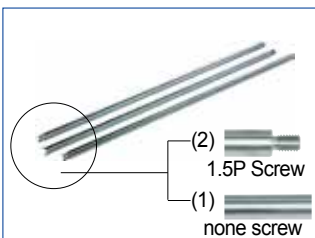

Stainless-steel Rod
With or Without 1.5P Screw

(1) Plain-type ϕ 16mm Rod, without Screw		Ea.	Price, ₩
DH.WOS502001	Stainless-steel Rod, "RD501", ϕ 16×h800mm , non-screw		
DH.WOS502002	"RD502", ϕ 16×h1000mm, non-screw		
DH.WOS502003	"RD503", ϕ 16×h1200mm, non-screw		
DH.WOS502031	"RD531", ϕ 23×h800mm , non-screw		
DH.WOS502033	"RD533", ϕ 23×h1200mm, non-screw		
(2) 1.5P Screw-type ϕ 16 & 23mm Rod		Ea.	Price, ₩
DH.WOS502011	Stainless-steel Rod, "RD511", ϕ 16×h800mm , 1.5P Screw		
DH.WOS502012	"RD512", ϕ 16×h1000mm, 1.5P Screw		
DH.WOS502013	"RD513", ϕ 16×h1200mm, 1.5P Screw		
DH.WOS502021	"RD521", ϕ 23×h800mm , 1.5P Screw		
DH.WOS502022	"RD522", ϕ 23×h1000mm, 1.5P Screw		
DH.WOS502023	"RD523", ϕ 23×h1200mm, 1.5P Screw		

Ultrasonic Cleaner

Ultrasonic Cleaner - Analog P. 245
- **Digital** P. 246
- **Remote Control, Large Capacity** ... P. 247

• **Analog Ultrasonic Cleaner**



“WUC-A”

• **Digital Ultrasonic Cleaner**



“WUC-D”



• **Large Capacity Ultrasonic Cleaner**



“WUC-N”



Wire Basket
(Optional)



Remote
Generator

DAIHAN® Analog Ultrasonic Cleaner “WUC-A”, Timer/Temp. Output Controller, with Certi. & Traceability, 1.2~22 Lit
 With Stainless-steel Flat Lid, Highly Effective Cleaning, up to 85 °C, 0~30min, 40kHz Frequency, without Basket
 초음파 세척기, 온도 및 시간 설정, 고효율, 다용도, 리드 포함



10 Lit Analog Ultrasonic Cleaner with Flat Lid
 “WUC-A10H”



6 Lit Analog Ultrasonic Cleaner with Flat Lid
 “WUC-A06H”

- Made in Korea
- CE Certified
- with Certificate & Traceability : Controlled by Serial Number, Certificate, Delivery-information, and Traceable Data Base System
- Made of Stainless-steel, Finished Surface
- Analog Controller, Timer, Temperature and Output Control
- PL(Product Liability) Insurance

- * Useful for Cleaning to Remove Dirt, Grease, Waxes and Oil from all Lab Instruments by Ultrasonic Frequency
- * Made of Stainless-steel, Finished Surface
- * Analog Controller, Timer, Temperature and Output Control
- * Temperature Range from Ambient to 85°C. (1.2 & 1.8 Lit : 65°C Fixed)
- * Convenient Preset Function : Heating and Timer
- * HF-Frequency : 40kHz
- * Bottom-Mounted Drain (WUC-A10H and WUC-A22H)
- * Maximum 30 minutes of Cleaning Time (Except WUC-A10H)

Specifications & Ordering information

Spec. \ Model	“WUC-A01H” Max. Capa. 1.2 Lit	“WUC-A02H” Max. Capa. 1.8 Lit	“WUC-A03H” Max. Capa. 3.3 Lit	“WUC-A06H” Max. Capa. 6 Lit	“WUC-A10H” Max. Capa. 10 Lit	“WUC-A22H” Max. Capa. 22 Lit	
Capacity	1.2 Lit	1.8 Lit	3.3 Lit	6 Lit	10 Lit	22 Li	
Frequency	40KHz						
HF-Peak Out	72 W	75 W	124 W	168 W	265 W	379 W	
Heating Temp.	65 °C Fixed	65 °C Fixed	ambient to 85 °C	ambient to 85 °C	ambient to 85 °C	ambient to 85 °C	
Heating Power	86 W	86 W	172 W	172 W	258 W	275 W	
Timer	None	0~30 min.	0~30 min.	0~30 min.	0~30 min.	0~30 min.	
Drain-Valve	None	None	None	None	1/2" NPT	1/2" NPT	
Tank Size inner (w×d×h) (mm)	150×135×60	150×135×100	240×140×100	290×150×150	290×240×150	500×300×150	
Weight	1.8 kg	2.5 kg	4 kg	5.3 kg	7 kg	11 kg	
Packing Dimension (w×d×h) (mm)	200×200×190	200×200×240	320×200×290	370×220×350	430×320×360	640×380×370	
Gross Weight	3 kg	4 kg	5 kg	6 kg	7 kg	11 kg	
Power Consumption	158 W	161 W	296 W	340 W	523W	654 W	
Electrical Reqts.	1 Phase, AC 120 V, 60 Hz or AC 230 V, 50 / 60 Hz						
Cat. No.	230V	DH.WUC.A01H	DH.WUC.A02H	DH.WUC.A03H	DH.WUC.A06H	DH.WUC.A10H	DH.WUC.A22H
	120V	DH.WUC.A101H	DH.WUC.A102H	DH.WUC.A103H	DH.WUC.A106H	DH.WUC.A110H	DH.WUC.A122H
Price, Each. ₩							

* Other Specifications are available upon Customer’s Request.

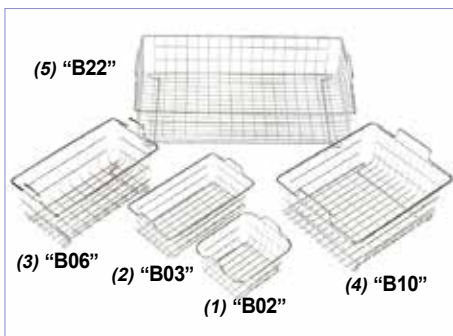

Stainless-steel Wire Basket (Optional)

Optional Stainless-steel Wire Basket

- DH.WUC.B02 (1) Basket, Wire, “B02”, for 1.8 Lit, 144×131×h92mm
- DH.WUC.B03 (2) , “B03”, for 3.3 Lit, 224×128×h83mm
- DH.WUC.B06 (3) , “B06”, for 6 Lit, 267×136×h126mm
- DH.WUC.B10 (4) , “B10”, for 10 Lit, 276×218×h132mm
- DH.WUC.B22 (5) , “B22”, for 22 Lit, 467×275×h131mm

Ea. Price, ₩

DAIHAN® Digital Ultrasonic Cleaner-set “WUC-D”, Microprocessor Control, 3.3~22 Lit
 With Stainless-steel Wire Basket & Flat Lid, Highly Effective Cleaning, up to 80°C, 0~60min, 40kHz Frequency
 디지털 초음파 세척기 세트, 와이어 바스켓 및 리드 포함, 마이크로프로세서 제어



10 Lit Digital Ultrasonic Cleaner Set, “WUC- D10H” with Flat Lid and Wire Basket



3.3 Lit Digital Ultrasonic Cleaner Set , “WUC- D03H” with Flat Lid and Wire Basket

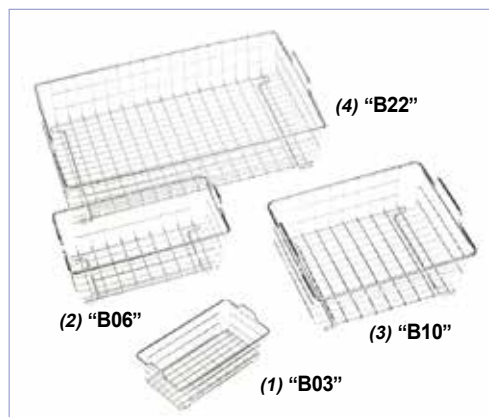

Stainless-steel Wire Basket (included)

- Made in Korea
 - CE Certified
 - with Certificate & Traceability : Controlled by Serial Number, Certificate, Delivery-information, and Traceable Data Base System
 - Useful for Cleaning to Remove Dirt, Grease, Waxes and Oil from all Lab Instruments by Ultrasonic Frequency
 - Microprocessor Control : Timer, Temperature and Output Control
 - PL (Product Liability) Insurance
- * Useful for Cleaning to Remove Dirt, Grease, Waxes and Oil from all Lab instruments by Ultrasonic Frequency
 - * Microprocessor Control : Timer, Temperature and Output Control
 - * Multi-Frequency Sonication Body
 - * HF - Frequency : 40kHz
 - * Temperature Range from Ambient to 80°C
 - * Convenient Preset Function : Heating and Timer
 - * Drain is mounted in the bottom (WUC-D10H, WUC-D22H)
 - * Maximum 60 minutes of Cleaning Time
 - * Very Strong Cleansing Degassing & Sweep Function

Specifications & Ordering information

Spec.	Model	“WUC-D03H”	“WUC-D06H”	“WUC- D10H”	“WUC-D22H”
		Max. Capa. 3.3 Lit	Max. Capa. 6 Lit	Max. Capa. 10 Lit	Max. Capa. 22 Lit
Capacity		3.3 Lit	6 Lit	10 Lit	22 Lit
Frequency		40kHz	40kHz	40kHz	40kHz
HF-peak out		100W	253W	407W	528W
Heat temp.		ambient to 80°C	ambient to 80°C	ambient to 80°C	ambient to 80°C
Heating Power		172W	172W	258W	344W
Timer		0~30 min.	0~60 min.	0~60 min.	0~60 min.
Display		FND			
Drain-valve		None	None	1/2" NPT	1/2" NPT
Tank Size inner (w×d×h) (mm)		240×140×100	290×150×150	290×240×150	500×300×150
Weight net		3.4 kg	5.8 kg	8 kg	12.9 kg
Packing Dimension (w×d×h) (mm)		320×200×290	360×220×350	440×320×360	640×380×370
Gross Weight		3.7 kg	6.3 kg	8.5 kg	13.4 kg
Power Consumption		290W	425W	665W	872W
Electrical Reqts.		1 Phase, AC 120 V, 60 Hz or AC 230 V, 50 / 60 Hz			
Cat. No.	230V	DH.WUC.D03H	DH.WUC.D06H	DH.WUC.D10H	DH.WUC.D22H
	120V	DH.WUC.D103H	DH.WUC.D106H	DH.WUC.D110H	DH.WUC.D122H
Price, Each. ₩					

* Other Specifications are available upon Customer's Request.

Spare Wire Basket, Stainless-steel

- DH.WUC.B03 (1) Basket, Wire, “B03”, for 3.3 Lit, 224×128×h83mm
- DH.WUC.B06 (2) , “B06”, for 6 Lit, 267×136×h126mm
- DH.WUC.B10 (3) , “B10”, for 10 Lit, 276×218×h132mm
- DH.WUC.B22 (4) , “B22”, for 22 Lit, 467×275×h131mm

Ea. Price, ₩

Articles	Cat. No	Description
----------	---------	-------------

DAIHAN® Large Capacity Ultrasonic Cleaner-set “WUC-N”, Remote Control System, 30~74 Lit
 With Digital Remote Generator/Stainless-steel Flat Lid/Drain Valve, Highly Effective Cleaning, without Basket, up to 105 °C, 40kHz
 대용량 초음파 세척기 세트, 리모트 제너레이터 · 리드 · 드레인 밸브 포함



2-Year Warranty

Wire Basket (Optional)
Remote Generator

47 Lit Large Capacity Ultrasonic Cleaner-set Without Basket “WUC-N47H”

- Made in Korea ■ CE Certified
- with Certificate & Traceability : Controlled by Serial Number, Certificate, Delivery-information, and Traceable Data Base System
- Useful for Cleaning to Remove Dirt, Grease, Waxes and Oil from all Lab Instruments by Ultrasonic Frequency
- Remote Generator : Power Control and Timer Function with LCD
- PL (Product Liability) Insurance
- * Useful for Cleaning to Remove Dirt, Grease, Waxes and Oil from all Lab Instruments by Ultrasonic Frequency.
- * Remote Generator : Power Control and Timer Function with LCD
- * BTL Sonicator Installed : Robust and Stable Running
- * Sweep Function can Realize Complete Cleaning by the Dispersion of Ultrasound
- * Auto Optimization of Frequency as various Water Level and Temperature.
- * Foot Switch Control
- * HF-Frequency : 40kHz
- * Temperature Range from Ambient to 105°C
- * Supply Full Set with Lid, Foot Switch and Generator (Basket excluded)
- * Drain is mounted in the bottom
- * Maximum 99minutes of Cleaning Time



Stainless-steel Wire Basket (Optional)

Specifications & Ordering information

Spec.	Model	“WUC-N30H”	“WUC-N47H”	“WUC-N60H”	“WUC-N74H”
		Max. Capa. 30 Lit	Max. Capa. 47 Lit	Max. Capa. 60 Lit	Max. Capa. 74 Lit
Capacity		30 Lit	47 Lit	60 Lit	74 Lit
HF-frequency		40kHz	40kHz	40kHz	40kHz
HF-peak out		704W	990W	1,210W	1,430W
Heat temp.		ambient to 105°C	ambient to 105°C	ambient to 105°C	ambient to 105°C
Heating Power		990W			
Timer (min)		0~99 min.	0~99 min.	0~99 min.	0~99 min.
Tank Size inner (w×d×h) (mm)		400×300×250	450×350×300	500×400×300	550×450×300
Tank Size external (w×d×h) (mm)		480×380×400	530×430×450	530×430×450	580×480×450
Power Consumption		1,694W	1,980W	2,200W	2,420W
Weight net		26kg	31kg	36kg	41kg
Packing Dimension (w×d×h) (mm)		620×520×640	670×570×710	720×620×710	770×670×710
Gross Weight		32 kg	37 kg	42 kg	47 kg
Remote Generator	Display LCD	FND			
	Power	600W	900W	1,200W	1,500W
	Weight	9kg	10kg	10kg	10kg
Cat. No.	230V	DH.WUC.N30H	DH.WUC.N47H	DH.WUC.N60H	DH.WUC.N74H
	120V	DH.WUC.N130H	DH.WUC.N147H	DH.WUC.N160H	DH.WUC.N174H
Price, Each. ₩					

* Other Specifications are available upon Customer’s Request.

Optional Wire Basket, Stainless-steel

- SL.Bas7021 Basket, Wire, “Bas7021”, for 30Lit., 340×240×h150mm
- SL.Bas7022 , “Bas7022”, for 47Lit., 390×290×h200mm
- SL.Bas7023 , “Bas7023”, for 60Lit., 440×340×h200mm
- SL.Bas7024 , “Bas7024”, for 74Lit., 490×390×h200mm

Ea. Price, ₩

ViscoMeter

Multi-speed Rotary Viscometer-full Set	P. 250
Portable Rotary Viscometer-full Set	P. 253
Programmable Rotary Viscometer-full Set	P. 251
Remote Temp. Control Rotary Viscometer-full Set	P. 252
Standard Rotary Viscometer-full Set	P. 249

Standard Rotary Viscometer

“WVS” model



Programmable Rotary Viscometer

“WVP” model



Remote Temp. Control Rotary Viscometer
“WVT” model

DAIHAN® Standard Rotary Viscometer-full Set “WVS-0.1M” & “WVS-2M”, with Calibration Certificate, 1~2,000,000 cP With Standard Spindle-kit(LV1~4), Lifting Stand, Hand Handling Case, 0.3~60rpm, 표준형 디지털 회전 점도계-풀세트



Standard Rotary Viscometer Full Set “WVS”

- Ideal for measuring the Viscosity of Various Liquid such as Grease, Painting, Foodstuff, Dope, Paper making, Cosmetics, Chemical industry, Capsule Stickiness Agent and Medicines.
 - Component of Set : Viscometer Unit “WVS”, Spindle Kit(LV 1~4), Lifting Stand, Hand Handling Case, Calibration Certificate
 - Included ASTM Standard Spindle-kit of 4 Ea. : LV1 : 15~20K, LV2 : 50~100K, LV3 : 200~400K, LV4 : 1K~2M
 - Direct Readout of all Measurement Parameters on an illuminated LCD.
 - The Viscometer is equipped with many Pre-sets speeds : (“WVS-0.1M” : 6- / 12- / 30- / 60- RPM, “WVS-2M” : 0.3- / 0.6- / 1.5- / 3- / 6- / 12- / 30- / 60-RPM)
 - Auto Range Function to determine the Maximum Viscosity with each Spindle / Speed Combination.
 - Safety Protection Against Sudden Rises in the Power Supply.
- * Data on screen :
 • Speed Selected : RPM
 • Viscosity Reading : cP(mPa.s)
 • Sample Temperature : °C
 • Spindle Selected : S.P.
 • Percentage of Full Scale : %
- * Viscosity Reading : Dynamic Viscosity (cP or mPa.s)
 * The Viscometer and the PT100 can be calibrated by the User.
 * Ultra-sensitive Front Keyboard that allows Easy Input of all Parameters.
 * Error Message in the Screen with Sound Alarm when the Viscosity of the Test Material exceeds the Full Scale of the selected Combination(SP / rpm.)
 * Sound Alarm if the Equipment is Working at Under 20% of Selected full Scale
 * Direct reading in cP(mPa.s) without Limits
 * Can be Use with Various Optional Accessories : Ultra-Low Viscosity Adaptor RTD Temp. Probe, Micro Printer

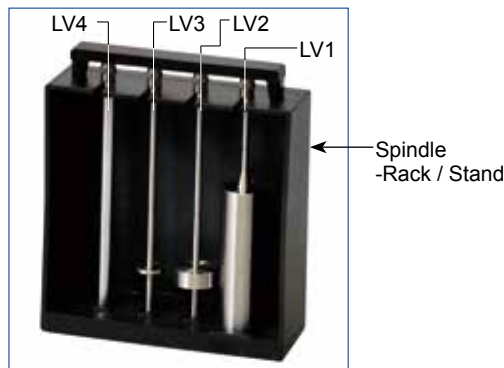

(1) Standard LV Spindle kit, LV1 ~ 4
Included for “WVS-0.1M” & “WVS-2M” Meter



(2) Ultra-Low Viscosity Adaptor



(3) RTD Temp. Probe



(4) Micro Printer, with Cable

Specifications & Ordering information

Spec.	Model	A. “WVS-0.1M” Max. Viscosity. 100,000 cP	B. “WVS-2M” Max. Viscosity. 2,000,000 cP
Viscosity Range, cP(mPa.s)		1 ~ 100,000 cP	1 ~ 2,000,000 cP
Speed Range (RPM)		6, 12, 30, 60	0.3, 0.6, 1.5, 3, 6, 12, 30, 60
Certificate		with Individual Calibration Certificate	
ASTM Standard Spindle-kit & Measure Viscosity Range : cP		Included Standard Spindle-kit(LV1~LV4), Stainless-steel ① LV1 : 15 ~ 20,000cP ② LV2 : 50 ~ 100,000cP ③ LV3 : 200 ~ 400,000 cP ④ LV4 : 1,000 ~ 2,000,000cP ※ LV0 Spindle for 1~20cP(Optional)	
Measurement Error		±5% (Newton Liquid)	
Accuracy		±1.0% of range	
Repeatability		±0.5%	
Ambient Temperature		5°C ~ 35°C Relative Humidity : ≤80%	
Weight		4 kg	
Electrical Reqts.		AC 230V, 50/60Hz	
Cat. No.	230V	DH.WV1011	DH.WV1012
Price, Each. ₩			

* K=1,000 cP(mPa.s), M =1,000,000 cP(mPa.s)

Spare Spindle-kit

	Ea. Price, ₩
DH.WV2011 (1) Standard LV Spindle kit, LV1 ~ 4, LV1 : 15~20K, LV2 : 50~100K, LV3 : 200~400K, LV4 : 1K~2M	

Optional Temp. Probe/Printer/Spindle

	Ea. Price, ₩
DH.WV2011.2 (2) Ultra-Low Viscosity Adaptor for 1~20cP (LV0 Spindle) * Please order with the product!, Calibration is required because there is no Software and Data of LV0 in the Viscometer	
DH.WV2041 (3) RTD Temp. Probe, 0.0~100.0°C, Accu. ±0.1, Resolution 0.1°C	
DH.WV2043 (4) Micro Printer, with RS-232, USB 1.5m Cable (Print Information : Temp., RPM, Spindle, Torque, Viscosity)	

DAIHAN® Multi-speed Rotary Viscometer-full Set “WVM-0.6M” & “WVM-6M”, 1~6,000,000 cP

With Cal. Certi. & Standard Spindle kit(LV1~4), Lifting Stand, Hand Handling Case, 0.1~60-/100-rpm, 멀티 스피드 디지털 회전 점도계



Multi-speed Rotary Viscometer Full Set “WVM”

- Ideal for measuring the Viscosity of Various Liquid such as Grease, Painting, Foodstuff, Dope, Paper making, Cosmetics, Chemical industry, Capsule Stickiness Agent and Medicines.
- Component of Set : Viscometer Unit “WVM”, Spindle Kit(LV 1~4), Lifting Stand, Hand Handling Case, Calibration Certificate
- Included ASTM Standard Spindle-kit of 4 Ea. : LV1 : 15~20K, LV2 : 50~100K, LV3 : 200~400K, LV4 : 1K~2M
- Direct Readout of all Measurement Parameters on an illuminated LCD.
- Available Pre-sets speeds, 0.1~100 rpm
- Auto Range Function to determine the Maximum Viscosity with each Spindle / Speed Combination.
- Safety Protection Against Sudden Rises in the Power Supply.

- * Data on screen :
 - Speed Selected : RPM
 - Spindle Selected : S.P.
 - Viscosity Reading : cP(mPa.s)
 - Percentage of Full Scale : %
 - Sample Temperature : °C
- * Viscosity Reading : Dynamic Viscosity (cP or mPa.s)
- * The Viscometer and the PT100 can be calibrated by the User.
- * Ultra-sensitive Front Keyboard that allows Easy Input of all Parameters.
- * Error Message in the Screen with Sound Alarm when the Viscosity of the Test Material exceeds the Full Scale of the selected Combination(SP / rpm.)
- * Sound Alarm if the Equipment is Working at Under 20% of Selected full Scale
- * Direct reading in cP(mPa.s) * without Limits
- * Can be Use with Various Optional Accessories : Ultra-Low Viscosity Adaptor RTD Temp. Probe, Micro Printer, Small Sample Adapter

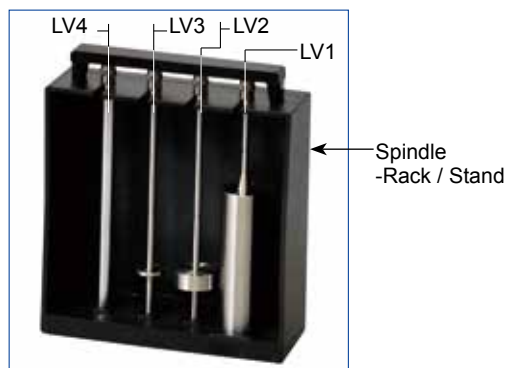

(1) Standard LV Spindle kit, LV1~4
Included for “WVM-0.6M” & “WVM-6M” Meter

Specifications & Ordering information

Spec.	Model	A. “WVM-0.6M” Max. Viscosity. 600,000cP	B. “WVM-6M” Max. Viscosity. 6,000,000cP
Viscosity Range cP(mPa.s)		1 ~ 600,000cP	1 ~ 6,000,000cP
Speed Range (RPM)		1 ~ 60	0.1 ~ 100
Certificate		with Individual Calibration Certificate	
Certificate		Included Standard Spindle-kit(LV1~LV4), Stainless-steel ① LV1 : 15 ~ 20,000cP ② LV2 : 50 ~ 100,000cP ③ LV3 : 200 ~ 400,000 cP ④ LV4 : 1,000 ~ 2,000,000cP ※ LV0 Spindle for 1~20cP(Optional)	
Measurement Error		± 5% (Newton Liquid)	
Accuracy		± 1.0% of range	
Repeatability		± 0.5%	
Ambient Temperature		5°C ~ 35°C Relative Humidity : ≤ 80%	
Weight		4 kg	
Electrical Reqts.		AC 230V, 50/60Hz	
Cat. No.		DH.WV1021	DH.WV1022
Price, Each. ₩			

* K=1,000 cP(mPa.s), M =1,000,000 cP(mPa.s)



(2) Ultra-Low Viscosity Adaptor



(3) RTD Temp. Probe



(4) Small Sample Adapter



(5) Micro Printer, with Cable

Spare Spindle-kit

DH.WV2011 (1) Standard LV Spindle kit, LV1~4,
LV1 : 15~20K, LV2 : 50~100K, LV3 : 200~400K, LV4 : 1K~2M Ea. Price, ₩

Optional Temp. Probe/Sample Adapter/Printer/Spindle

DH.WV2011.2 (2) Ultra-Low Viscosity Adaptor for 1~20cP (LV0 Spindle) Ea. Price, ₩

* Please order with the product!
because there is no Software and Data of LV0 in the Viscometer

DH.WV2041 (3) RTD Temp. Probe, 0.0~100.0°C, Accu. ± 0.1, Resolution 0.1 °C Ea. Price, ₩

DH.WV2042 (4) Small Sample Adapter, Stainless-steel, 2~16ml

DH.WV2043 (5) Micro Printer, with RS-232, USB 1.5m Cable
(Print Information : Temp., RPM, Spindle, Torque, Viscosity)

DAIHAN® Programmable Rotary Viscometer-full Set “WVP-6M” & “WVP-40M”, 1~40,000,000cP
 With Calibration Certificate & Standard Spindle-kit(LV1~4) & (RV2~7), Lifting Stand, 0.1~200rpm, 프로그램식 디지털 회전 점도계



Programmable Rotary Viscometer Full Set “WVP”

- Ideal for measuring the Viscosity of Various Liquid : Grease, Painting, Foodstuff, Dope, Paper making, Cosmetics, Chemical industry, Capsule Stickiness Agent, Medicines.
- Component of Set : Viscometer Unit “WVP”, Spindle Kit, Lifting Stand, Hand Handling Case, Calibration Certificate
- Included ASTM Standard Spindle-kit of 4 or 6 Ea. : “WVP-6M” model - LV1, LV2, LV3, LV4 / “WVP-40M” model - RV2, RV3, RV4, RV5, RV6, RV7
- Available Pre-sets speeds, 0.1~200 rpm
- Auto Test of the Equipment by scanning at Different Speeds, with Audible and Visual warning if it is not Operating Properly.
- Datalogger Function of the obtained results when an Experiment is performed
- Safety Protection Against Sudden Rises in the Power Supply.
- Auto Range Function to determine the Maximum Viscosity with each Spindle / Speed Combination.

- * Data on screen :
 - Speed Selected : RPM
 - Viscosity Reading : cP (mPa.s)
 - Sample Temperature : °C
 - Spindle Selected : S.P.
 - Percentage of Full Scale : %
- * Shear Rate (with special spindles) : SR
- * Shear Stress (with special spindles) : SS
- * Determination of Relative Viscosity and Absolute Viscosity
- * Viscosity Reading : Dynamic Viscosity (cP or mPa.s)
- * Determination of Shear Rate and Shear Stress with Coaxial Spindles.
- * The Viscometer and the PT100 can be calibrated by the User.
- * Ultra-sensitive front Keyboard that allows Easy Input of all Parameters.
- * Error Message in the Screen with Sound Alarm when the Viscosity of the Test Material exceeds the Full Scale of the selected Combination(SP/rpm.)
- * Sound Alarm if the Equipment is working at under 10% of selected Full Scale.
- * Can be Use with Various Optional Accessories : Ultra-Low Viscosity Adaptor RTD Temp. Probe, Micro Printer, Small Sample Adapter



(1) LV1 ~ 4 Spindle kit : Included for A. “WVP-6M”



(2) Ultra-Low Viscosity Adaptor

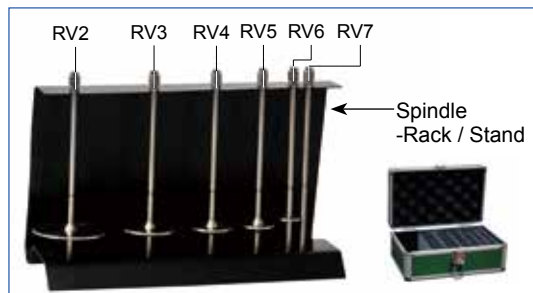

(3) RV2~7 Spindle kit : Included for B. “WVP-40M”



(4) RTD Temp. Probe



(5) Small Sample Adapter



(6) Micro Printer, with Cable

Specifications & Ordering information

Spec.	Model	A. “WVP-6M”	B. “WVP-40M”
		Max. Viscosity. 6,000,000cP	Max. Viscosity. 40,000,000cP
Viscosity Range cP(mPa.s)		1 ~ 6,000,000cP	100 ~ 40,000,000cP
Speed Range (RPM)		0.1 ~ 200	
Certificate		with Individual Calibration Certificate	
Included Spindle Kit		(1) LV1 ~ 4	(3) RV2 ~ 7
ASTM Standard Spindle-set (Stainless-steel) & Measure Viscosity Range : cP		① LV1 : 15 ~ 20,000cP ② LV2 : 50 ~ 100,000cP ③ LV3 : 200 ~ 400,000cP ④ LV4 : 1,000 ~ 2,000,000cP ※ LV0 Spindle for 1~20cP(Optional)	① RV2 : 100 ~ 80,000cP ② RV3 : 100 ~ 200,000cP ③ RV4 : 200 ~ 400,000cP ④ RV5 : 400 ~ 800,000cP ⑤ RV6 : 1,000 ~ 2,000,000cP ⑥ RV7 : 4,000 ~ 8,000,000cP
Measurement Error		± 5% (Newton Liquid)	
Accuracy / Repeatability		± 1.0% of range / ± 0.5%	
Ambient Temperature		5°C ~ 35°C Relative Humidity : ≤ 80%	
Weight		4 kg	
Electrical Reqts.		AC 230V, 50/60Hz	
Cat. No.		DH.WV1031	DH.WV1032
Price, Each. ₩			

* K=1,000 cP(mPa.s), M =1,000,000 cP(mPa.s)

Spare Spindle-kit

- DH.WV2011 (1) Standard LV Spindle kit, LV1~4, LV1 : 15~20K, LV2 : 50~100K, LV3 : 200~400K, LV4 : 1K~2M
- DH.WV2021 (3) Standard RV Spindle kit, RV2~RV7 RV2 : 100~80K, RV3 : 100~200K, RV4 : 200~400K, RV5 : 400~800K, RV6 : 1K~2M, RV7 : 4K~8M

Ea. Price, ₩

Optional Temp. Probe/Sample Adapter/Printer /Spindle

- DH.WV2011.2 (2) Ultra-Low Viscosity Adaptor for 1~20cP(LV0 Spindle)
* Please order with the product!
because there is no Software and Data of LV0 in the Viscometer
- DH.WV2041 (4) RTD Temp. Probe, 0.0~100.0°C, Accu. ±0.1, Resolution 0.1°C
- DH.WV2042 (5) Small Sample Adapter, Stainless-steel, 2~16ml
- DH.WV2043 (6) Micro Printer, with RS-232, USB 1.5m Cable
(Print Information : Temp., RPM, Spindle, Torque, Viscosity)

Ea. Price, ₩

Ea. Price, ₩

DAIHAN® Remote Temp. Control Rotary Viscometer-full Set “WVT-0.33M” & “WVT-3.3M”, 5~3,300,000cP
 With Calibration Certificate & Spindle-kit(LV1~4) & (RV2~7), Lifting Stand, 0.1~100rpm, 온도조절 디지털 회전 점도계



Remote Temp. Control Rotary Viscometer Full Set “WVT”

- Only need 2~16ml Sample Amount
- Ideal for measuring the Viscosity of Various Liquid such as Grease, Painting, Foodstuff, Dope, Paper making, Cosmetics, Chemical industry, Capsule Stickiness Agent and Medicines.
- Component of Set : Viscometer Unit “WVT”, Spindle Kit, Lifting Stand, Calibration Certificate
- Included ASTM Standard Spindle-kit of 4 Ea. :
 “WVT-0.33M” model - SC4(LV Range)
 21 : 5~15K, 27 : 25~250K, 28 : 50~500K, 29 : 100~1M
 “WVT-3.3M” model - SC4(RV Range)
 21 : 50~50K, 27 : 250~2.5M, 28 : 500~5M, 29 : 1K~10M
- Built-in High Precision Automatic Optimization Programmable Temperature Control Instrument
- Heating and Cooling, 0.1~8°C / Minute Arbitrary Adjustable
- Special Spindle, Guarantee Good Mixing Effect, No Precipitation
- Measurement Process and Data Analysis All Rely on the Computer Automatically
- The Disassembling Spindle and Measuring Cylinder Structure, Easy to Clean
- Available Pre-sets Speeds, 0.1~100 rpm
- Manual Lifting Positioning System, Ensure the Liquid Level Height Repeatability
- Special Spindle, Guarantee Good Mixing Effect, No Precipitation

- * Data on screen : • Speed Selected : RPM • Spindle Selected : S.P.
- Viscosity Reading : cP (mPa.s) • Percentage of Full Scale : %
- Sample Temperature : °C
- * Shear Rate (with special spindles) : SR • Shear Stress (with special spindles) : SS
- * Determination of Relative Viscosity and Absolute Viscosity
- * Viscosity Reading : Dynamic Viscosity (cP or mPa.s)
- * Determination of Shear Rate and Shear Stress with Coaxial Spindles.
- * The Viscometer and the PT100 can be calibrated by the User.
- * Ultra-sensitive front Keyboard that allows Easy Input of all Parameters.
- * Error Message in the Screen with Sound Alarm when the Viscosity of the Test Material exceeds the Full Scale of the selected Combination(SP/rpm.)
- * Sound Alarm if the Equipment is working at under 10% of selected Full Scale.

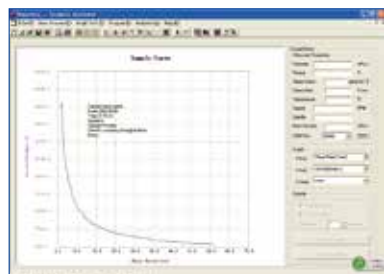

Viscosity Curve Analysis Software for “WVT-0.33M & 3.3M” Meter



(1) SC4 Spindle kit : Included for “WVT-0.33M & 3.3M” Meter



(2) Micro Printer, with Cable

Specifications & Ordering information

Spec.	Model	A. “WVT-0.33M” Max. Viscosity. 330,000cP	B. “WVT-3.3M” Max. Viscosity. 3,300,000cP
Viscosity Range cP(mPa.s)		5 ~ 330,000cP	50 ~ 3,300,000cP
Speed Range (RPM)		0.1 ~ 100	
Certificate		with Individual Calibration Certificate	
		Included ASTM Standard Spindle-kit, Stainless-steel	
ASTM Standard Spindle-kit & Measure Viscosity Range : cP	LV Range	RV Range	
	① SC4-21 : 5 ~ 5,000cP	① SC4-21 : 50 ~ 50,000cP	
	② SC4-27 : 25 ~ 250,000cP	② SC4-27 : 250 ~ 2,500,000cP	
	③ SC4-28 : 50 ~ 500,000cP	③ SC4-28 : 500 ~ 5,000,000cP	
	④ SC4-29 : 100 ~ 1,000,000cP	④ SC4-29 : 1000 ~ 10,000,000cP	
Temperature Range		-1°C ~ 150°C (Precision ±1.0°C)	
Measurement Error		±5% (Newton Liquid)	
Accuracy / Repeatability		±1.0% of range / ±0.5%	
Ambient Temperature		5°C ~ 35°C Relative Humidity : ≤80%	
Weight		14 kg	
Electrical Reqts.		Input AC 100~240V, 50/60Hz, Output DC17V 1.2A	
Cat. No.		DH.WV1041	DH.WV1042
Price, Each. ₩			

* K=1,000 cP(mPa.s), M=1,000,000 cP(mPa.s)

Spare Spindle-kit

	Ea. Price, ₩
DH.WV2031 (1) Standard SC4 Spindle kit, 21~29 LV Range - SC4-21 : 5~5K, 25 : 25~250K, 28 : 50~500K, 29 : 100~1M RV Range - SC4-21 : 50~50K, 25 : 250~2.5M, 28 : 500~5M, 29 : 1K~10M	

Optional Printer

	Ea. Price, ₩
DH.WV2043 (2) Micro Printer, with RS-232, USB 1.5m Cable (Print Information : Temp., RPM, Spindle, Torque, Viscosity)	

DAIHAN® Portable Rotary Viscometer-full Set “WVH-0.15M” & “WVH-0.3M”, 25~300,000cP
 With Calibration Certificate & Spindle-kit(B1~4), Hand Handling Case, Up to 200rpm, 포터블 디지털 회전 점도계



Portable Rotary Viscometer Full Set “WVH”

- Microcomputer Control Technique, User Friendly Interface
- Ideal for Measuring the Viscosity of Various Liquid such as Grease, Painting, Foodstuff, Dope, Paper making, Cosmetics, Chemical industry, Capsule Stickiness Agent and Medicines.
- Brand New and Humanized Design, Easy Operation, Accurate and Fast Measurement
- Calibration of Full Scale, Every Level Linearity
- New Design, Liquid Crystal Display, Prevent Slippery Handle, Overrange Alarm
- Display Temperature, Viscosity, Rotate Speed, Torsion in Percentage Serial Number of Rotor and the Maximum Viscosity of selected Rotor in Current Speed on LCD
- Unique Structure Design, Insure Useful Life and Measurement Accuracy
- AC / DC Power Supply in Two Design, Lithium Batteries Continuous Measuring Eight Hours without Charging
- Component of Set : Viscometer Unit “WVH”, Spindle Kit, Hand Handling Case, Calibration Certificate

- * Data on screen :
 - Speed Selected : RPM
 - Viscosity Reading : cP(mPa.s)
 - Sample Temperature : °C
 - Spindle Selected : S.P.
 - Percentage of Full Scale : %
- * Shear Rate (with special spindles) : SR
- * Shear Stress (with special spindles) : SS
- * Determination of Relative Viscosity and Absolute Viscosity
- * Viscosity Reading : Dynamic Viscosity (cP or mPa.s)
- * Error Message in the Screen with Sound Alarm when the Viscosity of the Test Material exceeds the Full Scale of the selected Combination(SP/rpm.)
- * Sound Alarm if the Equipment is working at under 10% of selected Full Scale.

Specifications & Ordering information

Spec.	Model	A. “WVH-0.15M” Max. Viscosity. 150,000cP	B. “WVH-0.3M” Max. Viscosity. 300,000cP
Viscosity Range cP(mPa.s)		25 ~ 150,000cP	50~300,000cP
Speed Range (RPM)		60 / 100 / 150 / 200	
Certificate		with Individual Calibration Certificate	
ASTM Standard Spindle-kit & Measure Viscosity Range : cP		Included ASTM Standard Spindle-kit, Stainless-steel	
	①	B1 : 25 ~ 883cP	① B1 : 50 ~ 1,666cP
	②	B2 : 90 ~ 3,000cP	② B2 : 180 ~ 6,000cP
	③	B3 : 165 ~ 55,000cP	③ B3 : 330 ~ 110,000cP
	④	B4 : 450 ~ 150,000cP	④ B4 : 900 ~ 300,000cP
Measurement Error		±5% (Newton Liquid)	
Accuracy / Repeatability		±2.0% of range / 1.0%	
Ambient Temperature		5°C ~ 35°C Relative Humidity : ≤80%	
Weight		3 kg	
Electrical Reqts.		AC 220V, 50/60Hz, Lithium Battery	
Cat. No.		DH.WV1051	DH.WV1052
Price, Each. ₩			

* K=1,000 cP(mPa.s), M =1,000,000 cP(mPa.s)

Spare Spindle-kit

DH.WV2011 (1) Standard Spindle kit, B1~4

Ea. Price, ₩



Lift Mode



Portable Mode

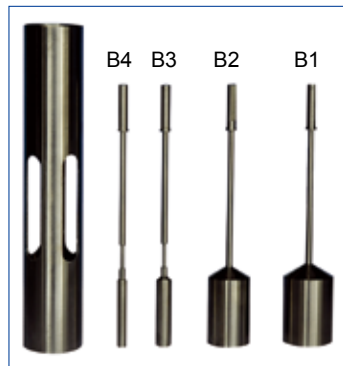

(1) Standard Spindle kit, B1~4
 Included for “WVH-0.15M & 0.3M” Meter

MaXcrub™

Glass/Labware Washer

Ideal for Laboratory Glass/Labware Washer

High
Performance
Cleaning

User
Safety

Program
Cycle

High-performance Cleaning

Outstanding fast cycle and high-performance cleaning results from efficient direct injection washing.

High performance pump ensure high flow rate of water.

Efficient water spray pressure bring about better and faster cleaning.

Water, liquid detergent and distilled water automatically injected by program washing cycle.

Safety Door Lock

Door is automatically locked for user safety when washing cycle starts.

Compact, Robust Design & Efficient Construction

- Compact design for space saving and maximize working capacity in laboratory.
- Double layer structure ensures soundproof and heatproof during operation.
- Built-in steam condenser prevents steam to enter into the laboratory.
- Telescopic sliding rails ensures safe and easy to load and unload.

Efficient Washing Cycle Program

- Provide 7 program washing cycles : Pre-set 6 programs & customized 1 program.

Pre-set 6 Program Cycles Setting Value

Pre-set 6 Washing Cycle	PreWash	Light Wash	Standard Wash	Light Demi	Standard Demi	Intense Wash
Tap Water Wash	3min	-	-	-	-	-
Detergent Wash	-	60°C / 8min	75°C / 8min	60°C / 5min	75°C / 5min	90°C / 10min
Rinse Wash	-	75°C / 5min	90°C / 5min	75°C / 3min	90°C / 3min	90°C / 5min
Distilled Water Wash	-	-	-	3min	3min	2min

Various Interchangeable Rack & Basket

- Included 1ea STS wire basket.
- Customizable various rack, Basket, Pipette rack, Volumetric flask rack, Direct injection kit, etc.

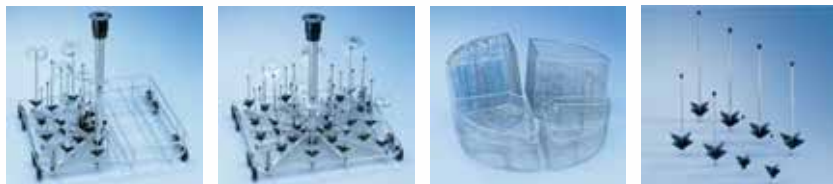

Irrigation Nozzle



Spray Arm

“MaXcrub™ T1” Glass/Labware Washer, Max 85 °C, Washing Surface 0.52m², 400Lit/min, Max 5bar
 With 1 × STS Wire Basket, Water-/Detergent-/Distilled Water-Auto Injection, Program Washing Cycle, Double Wall, Telescopic Rail, **초자 세척기**



Glass/Labware Washer “MaXcrub™ T1”

2-Year Warranty

- **Made in Korea** ■ **PL(Product Liability) Insurance.**
- **with Certificate & Traceability : Controlled by Serial Number, Certificate, Delivery-information, and Traceable Data Base System.**
- **Ideal for Clinical, Pharmaceutical, Bioresearch, Chemical Research, etc.**
- **Outstanding Fast Washing Cycle and High-performance Cleaning Results from Efficient Direct Injection Washing.**
- **Water-/Detergent-/Distilled Water- Automatically Injected into Wash Chamber via Pumps.**
- **Double Layer Wall ensures Soundproof and Heatproof.**
- **Automatic Door Lock system for User Safety.**
- **Special Steam Condensing Mechanism for User Safety.**
- * Built-in Telescopic Sliding Rail for Safety and Easy to Use.
- * Provides Efficient Program Washing Cycle : Pre-set 6Programs and Customizable 1Program.
- * Built-in Steam Condenser Prevents Steam to enter into the Laboratory.
- * Included 1ea STS Wire Basket .
- * Customizable Various Rack, Basket, Pipette Rack, Volumetric Flask Rack, Direct Injection Kit, etc.

Specifications & Ordering information

Spec.	Model	“MaXcrub™ T1”
Total Washing Surface		0.52m ²
Temp. Range		Room Temp +5°C to 85°C
Display		Digital LCD with Back-Light Function
Controller		Digital Fuzzy-Control System (Fully Automatic), Touch Button UI
Programmable Function		Pre-set 6 Programs & Customizable 1 Programs
Wash Pump		Recirculation : 400Lit/min, Water Pressure : 3~5bar, Water Consumption : 8~10Lit
Rack		Included 1ea Stainless-steel Standard Rack
Safety Circuit		Over-Temp./-Pressure/-Current protection, Sensor Error Detection
Material		Stainless-steel (#304)-Internal, Stainless-steel (#304)-External
Dimension (w × d × h)	Interior	508 × 515 × h407 mm
	Exterior	600 × 625 × h870 mm
Power Consumption		5 kW
Net Weight		95 kg
Electric Reqts.		1 Phase, AC 120 V, 60 Hz or AC 230 V, 50 / 60 Hz



Glass/Labware Washer “MaXcrub™ T1” with Optional Customizing Rack

2-Year Warranty

Cat. No.	60Hz	230V	DH.WGW0400
		120V	DH.WGW0401
	50Hz	230V	DH.WGW5400
Price, Each. ₩			

* Other Specifications are available upon Customer’s Request.

※ **Note! Freight and Installation Charges Separately.**



(1) (Included) STS Wire Basket



(2) STS Injection Rack

Spare Stainless-steel Standard Rack

DH.WGW01001 (1) STS Wire Basket, for Rail, 495 × 510mm

Ea. Price, ₩

Optional Stainless-steel Injection Rack for Various Vessel

DH.WGW01002 (2) STS Injection Rack for Various Vessel, 495 × 510mm

Ea. Price, ₩

Optional Stainless-steel Wire Rack, Use for Included Standard Rack

DH.WGW1003 (3) STS Wire Rack, for Various Vessel, 248 × 460 × h180mm
 DH.WGW1004 (4) , for Test Tube , 248 × 460 × h160mm
 DH.WGW1005 (5) , Mesh-type, for Petri Dish, 248 × 460 × h65mm

Ea. Price, ₩



(3) STS Rack, for Vessel

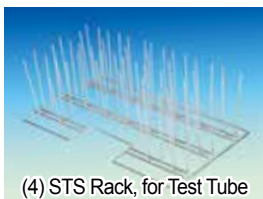

(4) STS Rack, for-Test Tube

Optional Liquid Cleaning Detergent & Rinse

DH.WGW02010 (6) Potassium Hydroxide Liquid Cleaning Detergent, 18Lit
 DH.WGW02011 (7) Nonionic Surfactant Liquid Rinse, 18Lit

Ea. Price, ₩



(5) Mesh-type STS Rack



(6) Cleaner (7) Rinse

Optional Liquid Detergent

Water Purification

Basic Water Still P. 257

Classic Water Still *New* P. 258~259

Water Purification System P. 260~262

- Reverse Osmosis(RO) P. 260
- Ultra Pure(UP) P. 261
- Ultra Pure(UP) & Pure(RO) P. 262

>> Water Still



“W4L” model
4Lit Basic Water Still,
with 304 Stainless-steel Heater



“WCS” model
4 & 8Lit Cabinet Water Still,
With Pure Silica / Quartz Heater



“CWS” model
With PP 1 μ m pore Cartridge Prefilter
3.5 & 7.5 Lit/hr

“WWS-P” model
With PP 1 μ m pore Cartridge Prefilter
4, 8, & 12 Lit/hr



>> Water Purification System



Reverse Osmosis(RO)
“New-P.NIX RO”



Ultra Pure(UP)
“New-P.NIX UP”



Ultra Pure(UP) & Pure(RO)
“New-P.NIX Power”

SciLab® Laboratory Basic Water Still “W4L”, with 304 Stainless-steel Heater, 4 Lit/hr, 3.0 ~ 4.0 $\mu\text{S}/\text{cm}$
 Suitable for Bench & Wall Mounting, Borosilicate Glass Boiler, 랩용 증류수 제조기



4Lit Basic Water Still, with 304 Stainless-steel Heater

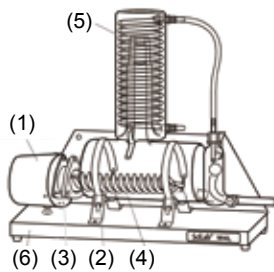

■ Supplied by SciLab Korea ■ Connect and Operate Directly from Tap Water

■ Heat Resistant Borosilicate Glass Boiler fitted with 3kW 304 Stainless-steel Heater.

- * High Efficiency Coil Condenser ensures Low Temperature, High Output Quality Distillate of Conductivity 3 to 4 $\mu\text{S}/\text{cm}$.
- * Compact Construction Suitable for Bench and wall Mounting
- * Built-in Constant Level Device with Schott Vendura-Nova Valve for Drainage provides Easy Descaling without Dismantling
- * Safety Thermostat Built into the Heater protects the Water Still in the Event of Water Supply Failure and Automatically Resets when the Water Supply is restored.
- * Borosilicate Glass Boiler and High-efficiency Condenser ensure the Highest in Distillate Purity.

Spec.	Model	“W4L”
Distillate Output		4 Liters/hour
Quality of Distillate : pH / Conductivity Resistivity / Temperature Pyrogen Content		5.0 ~ 6.5 pH / 3.0 ~ 4.0 $\mu\text{S}/\text{cm}$ 0.25 ~ 0.30 $\text{M}\Omega\cdot\text{cm}$ / 25 ~ 35°C Pyrogen Free
Water Supply Requirement		1 Liter/min, minimum 3psi (0.2 bar)
Dimensions (W×D×H), Weight		500×150×h450 mm, 5.25kg
Power Supply		220/240V, 50/60Hz, 3kW
Cat. No.		SL.Wat201
Price, Each. ₩		

Spare Accessory

	Ea. Price, ₩		Ea. Price, ₩
SL.Wat201.1 (1) Stainless-steel Heater		SL.Wat201.4 (4) Glass Boiler	
SL.Wat201.2 (2) Strap		SL.Wat201.5 (5) Condenser	
SL.Wat201.3 (3) Metal Flange		SL.Wat201.6 (6) Support Stand	

SciLab® Cabinet Water Still “WCS”, with Silica / Quartz Heater, Pyrogen-free, 4 & 8 Lit/hr, 1.2 ~ 2.0 $\mu\text{S}/\text{cm}$
 Suitable for Bench & Wall Mounting, Heat Resistant Borosilicate Glass Boiler, 케비닛형 증류수 제조기



4 & 8Lit. Cabinet Water Still, with Pure Silica / Quartz Heater.

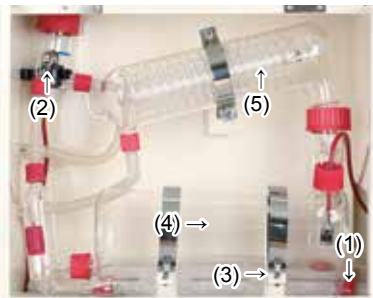

■ Supplied by SciLab Korea ■ Excellent Quality Glassware made from Borosilicate Glass

■ Safety Circuits cut off Electrical Power to Heaters and Trigger Audible and Visual Alarms in the Event of Water Supply Failure or High Boiler Temperature

- * Robustly built Epoxy-coated Steel Cabinet as Protective Housing adds a Touch Elegance to the Exquisite Water Still
- * Horizontal Thick Walled, Heat Resistant Borosilicate Glass Boiler fitted with two 1.5kW Silica Heaters
- * High Efficiency Coil Condenser ensures Low Temperature, High Output Quality Distillate
- * Screwthread Connectors enable Easy Fitting or Removal of Houses Safely and Leak Free Operation
- * Built-in Constant Level Device with Schott Vendura-Nova valve for Drainage provides Efficient Boiler operation, Over Flow Protection and Easy Descaling without Dismantling
- * Visual Flow Control Valve for Setting Water Supply Input for Maximum Operation Efficiency
- * Float Switch activates Safety Circuits in the Event of Water Supply Failure. Automatically resets when Water Supply is restored
- * Temperature-sensitive Thermal Switch as Back-up Protection which Activates Safety Circuits in the event of Abnormally High Boiler Temperature. Automatically resets when Boiler Temperature returns to Normal
- * High Quality Electrical Components from Reputable Manufacturers meeting International Specifications and Standards

Spec.	Model	“WCS4L”	“WCS8L”
Distillate Output		4 Liters/hour	8 Liters/hour
Quality of Distillate : pH Conductivity Pyrogen Content Temperature		5.0 ~ 6.5 pH 1.2 ~ 2.0 $\mu\text{S}/\text{cm}$ Pyrogen Free 25 ~ 35°C	
Water Supply Requirement		1 Liter/min, minimum 3psi (0.2 bar)	
Dimensions (W×D×H) , Weight		500×225×h395 mm, 14.90kg	500×330×h395 mm, 17.90kg
Power Supply		220/240V, 50/60Hz, 3kW	220/240V, 50/60Hz, 6kW
Cat. No.		SL.Wat203	SL.Wat205
Price, Each. ₩			

Spare Accessory for 4 & 8 Lit Common Use

	Ea. Price, ₩		Ea. Price, ₩
SL.Wat203.1 (1) Silica Heater		SL.Wat203.4 (4) Glass Boiler	
SL.Wat203.2 (2) Vertical Float Switch		SL.Wat203.5 (5) Condenser	
SL.Wat203.3 (3) Foam Strap			

DAIHAN® Electric Classic Water Still, "WWS", Built-in Prefilter & Auto On/Off system

For Laboratory Water, Pyrogen-free, 0.3MΩ·cm(resistivity), pH5.4 to 7.3, Capa. 4 · 8 · 12 Lit/hr

(1) with Stainless-steel 100 mesh Prefilter, (2) with PP 1μm pore Cartridge Prefilter, 필터부착형 증류수 제조기



(1) with Stainless-steel 100 mesh Prefilter, "WWS-S": 4 · 8 · 12 Lit/hr



(2) with PP 1μm pore Cartridge Prefilter, "WWS-P": 4 · 8 · 12 Lit/hr

- Made in Korea ■ 2-Year Warranty
 - High-performance / All Stainless-steel (SUS-430/304) models : Designed for the Durability & Consistent Quality
 - "WWS-S" models, Built-in Stainless-steel(SUS-304) Prefilter Kit, interchangeable 100 mesh (150μm) : Remove Particles & Scale-forming impurity.
 - "WWS-P" models, Built-in PP(Polypropylene) 1μm Prefilter / Cartridge Kit, interchangeable : Remove Rust, Particles & Scale-forming impurity.
 - All Models, Complete Set with :
 - ① Stainless-steel Unit Kit , ② External Consistent-Level Device,
 - ③ Drain Valve, ④ Prefilter Kit,
 - ⑤ 2m Feeding Water Tubing (Silicone) Assembly for Connection of Water Tap φ15 or φ19 mm,
 - ⑥ PP Un-equal Tapered Connector φ8,10,12 / 14,16mm-for Different Diameter Tubings
 - Auto On/Off with Water Level Sensor/Micro Level Sensor.
- * This space-saving horizontal condenser was designed for durability and consistent quality
- * Energy saving features include a condenser that preheats the feedwater and a double-walled evaporator.
- * A low water cutoff protects heating elements from burn-out when water supply is interrupted
- * Stainless-steel Heater Built-in 0.4mm Ni/Cr. Element, Boiler, Efficient Energy and Water Consumption.
- * Sealing : Silicone O-ring packing.

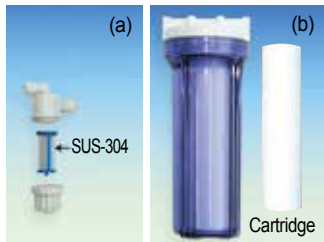

Stainless-steel Filter Kit & P.P Filter Kit



Ex> Installation of Water Still

Specifications & Ordering information

Spec.	Model	(1) With Stainless steel 100 mesh Prefilter			(2) With PP 1μm pore Cartridge Prefilter		
		"WWS-S4"	"WWS-S8"	"WWS-S12"	"WWS-P4"	"WWS-P8"	"WWS-P12"
Capacity(Water)		4 Lit/hr	8 Lit/hr	12 Lit/hr	4 Lit/hr	8 Lit/hr	12 Lit/hr
Filter	Function Material Housing Pore size Heat-resisting	Remove Particles & Scale-forming impurity Stainless-steel, SUS304 POM(Polyoxymethylene) 150μm(100 mesh) -29°C ~ +85°C			Remove Rust, Particles & Scale-forming impurity PP(Polypropylene) PE(Polyethylene) 1μm 85°C		
Water Purity		0.3MΩ·cm (resistivity), pH5.4 to 7.3					
Level Sensor		Auto On/Off with Water Level Sensor / Micro Level Sensor					
Material	Boiler Condenser Base	SUS-430 SUS-304 SUS-430	SUS-430 SUS-304 Aluminum	SUS-430 SUS-304 SUS-304	SUS-430 SUS-304 Aluminum	SUS-430 SUS-304 Aluminum	
Size	Condenser(only)	φ 85 × L375	φ 120 × L430	φ 120 × L490	φ 85 × L375	φ 120 × L430	φ 120 × L490
	Body	φ 350 × h670	φ 350 × h760	φ 350 × h760	φ 400 × h670	φ 400 × h760	φ 400 × h760
Heater		3kW	6kW (3kW × 2Ea)	9kW (3kW × 3Ea)	3kW	6kW (3kW × 2Ea)	9kW (3kW × 3Ea)
Plug Style		Plug Code "C"		Plug Code "F"		Plug Code "C"	
Electrical Reqts.		1 Phase, AC 220 V, 60 Hz					
Cat. No.	220V	DH.WWS01004	DH.WWS01008	DH.WWS01012	DH.WWS02004	DH.WWS02008	DH.WWS02012
Price, Each. ₩							

Spare Prefilter & Optional Storage Bottle

DH.WWS10101	(a) Spare, Stainless-steel 100 mesh Prefilter Kit, "SF101", POM Housing φ36×h61mm, SUS-304 Filter only φ22×h46mm	Ea. Price, ₩
DH.WWS10102	(b) , PP 1μm pore Cartridge Prefilter & Housing Kit, "PF102", PE Housing φ110×h300mm, PP Filter only φ60×h252mm	
DH.WWP.10PF	Spare, PP 1μm pore Cartridge Prefilter, "PF103", φ(od.) PP Filter 60×φ(id.) 30×h 252mm	
DH.WWS10104	, PE Housing only, "PF104", φ110×h 300mm	
SL.Bot3102	Optional, Bottle, HDPE, Aspiration, White, 5L, Neck id-φ70, φ200×h360mm	
SL.Bot3103	, 10L, -φ70, φ250×h460mm	
SL.Bot3104	, 20L, -φ95, φ300×h555mm	
SL.Bot3105	, 50L, -φ95, φ380×h700mm	

DAIHAN® 3.5 & 7.5 Lit/hr Electric Classic Water Still “CWS”, Compact Cabinet-type, All Stainless Steel **NEW**
 Good for Laboratory Water, Double Wall Still Chamber, Built-in PP 1 μ m pore Cartridge Prefilter, Auto On/Off System
 스텐레스 사각 증류수 제조기, 필터부착형



2-Year Warranty

3.5 & 7.5 Lit/hr Cabinet-type Water Still “CWS”

- Made in Korea
- All Stainless-steel for Corrosion Resistance
- Double-walled Chamber Structure for Protects Burn Injuries
- High-performance & Compact Design
- * Designed for the Durability & Consistent Quality
- * Built-in Interchangeable PP(Polypropylene) 1 μ m Prefilter Cartridge Kit
- * Condenser and Boiler are Separable for Easy Cleaning and Maintenance
- * Auto Heater On/Off with Water Level Sensor & OPT Sensor
- * Pre-filter Removes Rust, Particles & Scale-forming Impurity
- * Economical Energy and Water Consumption
- * Built in Low water Sensor for Protects Heating Elements
- * Sealing : Silicone Gasket

Specifications & Ordering information

Spec.	Model	“CWS-4”	“CWS-8”
Capacity		Max. 3.5 Lit / hr	Max. 7.5 Lit / hr
Cooling Water		30 ~ 50 Lit	60 ~ 80 Lit
Filter	Function	Remove Rust, Particles & Scale-forming Impurity	
	Material	PP (Polypropylene)	
	Housing	PC (Polycarbonate) Bottle + PP (Polypropylene) Lid	
	Pore size	1 μ m	
	Heat-resisting	85 $^{\circ}$ C	
Water Purity		0.3 μ Ω-cm (resistivity), pH5.4 to 7.3	
Level Sensor		Auto On / Off with Water Level Sensor / Micro Level Sensor	
Material	Interior	Stainless-steel	
	Exterior	Stainless-steel Hair Lined with Powder Coating	
	Heater	Stainless-steel Pipe	
Safety		Low Water & Over Temperature Protection, Electric Leakage Circuit Breaker	
Dimension(w × d × h)		430 × 315 × h570 mm	445 × 325 × h630 mm
Net Weight		12 kg	18 kg
Packing Size(w × d × h)		440 × 370 × h610 mm	450 × 380 × h670 mm
Gross Weight		13 kg	19 kg
Power Consumption		3 kW	6 kW
Plug Style		Plug Code “C”	Plug Code “F”
Electric Reqts.		220 V, 50 / 60 Hz, 1 Phase	
Cat. No.		DH.WatS8001	DH.WatS8002
Price, Each. ₩			

* Other Specifications are available upon Customer’s Request.

※ 운임 별도!



Plug Code“C”

Plug Code“F”



(1) Cartridge Prefilter & PE Housing



(2) HDPE Storage Bottle 5~50L

(1) Spare Prefilter

- DH.WatA1001 PP 1 μ m pore Cartridge Prefilter Housing Kit, “CWS-A1001”
- DH.WatA1002 PP 1 μ m pore Cartridge Prefilter Only, “CWS-A1002”
- DH.WatA1003 Housing Only, PC Bottle & PP Lid “CWS-A1003”

Ea. Price, ₩

(2) Optional HDPE Storage Bottle

- SL.Bot3102 Bottle, Aspiration, White, 5L , Neck id- ϕ 70, ϕ 200 × h360 mm
- SL.Bot3103 , 10L, - ϕ 70, ϕ 250 × h460 mm
- SL.Bot3104 , 20L, - ϕ 95, ϕ 300 × h555 mm
- SL.Bot3105 , 50L, - ϕ 95, ϕ 380 × h700 mm

Ea. Price, ₩

“New-P.NIX® RO(Reverse Osmosis)” Water Purification System, 15 · 25 · 35-L/hr

With Pretreatment System, 2-Steps of Filter Exchange Indicator, (RO) Product 0.2 ~ 30 μ S/cm, 순수 제조장치



Included Pretreatment System 'HMC-PT1'



5~50 Lit

5~50 Lit

(1) White, HDPE Aspiration Bottle

(2) Amber, HDPE Aspiration Bottle



(3) 14" Super A/C Filter

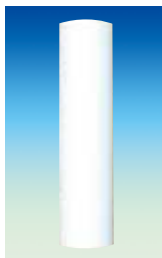

(4) 10" Prefilter



(5) P.NIX RO Pack I



(6), (7) P.NIX RO Pack II, III

- Made in Korea ■ Certified CE, ISO 9001, ISO 14001
- Built-In RS 232C Port and Volumetric Dispensing Function by Timer, Included Level sensor
- Auto Regular Recycling to Maintain the Optimum water Quality Level
- Programming by 2 Steps for the Filter Exchange
- Filter Replace Message Indicating by LCD Display & Blinking LED Light

- * Microprocess One Touch Technology Controller * 16×4 Characters Backlight LCD Digital Display
- * Awarded the Korean Excellent Products
- * Included Pretreatment System HMC-PT1, 14" Super A/C Filter, RO Pack

Specifications & Ordering information

Spec.	Model	“New-P.NIX RO 180” Max. Daily Volume. (Max. 60L/day)	“New-P.NIX RO 280” Max. Daily Volume. (Max. 100L/day)	“New-P.NIX RO 380” Max. Daily Volume. (Max. 120L/day)
Certified Mark	CE, ISO 9001, ISO 14001			
Product Flow Rate(RO)		Max. 15L/Hr.	Max. 25L/Hr.	Max. 35L/Hr.
Daily Volume		60L/day	100L/day	120L/day
Water Quality Display	• RO Product : 0.2 to 250.0 μ S/cm • Feed water : 10 to 1000 μ S/cm • Temperature : 0 to 99.9°C			
Display	16×4 Characters Backlight LCD Digital Display			
Controller	Microprocess One Touch Technology			
Dimensions (w×d×h)	300×460×h 470mm			
Power	210~230V, 50/60 Hz, 60W			
Cat. No.		DH.WWP.RO180	DH.WWP.RO280	DH.WWP.RO380
Price, Each. ₩				

Optional Accessory

				Ea.	Price, ₩
SL.Bot3102	(1) Bottle, HDPE, Aspiration, White,	5L, Neck id- ϕ 70, ϕ 200×h360mm			
SL.Bot3103		, 10L, - ϕ 70, ϕ 250×h460mm			
SL.Bot3104		, 20L, - ϕ 95, ϕ 300×h555mm			
SL.Bot3105		, 50L, - ϕ 95, ϕ 380×h700mm			
SL.Bot3106	(2) Bottle, HDPE, Aspiration, Amber,	5L, Neck id- ϕ 70, ϕ 200×h360mm			
SL.Bot3107		, 10L, - ϕ 70, ϕ 250×h460mm			
SL.Bot3108		, 20L, - ϕ 95, ϕ 300×h555mm			
SL.Bot3109		, 50L, - ϕ 95, ϕ 380×h700mm			

Spare Filter

Cat. No.	Description	Filter Replace Period	Ea. Price, ₩
DH.WWP.PR14AC	(3) 14" Super A/C Filter	Approx. 3~4 Month	
DH.WWP.10PF	(4) 10" Prefilter for HMC-PT1	20 ~ 40 Day	
DH.WWP.ROM1	(5) P.NIX RO Pack I for DH.WWP.RO180	Approx. 1 Year	
DH.WWP.ROM2	(6) P.NIX RO Pack II for DH.WWP.RO280		
DH.WWP.ROM3	(7) P.NIX RO Pack III for DH.WWP.RO380		

- The above mentioned Filter replacement period can be changed according to various factors such as feed water condition, producing volume and so on.

“New-PNIX® UP 900” Ultra Pure(UP) Water Purification System, Max 1.5L/min
 With Total Organic Carbon(TOC), 2-Steps of Filter Exchange Indicator, (UP) Up to 18.3MΩ·cm, **초순수 제조장치**



- **Made in Korea** ■ **Certified CE, ISO 9001, ISO 14001**
- **RS 232C Port and Volumetric Dispensing Function by Timer**
- **Auto Regular Recycling to Maintain the Optimum water Quality Level**
- **Programming by 2 Steps for the Filter Exchange**
- **Filter Replace Message Indicating by LCD Display & Blinking LED Light**

- * Microprocess One Touch Technology Controller
- * 16×4 Characters Backlight LCD Digital Display
- * Obtain GD, QD Mark, Awarded the Korean Excellent Products
- * Included 0.2 μ m Final Capsule Filter, UP Membrane Pack
- * Prerequisite : Pure Water is Required (DH.WWP.RO180)

Specifications & Ordering information

Spec.	Model	New-P.NIX UP 900			
		Scholar-type	UV-type	Bio-type	Integrate-type
Certified Mark		CE, ISO 9001, ISO 14001			
Product Flow Rate(UP)		Max. 1.5L/min			
Water Quality Display		• UP Product : Up to 18.3MΩ·cm • Feed water : 0 to 250 μ S/cm • Temperature : 0 to 99.9°C			
Display		16×4 Characters Backlight LCD Digital Display			
Included Filter Composition		• 0.2 μ m Final Capsule Filter • UP Pack (DH.WWP.UPS)	• 0.2 μ m Final Capsule Filter • UP Pack (DH.WWP.UPU) • 254/185UV Lamp	• 0.2 μ m Final Capsule Filter • UP Pack (DH.WWP.UPS) • MW 5000 UF Filter(L)	• 0.2 μ m Final Capsule Filter • UP Pack(DH.WWP.UPU) • 254/185UV Lamp • MW 5000 UF Filter(L)
Controller		Microprocess One Touch Technology			
Dimensions (w×d×h)		300×500×h 470mm			
Power		210~230V, 50/60 Hz			
Cat. No.		DH.WWP.UP.S	DH.WWP.UP.U	DH.WWP.UP.B	DH.WWP.UP.I
Price, Each. ₩					



(1) White, HDPE Aspiration Bottle (2) Amber, HDPE Aspiration Bottle



(3) 0.2 μ m Final Capsule Filter



(4) P.NIX UP Pack, Scholar / Bio



(5) P.NIX UP Pack, Scholar-UV / Integrate

• TOC monitoring system is also available for the Integrate-type on request. (TOC monitoring display range : 0~200ppb)

Optional Accessory

SL.Bot3102	(1) Bottle, HDPE, Aspiration, White,	5L, Neck id- ϕ 70, ϕ 200×h360mm
SL.Bot3103		, 10L, - ϕ 70, ϕ 250×h460mm
SL.Bot3104		, 20L, - ϕ 95, ϕ 300×h555mm
SL.Bot3105		, 50L, - ϕ 95, ϕ 380×h700mm
SL.Bot3106	(2) Bottle, HDPE, Aspiration, Amber,	5L, Neck id- ϕ 70, ϕ 200×h360mm
SL.Bot3107		, 10L, - ϕ 70, ϕ 250×h460mm
SL.Bot3108		, 20L, - ϕ 95, ϕ 300×h555mm
SL.Bot3109		, 50L, - ϕ 95, ϕ 380×h700mm

Ea.	Price, ₩

Spare Filter & UV Lamp

Cat. No.	Description	Filter Replace Period	Ea. Price, ₩
DH.WWP.0.2CF	(3) 0.2 μ m Final Capsule Filter	Approx. 6~8 Month	
DH.WWP.UPS	(4) P.NIX UP Pack, Scholar / Bio	Approx. 1 Year	
DH.WWP.UPU	(5) P.NIX UP Pack, Scholar-UV / Integrate		
DH.WWP.MWL	MW 5000 UF Filter(L)	Approx. 6~8 Month	
DH.WWP.UV	254/185 UV Lamp	Approx. 3 Year	

• The above mentioned Filter replacement period can be changed according to various factors such as feed water condition, producing volume and so on.

“New-P.NIX® Power” Ultra Pure(UP) & Pure(RO) Water Purification All-in-One System, Max 15L/hr

With Pretreatment System, 2-Steps of Filter Exchange Indicator, (RO) 0.2 ~ 250 μ S/cm, (UP) Up to 18.3M Ω -cm, 초순수/순수 제조장치



Included Pretreatment System 'HMC-PT-3'



(3) 10" A/C Filter (4) 10" Prefilter



(5) P.NIX RO Pack I



(6) 0.2 μ m Final Capsule Filter



(7), (8) P.NIX UP Pack

- Made in Korea ■ Certified CE, ISO 9001, ISO 14001
- Built-In RS 232C Port and Volumetric Dispensing Function by Timer, Included Level sensor
- Auto Regular Recycling to Maintain the Optimum water Quality Level
- Programming by 2 Steps for the Filter Exchange
- Filter Replace Message Indicating by LCD Display & Blinking LED Light
- Self-Diagnosis for Ext- & Int-System, Auto Cleaning, Auto Sensor Calibration

* Microprocess One Touch Technology Controller * 16×4 Characters Backlight LCD Digital Display

* Awarded the Korean Excellent Products

* Included Pretreatment System HMC-PT-3, RO Pack, UP Pack, 0.2 μ m Final Filter

Specifications & Ordering information

Spec.	Model	New-P.NIX Power I			
		Scholar-type	UV-type	Bio-type	Integrate-type
Certified Mark		CE, ISO 9001, ISO 14001			
Product Flow Rate (RO & UP)		Max. 15L/Hr.			
Water Quality Display		• Pure water(RO) : 0.2 ~ 250 μ S/cm • Ultra Pure water(UP) : Up to \leq 18.3M Ω -cm • Feed water : 0 to 990 μ S/cm • Temperature : 0 to 99.9 $^{\circ}$ C			
Included Filter Composition		• Pretreatment System HMC-PT-3 • RO Pack • 0.2 μ m Final Filter • UP Pack(Scholar)	• Pretreatment System HMC-PT-3 • RO Pack • 0.2 μ m Final Filter • UP Pack(S-UV) • 254/185 UV Lamp	• Pretreatment System HMC-PT-3 • RO Pack • 0.2 μ m Final Filter • UP Pack(BIO) • MW5000UF filter(M)	• Pretreatment System HMC-PT-3 • RO Pack • 0.2 μ m Final Filter • UP Pack(INT) • 254/185 UV Lamp • MW5000UF filter(M)
Display		16×4 Characters Backlight LCD Digital Display			
Controller		Microprocess One Touch Technology			
Dimensions (w×d×h)		395×500×h 470mm			
Power		210~230V, 50/60 Hz			
Cat. No.		DH.WWP.POWER.S	DH.WWP.POWER.U	DH.WWP.POWER.B	DH.WWP.POWER.I
Price, Each. ₩					

• Product Flow Rate 25L/Hr. and 35L/Hr. are also available on Request.

Optional Accessory

SL.Bot3102	(1) Bottle, HDPE, Aspiration, White, 5L, Neck id- ϕ 70, ϕ 200×h360mm
SL.Bot3103	, 10L, - ϕ 70, ϕ 250×h460mm
SL.Bot3104	, 20L, - ϕ 95, ϕ 300×h555mm
SL.Bot3105	, 50L, - ϕ 95, ϕ 380×h700mm
SL.Bot3106	(2) Bottle, HDPE, Aspiration, Amber, 5L, Neck id- ϕ 70, ϕ 200×h360mm
SL.Bot3107	, 10L, - ϕ 70, ϕ 250×h460mm
SL.Bot3108	, 20L, - ϕ 95, ϕ 300×h555mm
SL.Bot3109	, 50L, - ϕ 95, ϕ 380×h700mm

Ea.	Price, ₩

Spare Filter & UV Lamp

Cat. No.	Description	Filter Replace Period	Ea. Price, ₩
DH.WWP.PR10AC	(3) 10" A/C Filter	Approx. 3~4 Month	
DH.WWP.10PF	(4) 10" Prefilter for HMC-PT-3	20 ~ 40 Day	
DH.WWP.ROM1	(5) P.NIX RO Pack I	Approx. 1 Year	
DH.WWP.0.2CF	(6) 0.2 μ m Final Capsule Filter	Approx. 6~8 Month	
DH.WWP.UPS	(7) P.NIX UP Pack, Scholar/Bio	Approx. 1 Year	
DH.WWP.UPU	(8) P.NIX UP Pack, Scholar-UV/ Integrate	Approx. 1 Year	
DH.WWP.MWM	MW5000UF Filter (M)	Approx. 6~8 Month	
DH.WWP.UV	UV Lamp	Using time : 2000 Hrs	

• The above mentioned Filter replacement period can be changed according to various factors such as feed water condition, producing volume and so on.

CERTIFICATES

- ✓ Quality ✓ Safety
- ✓ Environment Management

- **CE** **EMC & LVD Compliance**
The Certified DAIHAN Laboratory Instruments are Specified in this Catalog
- **UL** **UL Certification**
Laboratory-use Electrical Equipment
for **General-type Incubators & Oven, B.O.D Incubators, Vacuum Ovens**
- **GD (Good Design) Mark**
- **GMP** **GMP Certification**
Good Manufacturing Practices of Medical Device
- **ISO 9001** **System Certification**
Design, Development, Manufacture & Servicing
for **All DAIHAN Laboratory Instruments**
- **ISO 13485** **System Certification**
Design, Development, Manufacture & Servicing
for **All DAIHAN Laboratory Instruments**
- **SQ (Service Qualification) Certification**



ALLforLAB.com Open-market
DAIHAN-Analy.com
DAIHAN-Sci.com Shopping-mall
DAIHANused.com
LabRental.co.kr
Lab-Service.co.kr



CE Certified
Excellent Service Quality - Certified
Global Small Giant Corp. of Korea
GMP Certified for Medical Instruments
ISO 9001 Certified
ISO 13485 Certified for Medical Instruments
UL Certified
PL Insurance
Validation (IQ & OQ) Service
Patented (No. 10-0554098)
Jog Dial Control System

DAIHAN Scientific Co., Ltd.

Address : 326, Sinpyeongseokhwa-ro, Jijeong-myeon,
Wonju-si, Gangwon-do, Republic of Korea

Tel : 080-008-3000 or 070-5020-1516

Fax : 033-737-7575

E-mail : daihan@daihansci.co.kr

International

Tel : +82-2-967-5235

Fax : +82-2-963-5231

E-mail : info@daihan-sci.com

Cat 268 (23 Jul. 2019)

Distributor